



Review article

Hydrokinetic energy harnessing technologies: A review

W.I. Ibrahim^b, M.R. Mohamed^{c,*}, R.M.T.R. Ismail^a, P.K. Leung^a, W.W. Xing^d, A.A. Shah^{a,*}^a Key Laboratory of Low-grade Energy Utilization Technologies and Systems, MOE, Chongqing University, Chongqing 400030, China^b Faculty of Electrical & Electronics Eng. Tech., Universiti Malaysia Pahang, 26600 Pekan, Malaysia^c College of Engineering, Universiti Malaysia Pahang, 26300 Kuantan, Malaysia^d School of Microelectronics, Beijing University of Aeronautics and Astronautics, No. 37 Xueyuan Road, Haidian District, 100191, China

ARTICLE INFO

Article history:

Received 12 August 2020

Received in revised form 21 March 2021

Accepted 3 April 2021

Available online 16 April 2021

Keywords:

Hydrokinetic systems

Energy harnessing

Turbines

Permanent Magnet Synchronous Generator

ABSTRACT

Energy harnessing from hydrokinetic systems has been explored over several centuries. With advancements in the technology in last decade, and the intermittent nature of other technologies for energy harvesting, interest in harnessing energy from water-based hydrokinetic systems has amplified. This paper reviews and studies the state-of-the-art of these systems in sea- and river-based applications. The history of development, working principles, different turbines classifications, and research prospects and opportunities are reviewed and discussed. We also conduct a survey of currently available commercial technologies. Elements of the design that need to be enhanced are presented in detail, along with further research prospects in areas related to the technology.

© 2021 Published by Elsevier Ltd. This is an open access article under the CC BY-NC-ND license (<http://creativecommons.org/licenses/by-nc-nd/4.0/>).

Contents

1. Introduction.....	2021
2. Hydrokinetic Energy Conversion Systems (HECS).....	2023
2.1. Comparison of hydrokinetic technology with other technologies.....	2023
2.2. Structure of hydrokinetic technology.....	2030
2.3. Concept and formulae for hydrokinetic technology.....	2030
2.4. Hydrokinetic technology classification.....	2030
2.4.1. Horizontal axis hydrokinetic turbines.....	2030
2.4.2. Vertical axis hydrokinetic turbines.....	2030
2.4.3. Cross-flow hydrokinetic turbines.....	2030
2.4.4. Venturi and gravitational vortex turbine.....	2031
2.4.5. Non-turbine hydrokinetic systems.....	2031
3. Survey on hydrokinetic technology.....	2031
3.1. Hydrokinetic technology in tidal and marine settings.....	2031
3.2. Hydrokinetic technology in rivers.....	2033
4. Research prospects in hydrokinetic technology.....	2033
4.1. Assessment studies.....	2033
4.2. Broader research on hydrokinetic turbines.....	2033
4.3. Other research trends in hydrokinetic systems.....	2037
5. Conclusions.....	2040
Declaration of competing interest.....	2040
Acknowledgements.....	2040
References.....	2040

1. Introduction

The depletion of fossil fuels, high CO₂ emissions, global warming, and environmental pollution are the main factors motivating the drive towards renewable energy (RE) technologies as clean and sustainable sources for electricity generation (Gholikhani

* Corresponding authors.

E-mail addresses: rusllim@ump.edu.my (M.R. Mohamed), akeelshah@cqu.edu.cn (A.A. Shah).

Nomenclature

C_p	Power Coefficient
CEC	Current Energy Converter
EMEC	European Marine Energy Centre
FIV	Flow Induce Vibration
HECS	Hydrokinetic Energy Conversion System
ITDG	Intermediate Technology Development Group
MCT	Marine Current Turbine
ORPC	Ocean Renewable Power Company
PMSG	Permanent Magnet Synchronous Generator
RE	Renewable Energy
RECS	River Energy Conversion System
TISEC	Tidal-in Stream Energy Converters
TSR	Tip Speed Ratio
VIV	Vortex-Induced Vibration
WCT	Water Current Turbine
WEC	Wave Energy Converter
WECS	Wind Energy Conversion System
V	Water velocity ($m\ s^{-1}$)
M	Mass of water
ρ	Water density ($1000\ kg/m^3$)
V	Water volume
P	Power (W)
E	Kinetic Energy
P_T	Power develop at the rotor (W)
A	Swept Area of turbine (m^2)
F	Thrust Force
T	Torque (N m)
R	Radius of rotor
T_T	Actual torque of rotor
C_T	Torque Coefficient
λ	Tip Speed Ratio
ω	Angular speed of rotor
β	Pitch Angle
H	Head
Q	Flowrate

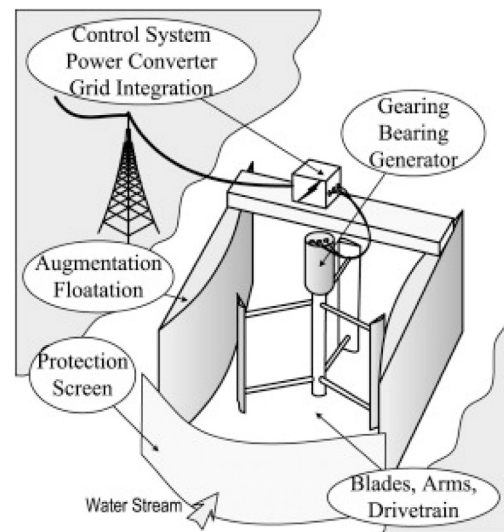

Fig. 1. The framework of a hydrokinetic system.
Source: Adapted from Khan et al. (2009).

A hydrokinetic system is an electromechanical device that converts the kinetic energy of water flow into electrical energy through a generator and power electronics converter, as illustrated in Fig. 1 (Khan et al., 2008). Even though the output capacity is small, capacity can be increased by an array or modular installation (Alvarez Alvarez et al., 2018; Shafei M.A.R et al., 2015). In addition, a hydrokinetic system is based on free-flowing water without the construction of a reservoir or impoundment. The system is easy to transport and relocate due to the small size of the plant. Moreover, the system can be installed along the riverside either mooring to a fixed structure or on a floating pontoon (Anyi and Kirke, 2010).

Nevertheless, despite its benefits, enormous research efforts are still necessary in order to improve hydrokinetic technology, especially for energy conversion applications. Areas of research that require further attention include (but are not limited to) the turbine selection and enhancement, assessment studies, energy conversion efficiency, and environmental impacts. Hydrokinetic systems continue to receive significant attention from researchers in order to improve the technology, reduce the barriers to implementation, gain further insights and understand the limitations of the technology.

Several previous reviews have appeared on hydrokinetic technologies (Khan et al., 2009; Lago et al., 2010; Güney and Kaygusuz, 2010; Yuce and Muratoglu, 2015; Laws and Epps, 2016; Kumar and Sarkar, 2016; Niebuhr et al., 2019). In Khan et al. (2009) and Lago et al. (2010) the authors focus on classifications and comparisons of energy conversion mechanisms. In Güney and Kaygusuz (2010), a categorisation of hydrokinetic turbines and recommendations for the suitability of turbines for river and tidal settings is presented. Environmental impacts and turbine performance were discussed in Yuce and Muratoglu (2015) and Kumar and Sarkar (2016) respectively, while in Laws and Epps (2016) and Niebuhr et al. (2019), modelling, turbine design and enhancement are discussed and reviewed. As far as authors are aware, updated research on hydrokinetic technologies for tidal, marine and river settings are scattered in the literature. Moreover, the research prospects for hydrokinetic systems are rarely discussed. Therefore, in this paper, the state-of-the-art of hydrokinetic technologies and the research trends are reviewed; since these technologies are emerging and expanding worldwide, this review provides a timely and concise description of

et al., 2020; Andrade Furtado et al., 2020; Camera, 2019). Currently, RE meets almost 25% of world energy demand with 6321 TWh electricity generation (IEA, 2018).

Renewable energy resources such as wind energy, solar PV, hydropower, geothermal, and bioenergy have been explored by researchers and private industries worldwide (Yao et al., 2021; Zahedi et al., 2021). Nevertheless, RE resources have a number of limitations, especially intermittent sources such as wind energy and solar (Li et al., 2021), which are not suitable to sufficiently reliable to fulfil base energy load demand. Hydropower and geothermal energy require specific geological conditions, involve high initial capital costs and can severely impact local environments (Kadier et al., 2018). Bioenergy requires complex engineering processes and advanced technology in the energy conversion schemes, and there is doubt about its carbon neutrality when taking into account the full life cycle (Scarlat and Dallem, 2018). As a result, energy harnessing based on, e.g., free-flowing water streams, i.e., the hydrokinetic systems, are promising for the delivery of clean, safe and sustainable energy, especially in remote areas that do not have access to grid power.

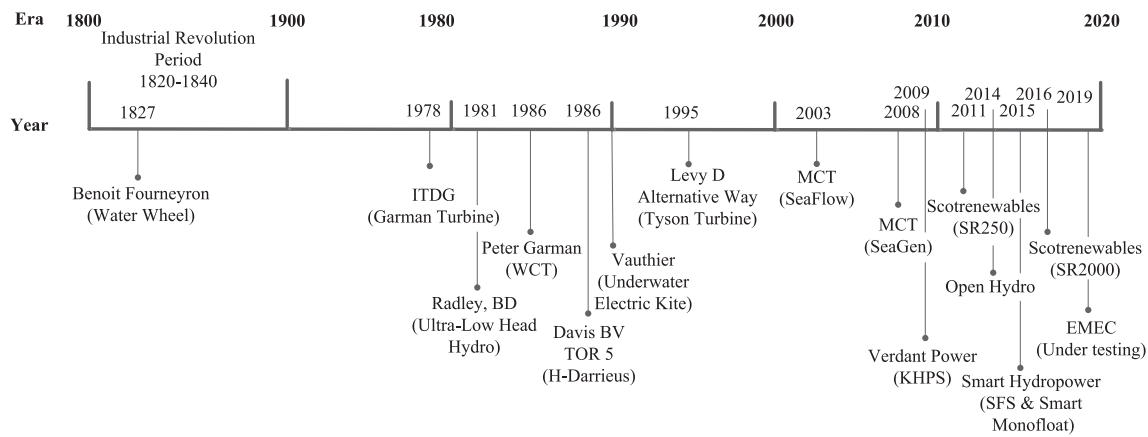

Fig. 2. Time-line of development and progress of hydrokinetic systems (not exhaustive).

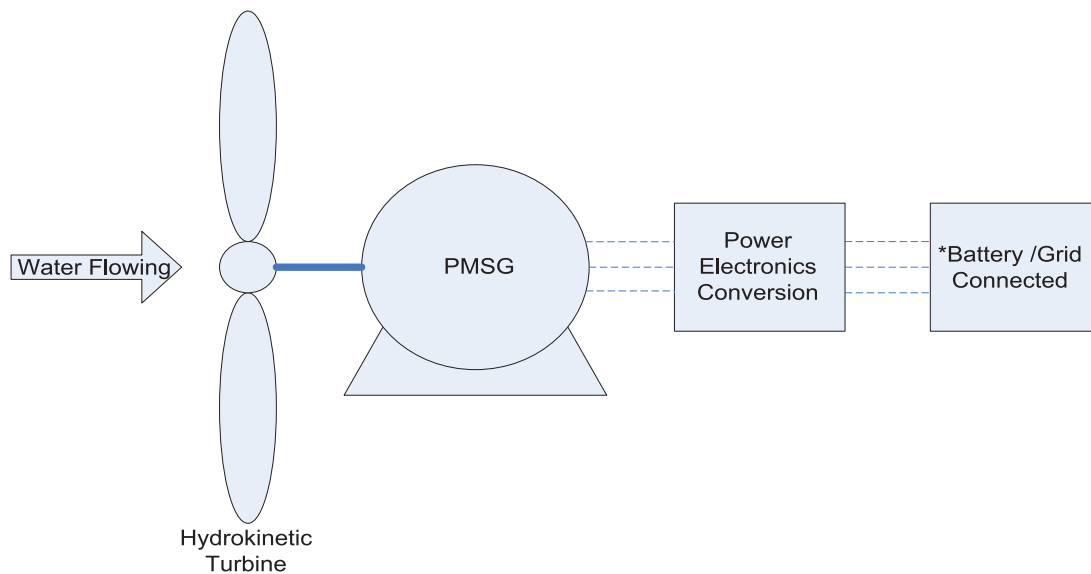

Fig. 3. The structure of a hydrokinetic system. (The high-end system either as stand-alone or grid connected).

their current status and of the focus for future development and research.

This review is organised as follows. Section 2 provides an overview of hydrokinetic systems, including their history, structure, and fundamental underlying mechanisms. Section 3 reviews hydrokinetic systems in tidal, marine and river settings. Research prospects and research trends in hydrokinetic systems are provided in Section 4 and in Section 5 we summarise and draw conclusions.

2. Hydrokinetic Energy Conversion Systems (HECS)

Water currents have been used as sources of energy for over a century. One of the technologies using water flow is the watermill. The system consists of a water wheel or water turbine to drive a mechanical process such as grinding, rolling, and hammering. These technologies have been installed at fast-flowing rivers for food, textile and paper production, amongst other applications (Tanier-Gesner et al., 2014). Electricity can also be generated using the flow of water.

Fig. 2 shows a rough timeline of the development and progress of hydrokinetic systems. Based on the literature, energy harnessing from free stream rivers is attributed to Peter Garman, who developed the Water Current Turbine (WCT) (Peter Garman,

1986). The WCT is used for water pumping and electricity generation in remote areas. In 1978, the Intermediate Technology Development Group (ITDG) developed the Garman Turbine for water pumping and irrigation.

During the early 1980s, a free rotor with 15 kW output power at 3.87 ms^{-1} water velocity was installed by the US Department of Energy for an ultra-low head hydro energy program as reported in R and H (1981). In 1986, the In-Stream Turbine with the straight blade Darrieus Turbine was designed by Nova Energy Systems and ITDG. The system is able to harness 0.5 kW output power at a flow speed of 1 ms^{-1} . Experiments on the use of WCT for electricity generation and irrigation have been carried out in several countries, such as Canada (Davis, 1989), Zaire and Australia (Levy, 1995). The straight blade Darrieus turbine has been used in Canada and Africa with 5 kW and 15 kW output power respectively. Alternative Way, Australia developed the horizontal axis Tyson Turbine with the generator submerged under water. In 1990 the idea to manipulate WCT technology for large scales emerged (Güney and Kaygusuz, 2010).

2.1. Comparison of hydrokinetic technology with other technologies

As one of the promising renewable energy technologies, the HECS offers an economical and reliable option for remote and off-grid areas, compared to conventional hydropower. Conventional

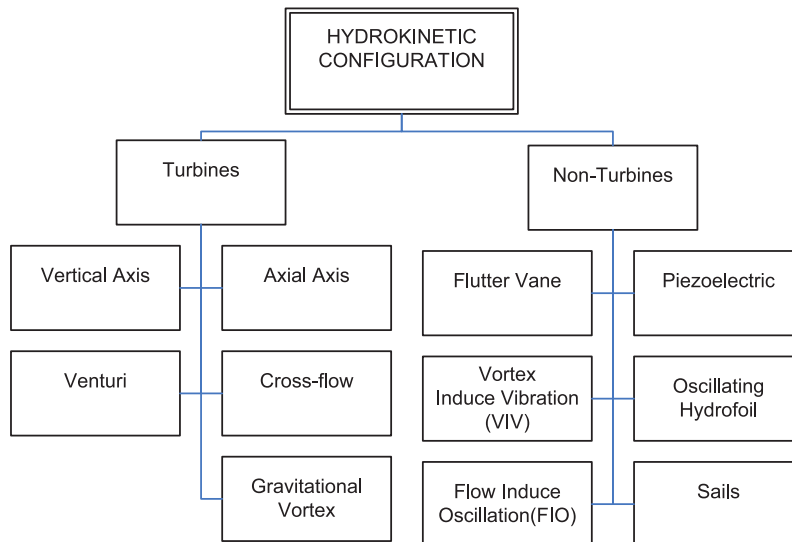
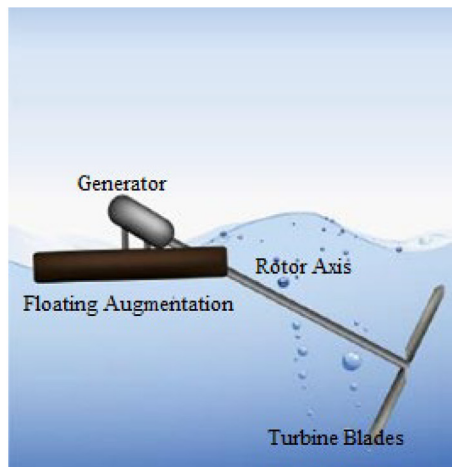
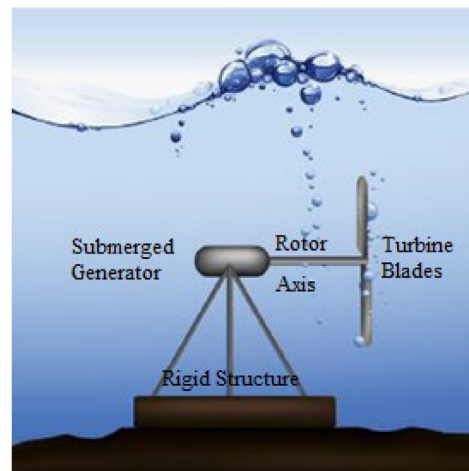

Fig. 4. Hydrokinetic configuration under the turbine and non-turbine classification.



(a) Inclined Axis



(b) Rigid Mooring

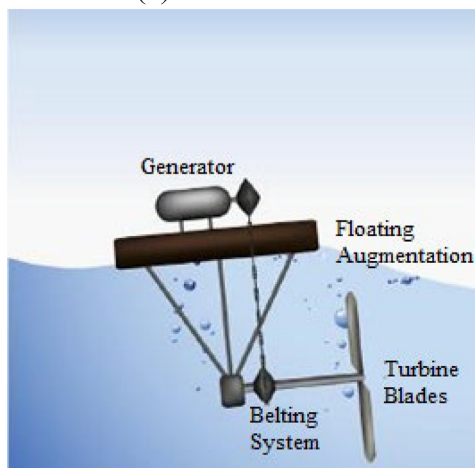

(c) Non-Submerged Generator

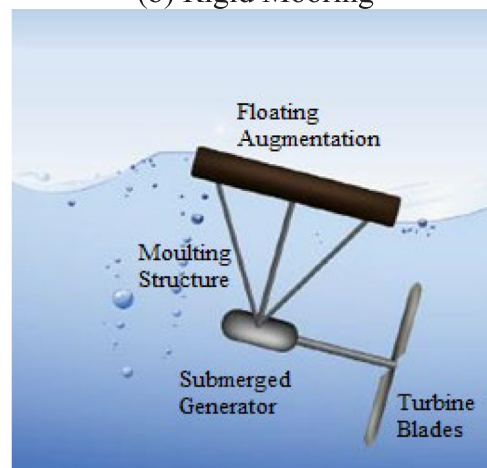

(d) Submerged-generator

Fig. 5. Horizontal axis turbines.
Source: Adapted from Behrouzi et al. (2016).



(a) Squirrel Cage Darrieus

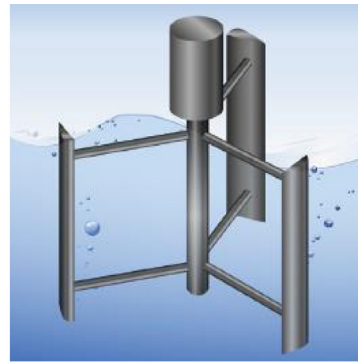

(b) H-Darrieus



(c) Darrieus

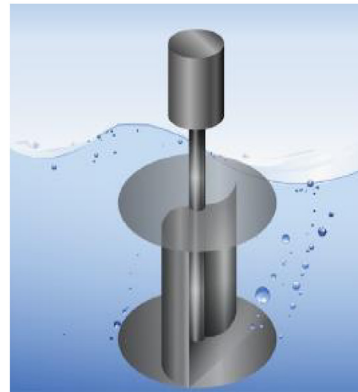

(d) Savonius

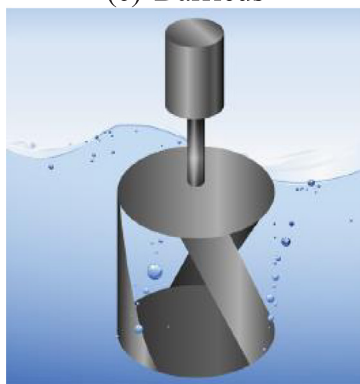

(e) Gorlov

Fig. 6. Vertical axis turbine.
Source: Adapted from Behrouzi et al. (2016).

hydropower requires a head (H) and flow rate (Q), and the output power is proportional to both parameters (Mishra et al., 2015). In contrast, HECS does not require a head, large dam or reservoir to operate, and a free stream velocity as low as 0.3 m/s is acceptable in order to rotate the small turbine (Sarma et al., 2014).

The construction of large conventional hydropower can have a negative impact on the local environment and ecosystem. Sovacool and Bulan (2012) reported that more than 1600 protected plants and 300 rare and endangered species are threatened due to the development of the Bakun hydropower in Sarawak. In addition, Izadyar et al. (2016) reported on the relocation of high numbers of indigenous people to enable hydropower plant

construction. In contrast, HECS has little if any impact on flora and fauna (Petrie et al., 2014). According to Güney and Kaygusuz (2010), HECS is environmentally friendly and water-life friendly. For example, several researchers have investigated the impact of hydrokinetic turbines on fish. Romero-Gomez and Richmond (2014) reported that the survival rates of fish following blade strike is higher than 96% and better than conventional hydropower. Schramm et al. (2017) reported that the behaviour of fish was not altered due to the turbine sound emission.

Even though the capacity for power generation of hydrokinetic systems is small compared to conventional hydropower, using an array system or hydrokinetic farm, the capacity of HECS can be

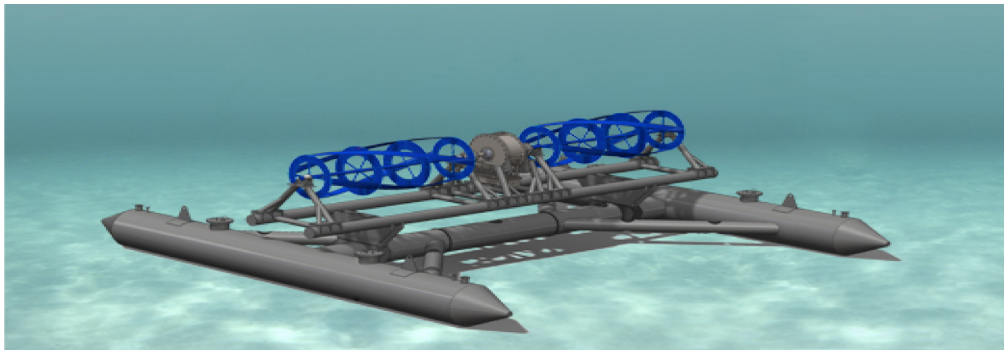

(a) RivGen

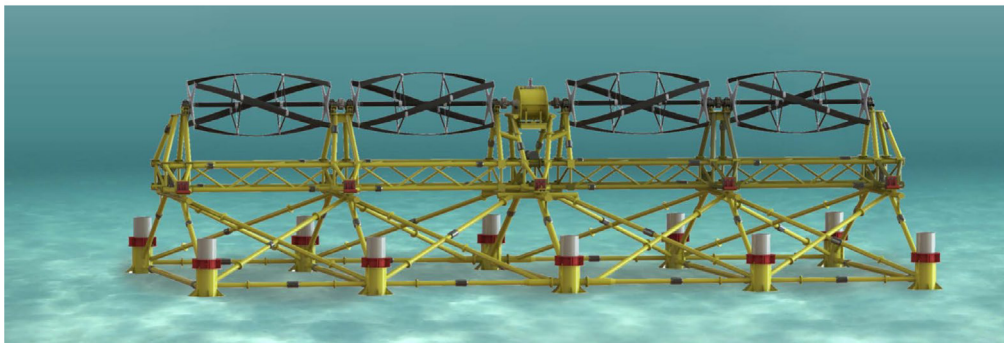

(b) TidGen

Fig. 7. The Cross-flow turbine produced by The RivGen and TidGen.
Source: Adapted from [TidGen Power Generation \(2019\)](#).

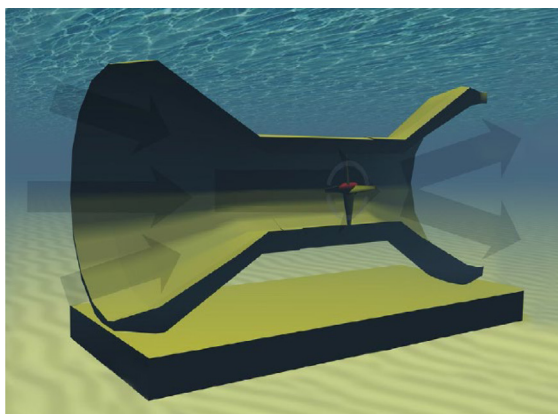

(a) Venturi effect turbine

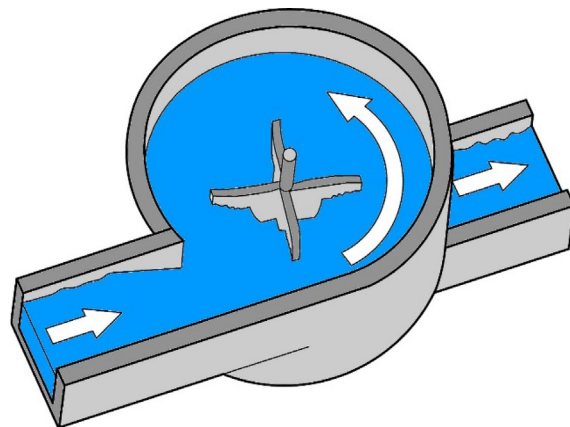

(b) Vortex type turbine

Fig. 8. The venturi and gravitational vortex turbine.

increased up to 100 MW ([Laws and Epps, 2016](#)). Several studies have reported on hydrokinetic array systems. For example, [Vennell et al. \(2015\)](#) proposed a design layout for macro–micro array turbines in HECS. The controller and details design for a modular hydrokinetic system connected to a smart grid was presented in [Alvarez Alvarez et al. \(2018\)](#).

On the other hand, most researchers, such as [Behrouzi et al. \(2016\)](#), [Kumar and Chatterjee \(2016\)](#) and [Vermaak et al. \(2014\)](#) have reported that a hydrokinetic system is similar to the wind turbine system in terms of concept, operation and electrical hardware. In addition, [Bahaj and Myers \(2003\)](#) identified that with the water velocity between $2\text{--}3\text{ ms}^{-1}$, a hydrokinetic system is able

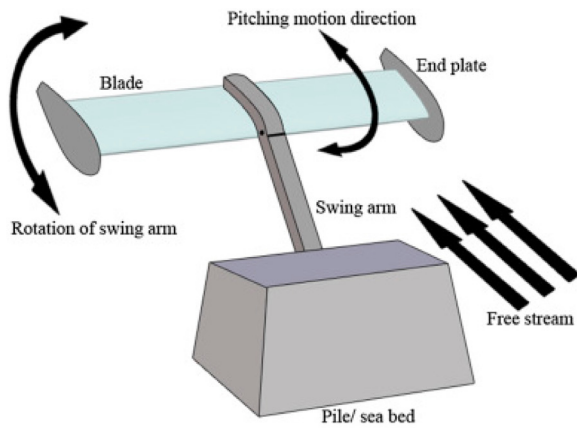

(a) The flapping foils

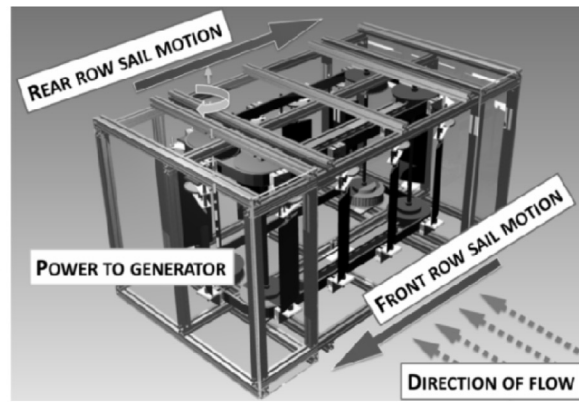

(b) Sails

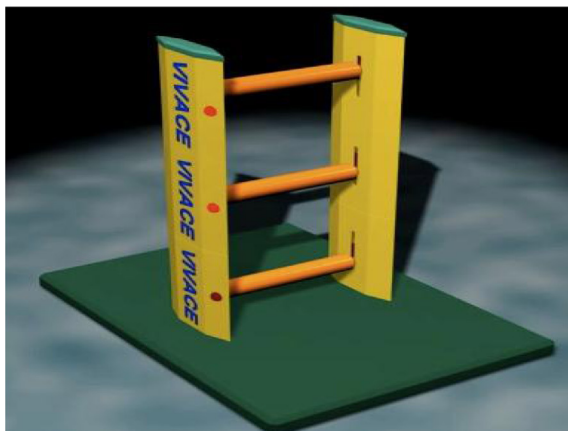

(c) VIVACE converter [66]

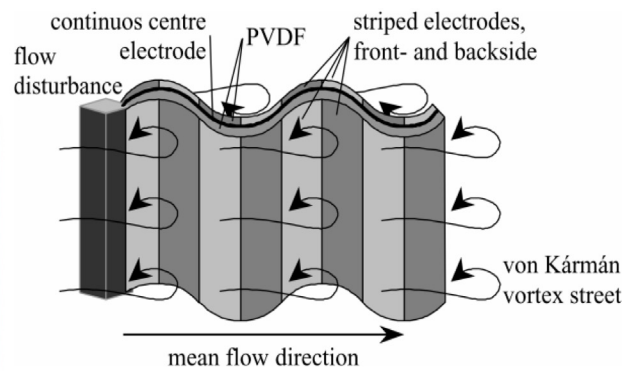

(d) The flutter flag

Fig. 9. Non-turbine system for energy conversion in the water (Karin, 2019).

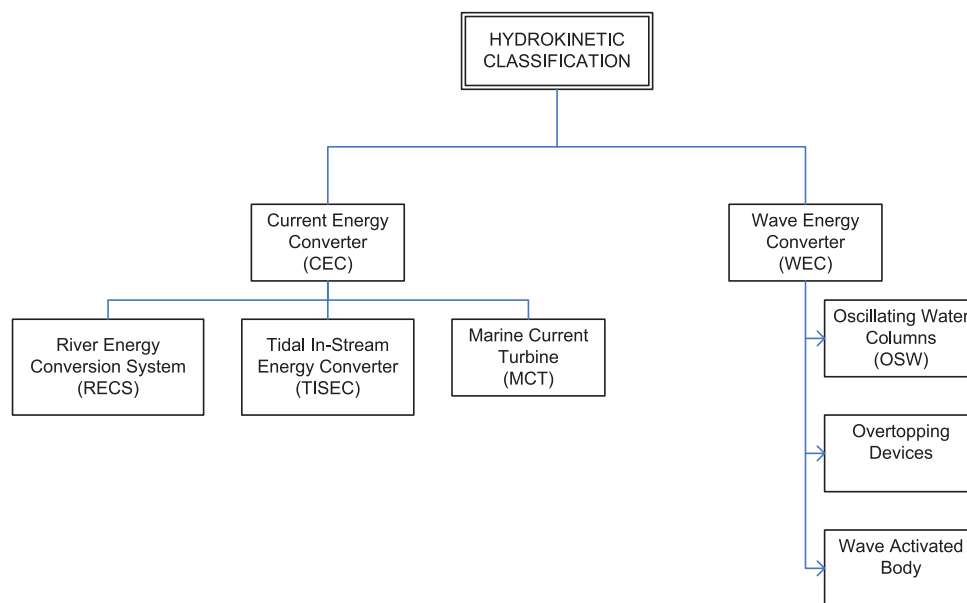

Fig. 10. The classification of hydrokinetic energy harnessing technology based on the working principle and energy conversion.



(a) SeaFlow Tidal Turbine



(b) SeaGen Tidal Turbine



(c) Verdant Power Tidal Turbine

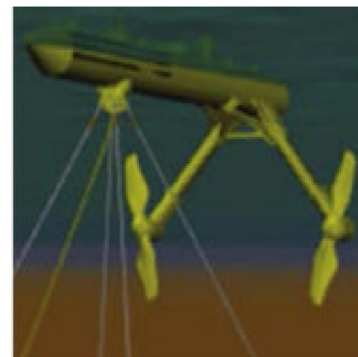

(d) Scotrenewables Tidal Turbine



(e) RER Hydro Tidal Turbine



(f) Nauticity Colmat Tidal Turbine

Fig. 11. Various marine hydrokinetic technologies.

to generate four times the output power compared to a similarly rated wind turbine. In other words, the size of the hydrokinetic turbine could be much smaller than that of a WECS with the same output power. This is because the density of water is 800 times that of air (Zupone et al., 2015; Marine Renewables Canada, 2018).

The significant difference between HECS and WECS is the range of Tip Speed Ratio (TSR). Ginter and Pieper (2011) reported that HECS has a lower TSR than WECS. The optimal TSR for

WECS is typically between 5 to 6. In contrast, the TSR value for HECS is less than 2.5 to avoid cavitation (Salter, 2005). Furthermore, Romero-Gomez and Richmond (2014) reported that HECS is less dependent on weather conditions compared to WECS. The direction and velocity of water are practically fixed and can be predicted much more reliably than wind velocity and direction (Shahsavari et al., 2015). On the contrary, the atmosphere is a highly non-linear system in which the speed and direction of

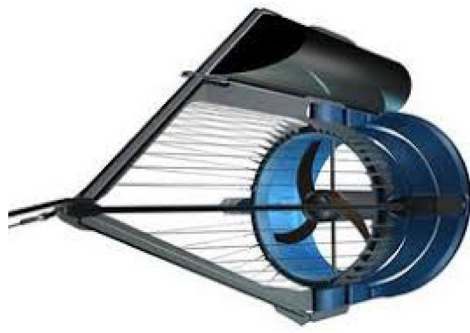

(a) Smart Monofloat River Turbine



(b) Smart Free Stream River Turbine

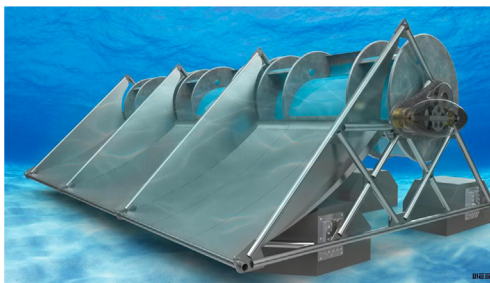

(c) Waterrotor River Turbine



(d) Idenergy River Turbine

Fig. 12. Various river turbines in commercial and pre-commercial status.

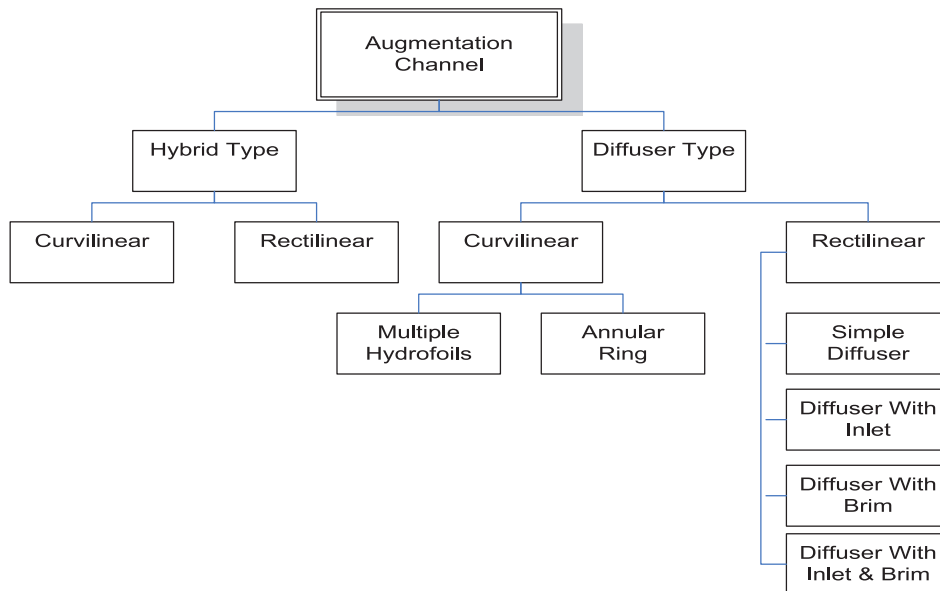

Fig. 13. The classification of augmentation channels.

wind are influenced by changes in air pressure, air temperature and the earth's rotation, amongst other factors (Barber, 2019).

Conversely, Muljadi et al. (2016) found that the level of turbulence in the air and water are similar for HECS and WECS.

Highly turbulence flow will affect the efficiency of the system and reduce the output power (Hamta et al., 2013). It will also increase mechanical stresses, inducing significant fatigue of the physical components of both systems. The turbine design and the use of a

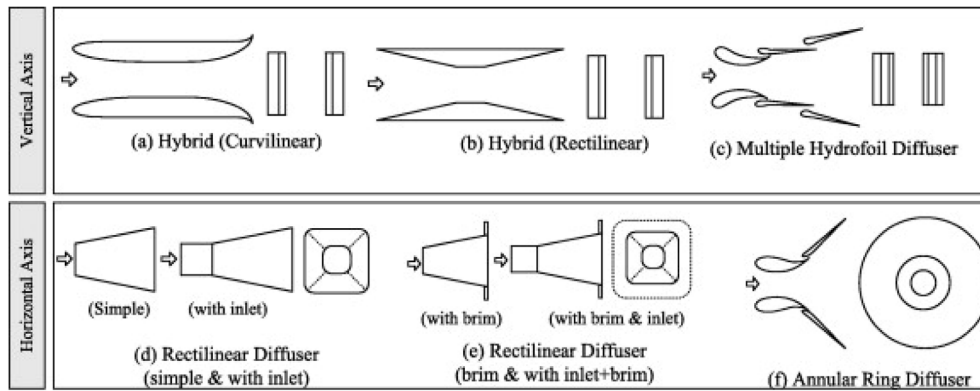

Fig. 14. Augmentation Channel shape on top and side view.
Source: Adapted from Behrouzi et al. (2016).

control strategy, such as maximum power point tracking (MPPT), pitch control and robust control, are important for reducing the mechanical stress and fatigue due to turbulent effects in harsh marine environments.

2.2. Structure of hydrokinetic technology

A hydrokinetic system consists of a hydrokinetic turbine, a generator (Permanent Magnet Synchronous Generator (PMSG)), power electronics converter, and battery or grid-tie connection system, as shown in Fig. 3. The flowing water is able to rotate the turbine at a certain velocity. The PMSG rotor is coupled to the turbine shaft directly without a gearing system, and the movement automatically turns the generator rotor. The output power from the PMSG is controlled and converted by the power electronics conversion system. In the stand-alone system, the variable AC (three-phase) system converts to the variable DC voltage through three-phase rectifiers. Then, the DC–DC converter converts the variable DC voltage into a constant DC bus voltage. In contrast, in the grid-tie connection system, an inverter is used to convert the constant DC bus voltage into AC power prior transporting it to the grid system.

2.3. Concept and formulae for hydrokinetic technology

The efficacy of hydrokinetic turbines to generate power depends on the water density (ρ), turbine power coefficient, cross-sectional area, and water velocity (Vermaak et al., 2014; Sornes, 2010). The ideal kinetic energy of the hydrokinetic system is given in Eq. (1)

$$P_m = \frac{1}{2} \rho A C_p V^3 \quad (1)$$

where P_m is the power developed by the rotor, A is the area swept out by the turbine rotor, V is the stream velocity, and C_p is the power coefficient of the turbine.

The C_p is the percentage of power that the turbine can extract from the water flowing through the turbine. According to studies carried out by Betz, the theoretical maximum amount of power that can be extracted from a fluid flow is about 59%, which is referred to as the Betz limit (Vermaak et al., 2014). In addition, The C_p of the turbine is a function of the Tip Speed Ratio (TSR) which is the ratio of the linear speed of the tip of the blade to the water speed

$$TSR(\lambda) = \frac{\omega_m R}{V} \quad (2)$$

where R is the turbine radius and ω_m is the turbine rotational speed. The mechanical torque (T_m) can be determined by Eq. (3).

$$T_m = \frac{P_m}{\omega_m} \quad (3)$$

2.4. Hydrokinetic technology classification

As an emerging technology in renewable energy, the hydrokinetic system can be classified based on the energy conversion scheme and the working principle of the system. Khan et al. (2009) and Lago et al. (2010) have classified the hydrokinetic technology into two classes based on the conversion scheme: the first uses a turbine and the second is a non-turbine system. Fig. 4. shows the hydrokinetic configuration under the turbine and non-turbine classification.

2.4.1. Horizontal axis hydrokinetic turbines

Conversion schemes using turbines, such as the horizontal axis, vertical axis, and cross-flow are widely used in HECS as reported in Elbatran et al. (2015). According to Magagna and Uihlein (2015), the horizontal axis turbine has dominated almost 76% of the research and development into turbine design worldwide. In the horizontal axis turbine, the rotational axis is parallel or inclined towards the direction of the flowing water, as shown in Fig. 5(a)–(d). The advantage of a horizontal axis turbine is that the turbine has a self-starting capability for slow water currents (Koko et al., 2015). Nevertheless, the turbine clogs easily with debris in the river, and the cost of manufacturing is higher than that of the vertical axis turbine.

2.4.2. Vertical axis hydrokinetic turbines

The vertical axis turbine is commonly used to extract the kinetic energy in the rivers (Behrouzi et al., 2016). The vertical-axis turbines as shown in (Fig. 6) have the rotor's axis of rotation is at a right angle to the surface of the water (Khalid et al., 2013). This property means that vertical-axis turbines can do without a yawing device since it can handle incoming flows from any direction. Besides, the turbines are quieter in operation, and the mechanical complexity has been reduced. Furthermore, this type of turbine requires no gearing coupling, and the costs will decrease because of placement above water (Birjandi et al., 2012).

2.4.3. Cross-flow hydrokinetic turbines

The cross-flow turbine has an orthogonal rotor axis with respect to the flow of water but parallel with reference to the surface of the water (Laws and Epps, 2016). The cross-flow turbine can operate without the yawing mechanism, similar to vertical

axis turbine (Bachant and Wosnik, 2015). In addition, cross-flow turbines are preferable for use in hydrokinetic farms or arrays by virtue of being more economical in terms of space, and the rectangular swept area will increase the output power (Cavagnaro, 2016). This turbine is also operated at a lower speed, and as a result it will reduce cavitation, lower noise levels and is safer for marine animals (Forbush et al., 2017). As noted in Saini and Saini (2019) the configuration of a cross-flow turbine can be classified into three groups based on lift force, drag force and combination of lift and drag force.

Fig. 7 shows an example of the cross-flow turbine, developed by Ocean Renewable Power Company (ORPC). ORPC was founded in 2004 in Florida and is one of the most active companies in marine renewable energy. In 2015, ORPC successfully installed the RivGen in a remote Alaskan village. The company also installed the first grid-connected hydrokinetic system to harness tidal energy, using the TidGen at Eastern Maine in 2012 (ORPC, 2019).

2.4.4. Venturi and gravitational vortex turbine

The venturi turbine can be applied at low water velocity with shallow water depth (Neill and Hashemi, 2018). As can be seen in Fig. 8(a), the venturi concept is based on funnel-like devices. Therefore, it will increase the water velocity and decrease the pressure subsequently driving a turbine. On the other hand, the vortex turbine is able to generate power at low head and low flowrate using gravitational vortices (Nishi et al., 2020). The vortex turbine design required a round basin with a central drain as shown in Fig. 8(b) (Loots et al., 2015). The rotational energy of the vortex will drive the generator to produce the energy.

2.4.5. Non-turbine hydrokinetic systems

A non-turbine system can also be used to extract power from marine, river, or open channel flows. The flapping foil, as shown in Fig. 9(a) is inspired by the motion of animals due to their aerodynamic manoeuvrability in water (Karbasiyan et al., 2016). Fig. 9(b) depicts the physical design of the sails for extracting energy from the water flow. The model consists of a series of sails that are connected and rotate in a rectangular motion. As the water flows through the device, the sails produce a lift force perpendicular to the water flow that is able to power the generator (Arkel et al., 2011).

According to Wang et al. (2020), a non-turbine system based on flow induced vibration (FIV) energy harvesting can be classified into four categories such as vortex-induced vibration (VIV), buffeting, galloping, and flutter. The VIVACE converter utilises VIV, galloping, and flow-induced motions (FIM) as shown in Fig. 9(c). The early model of the VIVACE converter was a combination of a physical spring, damper, and generator (Lee et al., 2011). The latest VIVACE is more complicated, with a cylinder, a belt, pulley transmission, a generator and controller to control the damping and spring forces. The flutter flag induces von Karman hydrodynamic instability and has a two-layer piezoelectric polymer PVDF with an electrode sandwiched in between, as shown in Fig. 9(d) (Pobering and Schwesinger, 2004). The differential pressure around the flag results in bending and will activate the charge separation inside the piezoelectric materials to produce the energy.

On the other hand, Yuce and Muratoglu (2015) classified existing hydrokinetic technology according to the principle of operation as shown in Fig. 10. Hydrokinetic systems are divided into current energy converter (CEC) systems and wave energy converter (WEC) systems. River current energy conversion systems (RECS), tidal-in stream energy converters (TISEC) and marine current turbines are placed under CEC. Oscillating water columns, overtopping devices, and wave activated bodies fall under WEC. Niebuhr et al. (2019) suggests that the classifications will be broadened since hydrokinetic energy technologies are continually emerging in numerous applications.

3. Survey on hydrokinetic technology

Hydrokinetic technology moved from the prototype stage to the pre-commercial stage as the technology started to emerge in 1990 (Lago et al., 2010; Zupone et al., 2015). Even though the hydrokinetic system is a relatively new technology, the maturity in WECS technologies will help it to develop rapidly due to the similarity in hardware components and operation. To the best of the authors' knowledge, at present no commercial marine hydrokinetic system is operational. Nevertheless, most of the manufacturers of marine hydrokinetic systems have tested prototypes, especially under the European Marine Energy Centre Ltd (EMEC). In contrast, river hydrokinetic systems are available in the market and have been installed in several remote community areas.

3.1. Hydrokinetic technology in tidal and marine settings





Hydrokinetic technology in tidal and marine settings has been emerging since the early 1990s. In early development, the underwater Electric Kite was developed by UEK Corporation in the United States with the diffuser augmented solid pontoon (Vauthier, 1988). The most significant success story of tidal energy comes from Marine Current Turbine Ltd (MCT). In the late 1990s, MCT started the Seaflo Project that was financed by the UK DTI, the European Commission and the German government. In 2003, the Seaflo, shown in Fig. 11(a), was installed and rotated for the first time with 300 kW output power. By November 2005, Seagen launched a twin-rotor turbine with capacity of more than 1000 kW output power, shown in Fig. 11(b) (Fraenkel, 2004). Currently, MCT is managed under the Atlantis turbine division after acquisition by Siemens in 2015 (Tidal Turbines, 2019).

Verdant Power (Fig. 11(c)) was the first company to acquire a commercial licence for a tidal power project in the United States. From 2006 to 2009, the company tested six full scale prototypes at the East River in New York City. Verdant Power has advanced the Kinetic Hydropower System (KHPS) to the 5th Generation (Gen5) based on operational experience gained from the Roosevelt Island Tidal Energy (RITE) project (Kinetic Hydropower System, 2017). Scotrenewables Tidal Power Limited launched SR250, a 250 kW prototype of a large floating tidal turbine in 2011. In 2016, the company successfully launched the 2 MW SR2000, shown in Fig. 11(d), which is the world's largest tidal energy converter (Scotrenewables Lmd, 2017). The company claims that the floating tidal turbine can sustain 20 years of operation in a harsh marine environment, in contrast to a bed-mounted system.

Open Hydro Canada was established in 2014 to commercialise tidal technology. Several projects have been carried out successfully, such as 4 MW tidal array at the Bay of Fundy, Nova Scotia, Canada, and 100 MW tidal farm at Antrim Coast, Northern Ireland in 2012. OpenHydro's design philosophy is to keep the turbine as simple as possible to reduce build and maintenance costs (OpenHydro, 2017). The RER Hydro TREK (Kinetic Energy Recovery Turbine) (Laws and Epps, 2016), which is shown in Fig. 11(e), is a ducted, multi-stage turbine. There are three rows of blades, in which the first and last rows acting as stators (Hanson, 2014). The TREK has been in full-scale testing since 2010. In 2012, RER Hydro partnered with Boeing, giving Boeing the rights to sell and market the RER hydro technology. The Nautricity Cormat, shown in Fig. 11(f), consists of two rows of contra-rotating blades and is moored by a single point at the front of the floating turbine. In this design, the turbine can align with the flow stream passively. The Cormat is currently in commercial-scale testing.

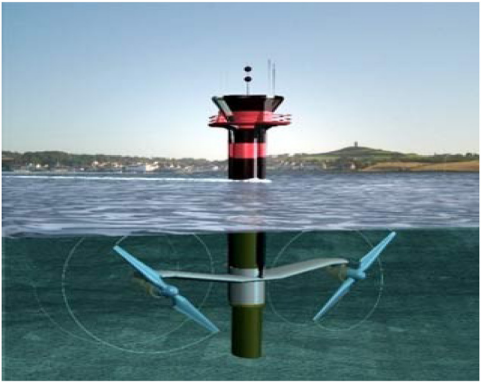
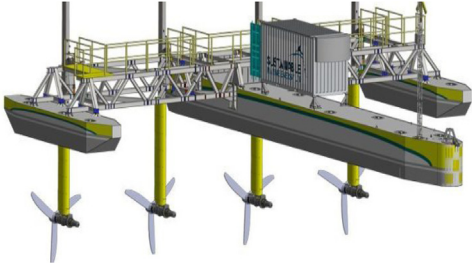

Table 1 lists recent manufacturer and pre-commercial testing projects, specifically those under The European Marine Energy Centre Ltd (EMEC).

Table 1
List of manufacturer and pre-commercial testing under EMEC.

Manufacturer	Devices	^a Turbine specification	Project	Requirements	Illustration
Verdant power (Free Flow System, 2019)	Gen5 Free Flow System (FFS) TRIFRAME-3 Gen5 FFS	3- Blades horizontal axis 5 m, > 1.8 ms ⁻¹ 35 kW	Roosevelt Island Tidal Energy (RITE)	Requires a rigid structure mounting to support the turbine at the seabed.	
Atlantis resources (Atlantis Resource Corp, 2019)	AR1500	3- Blades horizontal axis 18 m, 3.0 ms ⁻¹ 1500 kW	Meygen Project (2019)	Need to build a solid structure at the seabed to hold the turbine pillar.	
Andritz Hydro Hammerfest (MK1, 2019)	MK1	3- Blades horizontal axis 18–26 m, undisclosed 1000–1500 kW	Pentland Firth, Scotland	Placed at the seabed, requires a strong structure to support the turbine.	
Marine Current Turbine-Siemens (Siemens, 2019)	SeaGen	2-Blades horizontal axis 18 m 2.4 ms ⁻¹ 1200 kW	Kyle Rhea, Scotland Anglesey Skerries, Wales	Requires a piling at the seabed. High cost of construction.	
Orbital Marine Power Ltd. (SR2000, 2019)	SR-2000	2-Blades horizontal axis 16 m 3 ms ⁻¹ 2000 kW	Lashy Sound, Orkney	Requires a large floating platform to hold the turbine.	

(continued on next page)

Table 1 (continued).

Manufacturer	Devices	^a Turbine specification	Project	Requirements	Illustration
Sustainable Marine Energy (SME) (Plat-I, 2019)	Platform for Inshore Energy (PLAT-I)-SIT 250 (Hydro, 2018)	3- Blades horizontal axis 4–6.3 m 3.2–2.7 ms ⁻¹ 280 kW	Grand Passage, Nova Scotia	Required to build a floating platform to hold the array turbines.	
Tocado (2021)	T1	2-Blades horizontal axis -undisclosed 100 kW	Afsluitdijk, Netherlands (Power, 2019)	Only suitable to be deployed at the tide barrier, required to build a complete structure to hold the turbine.	

Note:

^aTurbine specifications sequences as follows; number of blades, types, diameter, water velocity, output power.

3.2. Hydrokinetic technology in rivers

The river energy conversion systems employ the same principle as the tidal systems, but with lower output power, and are suitable for remote communities. The systems are based on floating structures and are placed at river channels. Table 2 provides the specifications of the hydrokinetic river turbines available on the market.

Smart Hydro Power has developed two types of river turbines: the Smart Monofloat and the Smart Free Stream. Both turbines have debris protection with a 5 kW under-water generator. Smart Monofloat, as shown in Fig. 12(a), has a diffuser system to increase the velocity of the water. The Smart Free Stream, shown in Fig. 12(b), is very reliable and requires almost no maintenance. The turbine is installed on a river-bed or canal with the slightly curved blades to reduce debris effects.

The Waterotor in Fig. 12(c) can produce a high energy output while operating in shallow waters with low flow speeds (Waterotor Energy Technologies, 2017). The system can extract the energy at as slow as 2 mph flow consistently when submerged in rivers or canals. A rotating drum-like mechanism in the Waterotor generates mechanical power which is converted into electricity by on-board generators. The advantages of this invention are that it is possible to suspend the system from buoys or anchor it to the sea-floor. Moreover, the design requires no blades and is safe for aquatic life (Neil, 2017). The Idénergie, a novel form of sub-water electricity generator, is shown in Fig. 12(d). The system has high efficiency even at low water velocity. With the fully-sealed housing the generator is able to produce more than 500 W continuously, which converts to 12 kWh per day (River Turbine, 2018). Details of the design, energy conversion, and control method were not disclosed.

4. Research prospects in hydrokinetic technology

Apart from new designs, most of the recent research in the hydrokinetic field is focused on site assessment, turbine efficiency improvement, and environmental impacts. Site assessment is important to determine the energy capacity and to ensure that

a suitable location for energy harnessing is found. The turbine efficiency can be improved by a duct/shroud, augmentation and innovation in turbine design. On the other hand, studies related to non-turbine energy conversion schemes and river channel bathymetry constitute other tracks for research in the field. Furthermore, the MPPT and other control strategies are necessary to extract the maximum power and are also receiving attention.

4.1. Assessment studies



Several assessment and feasibility studies have investigated the potential for hydrokinetic energy harnessing from rivers. For example, the assessment of small and medium size rivers in Lithuania revealed that they are able to produce 79.4 GWh of electric energy per year (Sarauskiene, 2017). Initial assessment of river current energy in Canada indicated that the country has a huge potential of up to 340 GW of energy (Marine Renewables Canada, 2018; Jenkinson et al., 2014). Evaluation in Alaska indicated an available power in the range 1900–6500 W m⁻² (Kalnacs, 2017).

Several assessment studies have focused on tailwater and water spillway. For example, the feasibility studies in the tailwaters of Nigeria's hydropower station are able to produce from 228.7 MW to 342.4 MW with 10, 25 and 50 array turbines (Ladokun et al., 2018). In addition, feasibility studies on hydrokinetic turbines at the spillway of a barrage gate showed an expected production of 14.88 MW (Shafei M.A.R et al., 2015). Table 3 summarises the recent assessment studies investigating the potential of hydrokinetic systems.

4.2. Broader research on hydrokinetic turbines

Turbines with a diffuser and augmentation channel are still the focus for research in the field (Song et al., 2019; Vaz et al., 2019; Nunes et al., 2019). Augmentation channels can increase the velocity of the water; this can in turn provide greater energy extraction (Yuce and Muratoglu, 2015). The increase in pressure within the confined area in the augmentation channel leads to an increase in the velocity of the flow. If the turbine has been

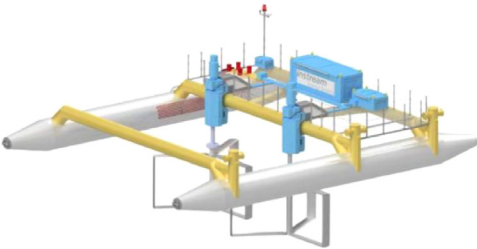
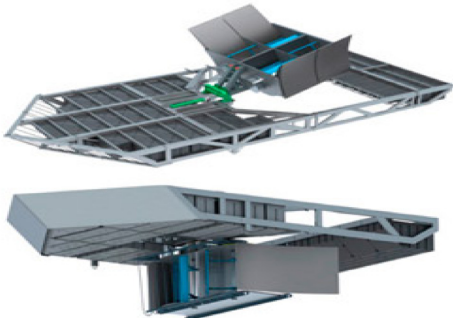
Table 2
List of companies and associated hydrokinetic technologies for river systems.

Manufacturers	Device name	Turbine specification	Requirements	Illustration
Instream Energy Systems Corp. (Canada)	Instream vertical axis hydrokinetic turbines	Vertical axis H-Darrieus Pout = 25 kW	Required a floating platform to support the structure.	
HydroQuest (France)	Hydroquest river 1.4	Twin vertical axis H-Darrieus Pout = up to 40 kW	Big in size and suitable for river with large cross-sectional.	
Ocean Renewable Power Company (USA)	RivGen power system	Cross-flow Pout = 35 kW	Required a large floating platform	
Guinard Energies (France)	P66 hydrokinetic turbine	Horizontal axis turbine Pout = 3.5 kW	Required a rigid structure to support the turbine	

(continued on next page)

placed on a channel, the velocity around the rotor will be higher than that of the free rotor.

Different terms are used widely to represent the augmentation channels, including ducts, shrouds, wind-lenses, nozzles, concentrators, or diffusers, all used synonymously (Khan et al., 2006). The Betz limit does not apply to turbines with augmentation channels. Nevertheless, this limit is dependent on the inlet–outlet pressure gradient as well as the volume of flow through the duct. This factor is dependent upon the duct’s shape and the duct-turbine area ratio (García et al., 2014). Fig. 12 shows the classification of various design augmentation channels. They can be categorised into two types, namely hybrid and diffuser type.

Fig. 13 shows the channel shape from a top and side view of augmentation channels. Hybrid type augmentation is suitable for vertical type turbines while the diffuser type is more suitable for horizontal axis turbines. Several groups have produced systematic reviews and analyses regarding diffuser-augmentation turbines. For example in Nunes et al. (2020), it is found that the tip speed ratio has an approximately 90% narrow operational interval by using the diffuser-augmentation on a horizontal-axis turbine. In Wong et al. (2017), the maximum output power increases dramatically using the vertical axis turbine augmentation system. In Bontempo and Manna (2020), a newly-developed axial momentum theory approach and an extended version of the free-wake ring-vortex actuator-disk model for a diffuser-augmented

Table 2 (continued).



Manufacturers	Device name	Turbine specification	Requirements	Illustration
New Energy Corp (Canada)	EnviroGen 005 series	Vertical axis H-Darrieus Pout = 5.0 kW	Required a floating platform to support the turbine	
Idenergies Inc (Canada)	Riverlution turbine	Cross-flow darrieus Pout = 500 W	Need to be deployed at the riverbed	
Smart Hydro Power (Germany)	Smart monofloat	Horizontal axis Pout 5.0 kW	Required a strong anchor point to support the structure	

Table 3
List of the recent assessment location studies.

Authors	Location	Methodology	Outcomes/comment	Issues
D'Auteuil et al. (2019)	Winnipeg River Canada	By Satellite Imagery from Digital Globes & Image Finder. Then compared to aerial photos.	Suitable for river assessment at cold climate regions.	Higher cost due to usage of aerial/drone.
Fouz et al. (2019)	Mino Estuary, (NW Spain & N Portugal)	Numerical model formulation through analysis of space-time distribution by Delft3D flow model.	Estimated to produce 2.26 MWh during Winter & Spring. Power drop up to 69% during summer & autumn.	Complicated due to numerical model formulation.
Hazim et al. (2019)	Morocco (Tarfaya, El-Jadida and Tangier)	3D Simulating Wave nearshore (SWAN).	Estimated to produce 2514 W m ⁻² at stream velocity >2.5 ms ⁻¹ .	Higher cost due to 3D software.
Santos et al. (2019)	Amazon river basin	Collecting bathymetric river data such as sectional area, depth & velocity.	Estimated to produce 109.5 kW and 31.5 kW at the Jamari and Curua Ana river respectively.	Non-competitive because LCOE is still high (\$80–\$123 /MWh).

Table 4
List of recent turbine developments and improvements in hydrokinetic research.

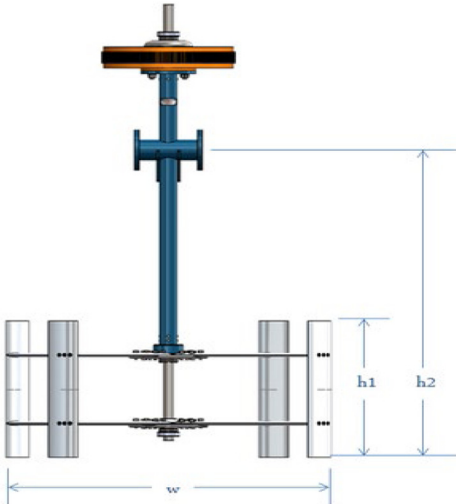
Authors	Research topic	Notes/comment/issues	Illustration
Mosbahi et al. (2019)	A new deflector system design for three blade Helical Savonius turbine.	<ul style="list-style-type: none"> • A new deflector system design for three blade Helical Savonius hydrokinetic turbine to improve the power coefficient from 0.125 to 0.14 at 0.7 TSR. • Six configurations of the deflector system have been studied using CFD in Ansys Fluent 17 to determine the optimal configuration. • Increases the cost of the turbine. 	
Patel et al. (2019)	Effect on different geometries of channel on Savonius turbine	<ul style="list-style-type: none"> • Investigated the effect of hump at the bottom of channel and channel sidewall location on the Savonius turbine. • The effect of hump will increase the output power up to 83%. • High cost, requires the study and imaging of riverbed. 	<p>(1) Channel (2) Hump (3) Turbine rotor (4) Load pan (5) Spring balance</p>
Abutunis et al. (2019)	Blade Element Momentum (BEM) improvement for horizontal axis hydrokinetic turbine	<ul style="list-style-type: none"> • Proposed the multilayer perceptron Neural Network (MLP-NN) algorithm for blade element momentum (BEM) to overcome convergence issues and improve the turbine structure. 	

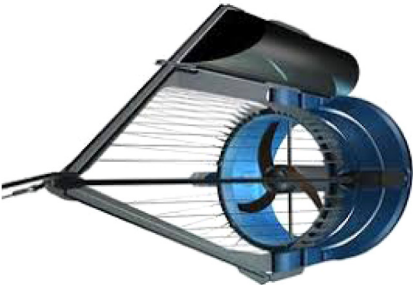
(continued on next page)

Table 4 (continued).

Authors	Research topic	Notes/comment/issues	Illustration
Vaz et al. (2019)	Assessment of the wind and hydrokinetic turbine with a diffuser	<ul style="list-style-type: none"> • Complicated programming and requires training. • Investigated the effect of diffuser on the powertrain resistance, dissipative torque and starting torque. • The finding is the use of diffuser will increase the dissipative torque of the turbine powertrain. • The diffuser turbine has a 27% lower starting torque compared to a bare turbine. 	
Song et al. (2019)	Analysis of a diffuser-augmented turbine	<ul style="list-style-type: none"> • Investigated the Micro horizontal axis diffuser turbine (MHDT) through CFD and experiment. • The C_p is increased up to 45% with the diffuser compared to the bare turbine. • High cost of design due to double buoyancy tube. 	
Nunes et al. (2019)	Diffuser enhanced propeller	<ul style="list-style-type: none"> • Evaluates two geometries of rear diffuser for 4-blades horizontal axis turbines. • The turbine's power coefficient is improved between 48% and 79%. • High cost and reliability problems. 	

wind turbine is proposed. The proposed diffuser-augmentation is based on a divided duct surface, into an internal and external part (see Fig. 14).

On the other hand, wake studies also constitute a research trend in hydrokinetic systems. For example, Lust et al. (2020) presented a survey of the near wake of the horizontal axis in the presence of surface gravity waves. Dou et al. (2019) proposed a wake model to predict the turbine wake in a yawed condition. The wake measurement data from Guerra and Thomson (2019) can be used for numerical validation and hydrokinetic turbine

array design. The interaction between the turbine wakes and sediment has also been investigated in Musa et al. (2019). A summary of recent developments and advances in hydrokinetic research is shown in Table 4.

4.3. Other research trends in hydrokinetic systems

Hydrokinetic research is not limited to assessment studies and turbine improvement but also extends to non-turbine energy conversion and environmental studies. Several groups have

Table 5
Various research trend in the hydrokinetic system.

Authors	Research topic	Notes/comment/issues	Illustration
Arias and De Las Heras (2019)	Oscillating membrane based for hydrokinetic energy extraction.	<ul style="list-style-type: none"> Proposed a novel design of an oscillating-membrane induced by a water flow. Designed to harness the energy from narrow channels, i.e. a place not suitable for using a turbine. Able to generate 30 mW cm^{-2} at 2.0 m s^{-1} water velocity. Very small output power. 	
Sun and Bernitsas (2019)	Bio-inspired adaptive damping for non-turbine hydrokinetic cylinder-oscillator which is an application based Flow-induced oscillation of Flow Induced Oscillation (FIO).	<ul style="list-style-type: none"> Studied the one-degree-of-freedom cylinder-oscillator which is an application based Flow-induced oscillation of Flow Induced Oscillation (FIO). Proposed a non-linear adaptive damping and linear spring stiffness for Vortex induced vibration (VIV) application. Requires a complicated mechanism and structure. 	

(continued on next page)

investigated different concepts for non-turbine energy conversion systems in hydrokinetic technologies, such as using a membrane (Arias and De Las Heras, 2019), a flapping foil (Duarte et al., 2019) and two tandem flapping hydrofoils (Ding et al., 2019). Different channel geometries at the bottom of the channel and channel sidewall have been investigated by Patel et al. (2019). Musa et al. (2019) investigated river channel bathymetry and sediment effect on the siting placement of the hydrokinetic turbine. Furthermore, Kirke (2019) studied the deployment of hydrokinetic turbines in rivers and concluded that the cost per kW of the technology is too high. In contrast, the LCOE of hydrokinetic power generation in the remote communities area at the Amazon River basin is up to USD125/MWh (Santos et al., 2019). Table 5 shows a summary of these and other research efforts.

On the other hand, several researchers have studied the effects of hydrokinetic technologies on ecological systems (Musa et al., 2019; Shields et al., 2011; Bonar and Bryden, 2015; Saini and Saini, 2020; Khaled et al., 2021; Hill, 2015). In Shields et al. (2011) and Bonar and Bryden (2015) a detailed discussion regarding the ecological impacts of marine energy extraction are presented. As noted in Saini and Saini (2020), almost 20% of bed level rises due to hydrokinetic turbine deployment. The interaction between sediment transport and the hydrokinetic turbine is investigated in Khaled et al. (2021) and Hill (2015). This study indicates that the asymmetric turbine installation might introduce bed topography deformation and change the bedform migration velocities. Furthermore, the effect of hydrokinetic turbines on fish has been investigated. Romero-Gomez and Richmond (2014) have reported that fish survival rates on hydrokinetic systems due to

Table 5 (continued).

Authors	Research topic	Notes/comment/issues	Illustration
Duarte et al. (2019)	Flapping foil hydrokinetic turbine.	<ul style="list-style-type: none"> • A fully passive flapping foils prototype has been designed and investigated based on Reynolds number of 6×10^4. • To identify the condition on the pitching axis location (l_θ) and pitching stiffness (K_θ). • Complicated to determine the best angle 	
Xu et al. (2019)	Tandem flapping hydrofoils.	<ul style="list-style-type: none"> • Design, built and tested the two flapping in-tandem configuration. • Two flapping tandems improve the efficiency to 36.6%. • The Tandem flapping is quite in operation, has less impact on the environment, and is suitable for a shallow water depth and low water speed. • Requires a complex mechanism and structure. 	
Ding et al. (2019)	Interactive two tandem cylinder for hydrokinetic	<ul style="list-style-type: none"> • Investigated two rough, tandem cylinders on spring of flow induce oscillation (FIO) at Reynolds number $30\,000 \leq Re \leq 120\,000$. • The results are validated with experimental data in LTFWSW channel and comparison how two tandem-cylinder will improve the efficiency. • The efficiency can improved up to 63% and 54% for spacing ratio, $d/D = 2.0$ and $d/D = 2.57$ respectively. • High cost, required twin tandem. 	

(continued on next page)

Table 5 (continued).

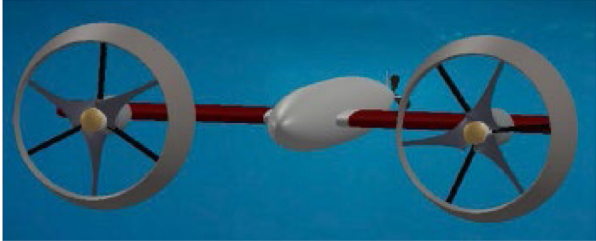
Authors	Research topic	Notes/comment/issues	Illustration
Tandon et al. (2019)	Mobile underwater turbine system	<ul style="list-style-type: none"> Proposed a novel hybrid of Autonomous Underwater Vehicles (AUV) and Hydrokinetic turbine. A solution to harness the energy at the Gulf stream due to meandering stream. High cost and complex design 	

blade-strike are higher than 96%, and higher than conventional hydropower. Additionally, Schramm et al. (2017) reported that the behaviour of fish was not altered due to the sound emissions of turbines.

5. Conclusions

This review outlines and discusses the recent status of hydrokinetic systems in marine and river applications. The relevant literature, such as turbine classification, turbine improvement, assessment studies, and research prospects and trends have been analysed to identify the barriers to commercialisation and the research gaps in the literature. Hydrokinetic systems do not depend on weather conditions and have low initial capital cost compared to hydropower, solar PV, WECS, and others RE. Therefore, hydrokinetic systems are one of the best options for clean energy for remote community areas and small-scale needs.

Judging from the literature, hydrokinetic systems can be classified under turbine and non-turbine systems. This review indicates that energy conversion through the turbine system has dominated research and development of the technology worldwide. The vertical axis turbine is preferable for river applications due to its small capacity, practicality, and cost-saving. Nevertheless, the non-turbine system is still a new research concept that requires further studies to test its reliability and practically for energy harnessing. On the other hand, a company and manufacturer survey indicated a great deal of pre-commercial testing and deployment of hydrokinetic prototypes under EMEC. A number of hydrokinetic products in river settings are already available on the market, for example the smart monofloat and smart free stream. Most of the recent research is aimed at improving the energy conversion of hydrokinetic technologies. This review attempts to raise awareness and interest amongst the research community to stimulate further exploration of HECS technologies, especially with regards to assessment studies and turbine improvements.

Declaration of competing interest

The authors declare that they have no known competing financial interests or personal relationships that could have appeared to influence the work reported in this paper.

Acknowledgements

This project was partially supported by the National Key Research and Development Program of China (Grant No. 2017YFB0701700). This project is supported by Ministry of Education Malaysia under the grant RDU150123/Fundamental Research Grant Scheme (FRGS) - MOHE and PGRS190318 - University Malaysia Pahang (UMP) Postgraduate Research Scheme. (PGRS). Mr. Ibrahim is working under Skim Latihan Akademik Bumiputra (SLAB)/Skim Latihan Akademik IPTA (SLAI) Ministry of Education Malaysia.

References

- Abutunis, A., Hussein, R., Chandrashekhara, K., 2019. A neural network approach to enhance blade element momentum theory performance for horizontal axis hydrokinetic turbine application. *Renew. Energy* 136, 1281–1293.
- Alvarez Alvarez, E., Rico-Secades, M., Corominas, E.L., Huerta-Medina, N., Soler Guitart, J., 2018. Design and control strategies for a modular hydrokinetic smart grid. *Int. J. Electr. Power Energy Syst.* 95, 137–145.
- Andrade Furtado, G.C.de, Amarante Mesquita, A.L., Morabito, A., Hendrick, P., Hunt, J.D., 2020. Using hydropower waterway locks for energy storage and renewable energies integration. *Appl. Energy* 275, 1–11.
- Anyi, M., Kirke, B., 2010. Evaluation of small axial flow hydrokinetic turbines for remote communities. *Energy Sustain. Dev.* 14, 110–116.
- Arias, F.J., De Las Heras, S., 2019. The extractable hydrokinetic power from an oscillating membrane-based harvester. *Theor. Appl. Mech. Lett.* 9, 66–70.
- Arkel, R.van, Owen, L., Allison, S., Tryfonas, T., Winter, A., Entwistle, R., et al., 2011. Design and preliminary testing of a novel concept low depth hydropower device. In: *Ocean. MTS/IEEE KONA*. pp. 1–10. <http://dx.doi.org/10.23919/OCEANS.2011.6107051>.
- Atlantis Resource Corp, 2019. AR1500 tidal turbine. pp. 1–6, www.atlantisresourcesltd.com (accessed July 18, 2019).
- Bachant, P., Wosnik, M., 2015. Performance measurements of cylindrical- and spherical-helical cross-flow marine hydrokinetic turbines, with estimates of exergy efficiency. *Renew. Energy* 74, 318–325.
- Bahaj, A.S., Myers, L.E., 2003. Fundamentals applicable to the utilisation of marine current turbines for energy production. *Renew. Energy* 28, 2205–2211.
- Barber, D., 2019. The four forces that influence wind speed & wind direction 2018. <https://sciencing.com/hadley-cell-effects-8550966.html> (accessed August 3, 2019).
- Behrouzi, F., Nakisa, M., Maimun, A., Ahmed, Y.M., 2016. Global renewable energy and its potential in Malaysia: A review of hydrokinetic turbine technology. *Renew. Sustain. Energy Rev.* 62, 1270–1281.
- Birjandi, A.H., Woods, J., Bibeau, E.L., 2012. Investigation of macro-turbulent flow structures interaction with a vertical hydrokinetic river turbine. *Renew. Energy* 48, 183–192.
- Bonar, P.A.J., Bryden, A.G.L., 2015. Social and ecological impacts of marine energy development. *Renew. Sustain. Energy Rev.* 47, 486–495. <http://dx.doi.org/10.1016/j.rser.2015.03.068>.
- Bontempo, R., Manna, M., 2020. On the potential of the ideal diffuser augmented wind turbine: an investigation by means of a momentum theory approach and of a free-wake ring-vortex actuator disk model. *Energy Convers. Manage.* 213, 112794. <http://dx.doi.org/10.1016/j.enconman.2020.112794>.
- Camera, F.La, 2019. People, planet and prosperity. Raising climate ambitions through renewables. *Int. Renew. Energy Agency* 1–24, <https://www.irena.org/publications/2019/Jul/People-Planet-and-Prosperity> (accessed August 20, 2019).
- Cavagnaro, R.J., 2016. Performance Evaluation, Emulation, and Control of Cross-Flow Hydrokinetic Turbines. University of Washington.
- D'Auteuil, S., Birjandi, A., Bibeau, E., Jordan, S., Soviak, J., Friesen, D., 2019. Riverine hydrokinetic resource assessment using low cost winter imagery. *Renew. Sustain. Energy Rev.* 105, 293–300.
- Davis, B., 1989. Vertical axis hydro turbines for off grid installations. In: *Int. Conf. Hydropower Niagara Falls*. New York, United States.
- Ding, W., Sun, H., Xu, W., Bernitsas, M.M., 2019. Numerical investigation on interactive FIO of two-tandem cylinders for hydrokinetic energy harnessing. *Ocean Eng.* 187.
- Dou, B., Guala, M., Lei, L., Zeng, P., 2019. Wake model for horizontal-axis wind and hydrokinetic turbines in yawed conditions. *Appl. Energy* 242, 1383–1395.
- Duarte, L., Dellinger, N., Dellinger, G., Ghenaïm, A., Terfous, A., 2019. Experimental investigation of the dynamic behaviour of a fully passive flapping foil hydrokinetic turbine. *J. Fluids Struct.* 88, 1–12.

- Elbatran, A.H., Yaakob, O.B., Ahmed, Y.M., Jalal, M.R., 2015. Novel approach of bidirectional diffuser-augmented channels system for enhancing hydrokinetic power generation in channels. *Renew. Energy* 83, 809–819.
- Forbush, D., Cavagnaro, R.J., Donegan, J., McEntee, J., Polagye, B., 2017. Multi-mode evaluation of power-maximizing cross-flow turbine controllers. *Int. J. Mar. Energy* 20, 80–96.
- Fouz, D.M., Carballo, R., Ramos, V., Iglesias, G., 2019. Hydrokinetic energy exploitation under combined river and tidal flow. *Renew. Energy* 143, 558–568.
- Fraenkel, P., 2004. Marine current turbines: An emerging technology. In: *Pap. Scottish Hydraul. Study Gr. Semin. Glas.* 19 March 2004 *Renew. Energy – Hydraul. Appl. – Theory Pract.* pp. 1–10.
2019. Free Flow System. Verdant Power Inc, <https://www.verdantpower.com/free-flow-system> (accessed July 22, 2019).
- García, E., Pizá, R., Benavides, X., Quiles, E., Correcher, A., Morant, F., 2014. Mechanical augmentation channel design for turbine current generators. *Adv. Mech. Eng.* 2014.
- Gholikhani, M., Roshani, H., Dessouky, S., Papagiannakis, A.T., 2020. A critical review of roadway energy harvesting technologies. *Appl. Energy* 261, 1–17.
- Ginter, V.J., Pieper, J.K., 2011. Robust gain scheduled control of a hydrokinetic turbine. *IEEE Trans. Control Syst. Technol.* 19, 805–817.
- Guerra, M., Thomson, J., 2019. Wake measurements from a hydrokinetic river turbine. *Renew. Energy* 139, 483–495.
- Güney, M.S., Kaygusuz, K., 2010. Hydrokinetic energy conversion systems: A technology status review. *Renew. Sustain. Energy Rev.* 14, 2996–3004.
- Hamta, A., Birjandi, A.H., Bibeau, E.L., 2013. Influence of turbulent flow field on power generation. In: 2013 IEEE Ocean. – San Diego. pp. 1–6.
- Hanson, K., 2014. RER Hydro. Shop Metalwork Technol, <https://shopmetaltech.com/fabricating-technology/fabricating/river-trek.html> (accessed November 23, 2019).
- Hazim, S., El Ouatouati, A., Janan, M.T., Ghennioui, A., 2019. Marine currents energy resource characterization for Morocco. In: *Technol. Mater. Renew. Energy, Environ. Sustain. TMRES18*, Vol. 157. Energy Procedia, Athens, Greece, pp. 1037–1049.
- Hill, C.S., 2015. Interactions Between Channel Topography and Hydrokinetic Turbines : Sediment Transport, Turbine Performance, and Wake Characteristics. The University of Minnesota.
- Hydro, S., 2018. Plat-1, accessible tidal energy for island and coastal communities.
- IEA, 2018. World Energy Outlook 2018: The Future Is Electrifying. Int Energy Agency, <https://www.iea.org/workshops/world-energy-outlook-2018-the-future-is-electrifying.html> (accessed August 10, 2019).
- Izadyar, N., Ong, H.C., Chong, W.T., Mojumder, J.C., Leong, K.Y., 2016. Investigation of potential hybrid renewable energy at various rural areas in Malaysia. *J. Clean. Prod.* 139, 61–73.
- Jenkinson, W., Klyszejko, E., Nadeau, M., 2014. Assessment of Canada's river hydrokinetic power potential. In: *Int. Conf. Ocean Energy*. Halifax, NS Canada, pp. 1–17.
- Kadier, A., Sahaid, M., Pudukudy, M., Abu, H., Mohamed, A., Abdul, A., 2018. Pico hydropower (PHP) development in Malaysia : Potential, present status, barriers and future perspectives. *Renew. Sustain. Energy Rev.* 81, 2796–2805.
- Kalnacs, A., 2017. Energy Potential Assessment and Efficiency Improvement of in-Stream Hydrokinetic Devices. Riga Technical University.
- Karbasian, H.R., Esfahani, J.A., Barati, E., 2016. The power extraction by flapping foil hydrokinetic turbine in swing arm mode. *Renew. Energy* 88, 130–142.
- Karin, J., 2019. Hydropower from vortex induced vibrations. *Futur Things* <https://thefutureofthings.com/3889-hydropower-from-vortex-induced-vibrations/> (accessed August 19, 2019).
- Khaled, F., Hadri, F., Guillou, S., 2021. Impact of the blockage ratio on the transport of sediment in the presence of a hydrokinetic turbine : Numerical modeling of the interaction sediment and turbine. *Int. J. Sediment Res.* 1–16. <http://dx.doi.org/10.1016/j.ijsrc.2021.02.003>.
- Khalid, S.S., Liang, Z., Shah, N., 2013. Harnessing tidal energy using vertical axis tidal turbine. *Res. J. Appl. Sci. Eng. Technol.* 5, 239–252.
- Khan, M.J., Bhuyan, G., Iqbal, M.T., Quaicoe, J.E., 2009. Hydrokinetic energy conversion systems and assessment of horizontal and vertical axis turbines for river and tidal applications: A technology status review. *Appl. Energy* 86, 1823–1835.
- Khan, M.J.K.M.J., Iqbal, M.T.I.M.T., Quaicoe, J.E.Q.J.E., 2006. A technology review and simulation based performance analysis of river current turbine systems. In: 2006 Can. Conf. Electr. Comput. Eng.. pp. 2288–2293.
- Khan, M.J., Iqbal, M.T., Quaicoe, J.E., 2008. River current energy conversion systems: Progress, prospects and challenges. *Renew. Sustain. Energy Rev.* 12, 2177–2193.
2017. Kinetic hydropower system (KHPS) verdant power 2017. <http://www.verdantpower.com/kinetic-hydropower-system.html> (accessed November 11, 2017).
- Kirke, B., 2019. Hydrokinetic and ultra-low head turbines in rivers: A reality check. *Energy Sustain. Dev.* 52, 1–10.
- Koko, S.P., Kusakana, K., Vermaak, H.J., 2015. Micro-hydrokinetic river system modelling and analysis as compared to wind system for remote rural electrification. *Electr. Power Syst. Res.* 126, 38–44.
- Kumar, D., Chatterjee, K., 2016. A review of conventional and advanced MPPT algorithms for wind energy systems. *Renew. Sustain. Energy Rev.* 55, 957–970.
- Kumar, D., Sarkar, S., 2016. A review on the technology, performance, design optimization, reliability, techno-economics and environmental impacts of hydrokinetic energy conversion systems. *Renew. Sustain. Energy Rev.* 58, 796–813.
- Ladokun, L.L., Sule, B.F., Ajao, K.R., Adeogun, A.G., 2018. Resource assessment and feasibility study for the generation of hydrokinetic power in the tailwaters of selected hydropower stations in Nigeria. *Water Sci.*
- Lago, L.I., Ponta, F.L., Chen, L., 2010. Advances and trends in hydrokinetic turbine systems. *Energy Sustain. Dev.* 14, 287–296.
- Laws, N.D., Epps, B.P., 2016. Hydrokinetic energy conversion: Technology, research, and outlook. *Renew. Sustain. Energy Rev.* 57, 1245–1259.
- Lee, J.H., Xiros, N., Bernitsas, M.M., 2011. Virtual damperspring system for VIV experiments and hydrokinetic energy conversion. *Ocean Eng.* 38, 732–747.
- Levy, D., 1995. Power from natural flow at zero static head. *Int. Power Gener.* 18.
- Li, J., Chen, S., Wu, Y., Wang, Q., Liu, X., Qi, L., et al., 2021. How to make better use of intermittent and variable energy? A review of wind and photovoltaic power consumption in China. *Renew. Sustain. Energy Rev.* 137, 110626. <http://dx.doi.org/10.1016/j.rser.2020.110626>.
- Loots, I., Van Dijk, M., Barta, B., Van Vuuren, S.J., Bhagwan, J.N., 2015. A review of low head hydropower technologies and applications in a South African context. *Renew. Sustain. Energy Rev.* 50, 1254–1268. <http://dx.doi.org/10.1016/j.rser.2015.05.064>.
- Lust, E.E., Flack, K.A., Luznik, L., 2020. Survey of the near wake of an axial-flow hydrokinetic turbine in the presence of waves. *Renew. Energy* 129, 92–101.
- Magagna, D., Uihlein, A., 2015. Ocean energy development in europe: Current status and future perspectives. *Int. J. Mar. Energy* 11, 84–104. <http://dx.doi.org/10.1016/j.ijome.2015.05.001>.
2018. Marine Renewables Canada. 2018 State of the Sector Report. Canada.
- Meygen Project, 2019. Simec atl energy 2019. <https://simecatlantia.com/projects/meygen/> (accessed July 22, 2019).
- Mishra, M.K., Khare, N., Agrawal, A.B., 2015. Small hydro power in India: Current status and future perspectives. *Renew. Sustain. Energy Rev.* 51, 101–115.
- MK1, 2019. Andritz hydro hammerfest 2019. <http://www.andritzhydrohammerfest.co.uk/references/> (accessed July 22, 2019).
- Mosbahi, M., Ayadi, A., Chouaibi, Y., Driss, Z., Tucciarelli, T., 2019. Performance study of a helical savonius hydrokinetic turbine with a new deflector system design. *Energy Convers. Manage.* 194, 55–74.
- Muljadi, E., Wright, A., Donegan, J., Marnagh, C., Muljadi, E., Wright, A., 2016. Power generation for river and tidal generators power generation for river and tidal generators. *Natl. Renew. Energy Lab.* 1–55.
- Musa, M., Hill, C., Guala, M., 2019. Interaction between hydrokinetic turbine wakes and sediment dynamics: array performance and geomorphic effects under different siting strategies and sediment transport conditions. *Renew. Energy* 138, 738–753.
- Neil, S., 2017. Could sea-current generator be used here? 22 July 2015. <http://www.royalgazette.com/article/20150722/BUSINESS/150729918> (accessed March 21, 2017).
- Neill, S.P., Hashemi, M.R., 2018. Chapter 3 - tidal energy. In: Neill, S.P., Hashemi M.R.B.T.-F. of ORE (Eds.), *E-Bus. Solut.*. Academic Press, pp. 47–81. <http://dx.doi.org/10.1016/B978-0-12-810448-4.00003-3>.
- Niebuhr, C.M., van Dijk, M., Neary, V.S., Bhagwan, J.N., 2019. A review of hydrokinetic turbines and enhancement techniques for canal installations: Technology, applicability and potential. *Renew. Sustain. Energy Rev.* 113.
- Nishi, Y., Suzuo, R., Sukemori, D., Inagaki, T., 2020. Loss analysis of gravitation vortex type water turbine and influence of flow rate on the turbine's performance. *Renew. Energy* 155, 1103–1117. <http://dx.doi.org/10.1016/j.renene.2020.03.186>.
- Nunes, M.M., Brasil Junior, A.C.P., Oliveira, T.F., 2020. Brasil junior a.c.p oliveira t.f systematic review of diffuser-augmented horizontal-axis turbines. *Renew. Sustain. Energy Rev.* 133, 110075. <http://dx.doi.org/10.1016/j.rser.2020.110075>.
- Nunes, M.M., Mendes, R.C.F., Oliveira, T.F., Brasil Junior, A.C.P., 2019. An experimental study on the diffuser-enhanced propeller hydrokinetic turbines. *Renew. Energy* 133, 840–848.
- OpenHydro, 2017. Openhydro naval energies 2017. <http://www.openhydro.com/Company/Overview> (accessed November 11, 2017).
- ORPC, 2019. Utility Grid. ORPC, Inc, <http://www.orpc.com/markets/utility-grids> (accessed August 13, 2019).
- Patel, V., Eldho, T.L., Prabhu, S.V., 2019. Velocity and performance correction methodology for hydrokinetic turbines experimented with different geometry of the channel. *Renew. Energy* 131, 1300–1317.
- Peter Garman, 1986. *Water Current Turbines: A Fieldworker's Guide*. Intermed Technol Publ.

- Petrie, J., Diplas, P., Gutierrez, M., Nam, S., 2014. Characterizing the mean flow field in rivers for resource and environmental impact assessments of hydrokinetic energy generation sites. *Renew. Energy* 69, 393–401.
- Plat-I, 2019. Sustain mar energy 2019. <https://sustainablemarine.com/news/plat-i-testing-1> (accessed July 22, 2019).
- Pobering, S., Schwesinger, N., 2004. A novel hydropower harvesting device. In: 2004 IEEE Int. Conf. MEMS, NANO Smart Syst., Banff, AB, Canada, pp. 480–485.
- Power, T., 2019. Tidal Power Plant Afsluitdijk Netherlands. Tocado Tidal Power 2016. <https://www.tocado.com/wp-content/uploads/2016/06/Afsluitdijk-Tidal-Power-Plant.pdf> (accessed July 24, 2019).
- R, R.L., H, B.D., 1981. Definition of Cost Effective River Turbine Designs. US Dep Energy, <https://www.osti.gov/biblio/5358098> (accessed November 27, 2019).
2018. River Turbine. Idenergie Inc. <http://idenergie.ca/en/river-turbine/> (accessed February 11, 2018).
- Romero-Gomez, P., Richmond, M.C., 2014. Simulating blade-strike on fish passing through marine hydrokinetic turbines. *Renew. Energy* 71, 401–413.
- Saini, G., Saini, R.P., 2019. A review on technology, configurations, and performance of cross-flow hydrokinetic turbines. *Int. J. Energy Res.* 43, 6639–6679. <http://dx.doi.org/10.1002/er.4625>.
- Saini, G., Saini, R.P., 2020. Study of installations of hydrokinetic turbines and their environmental effects. In: AIP Conf Proc. p. 2273. <http://dx.doi.org/10.1063/5.0024338>.
- Salter, S., 2005. Pitch-control for vertical-axis, marine-current generator. In: *World Renew. Energy Conf. Aberdeen 2005*. pp. 1–6.
- Santos, I.F.S.dos, Camacho, R.G.R., Tiago Filho, G.L., Botan, A.C.B., Vinent, B.A., 2019. Energy potential and economic analysis of hydrokinetic turbines implementation in rivers: An approach using numerical predictions (CFD) and experimental data. *Renew. Energy* 143, 648–662.
- Sarauškiene, D., 2017. Assessment of hydrokinetic resources of small and medium-size rivers : The Lithuanian case. *Baltica* 30, 23–30.
- Sarma, N.K., Biswas, A., Misra, R.D., 2014. Experimental and computational evaluation of savonius hydrokinetic turbine for low velocity condition with comparison to savonius wind turbine at the same input power. *Energy Convers. Manage.* 83, 88–98.
- Scarlat, N., Dallem, J.-F., 2018. Future role of bioenergy. In: *Role Bioenergy Bioeconomy*. pp. 435–547.
- Schramm, M.P., Bevelhimer, M., Scherelis, C., 2017. Effects of hydrokinetic turbine sound on the behavior of four species of fish within an experimental mesocosm. *Fish Res.* 190, 1–14.
- Scotrenewables Lmd, 2017. Scotrenewables tidal power limited 2017. <http://www.scotrenewables.com/technology-development/sr2000> (accessed November 11, 2017).
- Shafei M.A.R, D.K., Ali, A.M., Younes, M.A.A., El-Zahab, E.E.D.A., 2015. Novel approach for hydrokinetic turbine applications. *Energy Sustain. Dev.* 27, 120–126.
- Shahsavari, M., Bibeau, E.L., Chatoorgoon, V., 2015. Effect of shroud on the performance of horizontal axis hydrokinetic turbines. *Ocean Eng.* 96, 215–225.
- Shields, M.A., Woolf, D.K., Grist, E.P.M., Kerr, S.A., Jackson, A.C., Harris, R.E., et al., 2011. Marine renewable energy: The ecological implications of altering the hydrodynamics of the marine environment. *Ocean Coast. Manage.* 54, 2–9. <http://dx.doi.org/10.1016/j.ocecoaman.2010.10.036>.
- Siemens, 2019. World-Leading Tidal Energy System Achieves 5GWh Milestone. Siemens Inc, http://www.siemens.co.uk/en/news_press/index/news_archive/seagen-achieves-5gw-tidal-power-generation-milestone.htm (accessed July 22, 2019).
- Song, K., Wang, W.Q., Yan, Y., 2019. Numerical and experimental analysis of a diffuser-augmented micro-hydro turbine. *Ocean Eng.* 171, 590–602.
- Sornes, K., 2010. Small-scale water current turbines for river applications.
- Sovacool, B.K., Bulan, L.C., 2012. Energy security and hydropower development in Malaysia : The drivers and challenges facing the Sarawak Corridor of Renewable Energy (SCORE). *Renew. Energy* 40, 113–129.
- SR2000, SR2000, 2019. Orbital mar power 2019. <https://orbitalmarine.com/technology-development/sr2000> (accessed July 22, 2019).
- Sun, H., Bernitsas, M.M., 2019. Bio-inspired adaptive damping in hydrokinetic energy harnessing using flow-induced oscillations. *Energy* 176, 940–960.
- Tandon, S., Divi, S., Muglia, M., Vermillion, C., Mazzoleni, A., 2019. Modeling and dynamic analysis of a mobile underwater turbine system for harvesting marine hydrokinetic energy. *Ocean Eng.* 187, 106069.
- Tanier-Gesner, F., Stillinger, C., Bond, A., Egan, P., Perry, J., 2014. Design, build and testing of a hydrokinetic H-Darrieus turbine for developing countries. In: *IEEE Power Energy Soc. Gen. Meet. Vol. 2014, National Harbour, Washington DC*, pp. 1–5.
- Tidal Turbines, 2019. Simec atl energy 2019. <https://simecatlantia.com/services/turbines/> (accessed July 23, 2019).
- TidGen Power Generation, 2019. Ocean renew power energy 2017. http://www.orpc.co/orpcpowersystem_tidgenpowersystem.aspx (accessed July 23, 2019).
- Tocado: The Dutch Tidal Power Company, <https://www.tocado.com/about/> (accessed 23 March 2021).
- Vauthier, P., 1988. The underwater electric kite east river deployment. In: *Ocean. '88. A Partnersh. Mar. Interes. Proc. Vol. 3, Baltimore, Maryland*, pp. 1029–1033.
- Vaz, J.R.P., Mesquita, A.L.A., Amarante Mesquita, A.L., Oliveira, T.F.de, Brasil Junior, A.C.P., 2019. Powertrain assessment of wind and hydrokinetic turbines with diffusers. *Energy Convers. Manage.* 195, 1012–1021.
- Vennell, R., Funke, S.W., Draper, S., Stevens, C., Divett, T., 2015. Designing large arrays of tidal turbines: A synthesis and review. *Renew. Sustain. Energy Rev.* 41, 454–472.
- Vermaak, H.J., Kusakana, K., Koko, S.P., 2014. Status of micro-hydrokinetic river technology in rural applications: A review of literature. *Renew. Sustain. Energy Rev.* 29, 625–633.
- Wang, J., Geng, L., Ding, L., Zhu, H., Yurchenko, D., 2020. The state-of-the-art review on energy harvesting from flow-induced vibrations. *Appl. Energy* 267, 114902. <http://dx.doi.org/10.1016/j.apenergy.2020.114902>.
2017. Waterrotor energy technologies 2017. <http://waterrotor.com/> (accessed March 21, 2017).
- Wong, K.H., Chong, W.T., Sukiman, N.L., Poh, S.C., Shiah, Y.C., Wang, C.T., 2017. Performance enhancements on vertical axis wind turbines using flow augmentation systems: A review. *Renew. Sustain. Energy Rev.* 73, 904–921. <http://dx.doi.org/10.1016/j.rser.2017.01.160>.
- Xu, W., Xu, G., Duan, W., Song, Z., Lei, J., 2019. Experimental and numerical study of a hydrokinetic turbine based on tandem flapping hydrofoils. *Energy* 174, 375–385.
- Yao, Y., Xu, J.H., Sun, D.Q., 2021. Untangling global levelised cost of electricity based on multi-factor learning curve for renewable energy: Wind, solar, geothermal, hydropower and bioenergy. *J. Clean. Prod.* 285, 124827. <http://dx.doi.org/10.1016/j.jclepro.2020.124827>.
- Yuce, M.I., Muratoglu, A., 2015. Hydrokinetic energy conversion systems: A technology status review. *Renew. Sustain. Energy Rev.* 43, 72–82.
- Zahedi, A.R., Labbafi, S., Ghaffarinezhad, A., Habibi, K., 2021. Design, construction and performance of a quintuple renewable hybrid system of wind/geothermal/biomass/solar/hydro plus fuel cell. *Int. J. Hydrog. Energy* 46, 6206–6224. <http://dx.doi.org/10.1016/j.ijhydene.2020.11.188>.
- Zupone, G.Lo, Amelio, M., Barbarelli, S., Florio, G., Scornaieni, N.M., Cutrupi, A., 2015. Levelized cost of energy: A first evaluation for a self balancing kinetic turbine. *Energy Procedia* 75, 283–293.