

Discharge Measurements Using a Broad-Band Acoustic Doppler Current Profiler

By Michael R. Simpson

United States Geological Survey
OPEN-FILE REPORT 01-1

8016-20

SACRAMENTO, CALIFORNIA
2001

U.S. DEPARTMENT OF THE INTERIOR
GALE A. NORTON, Secretary

U.S. GEOLOGICAL SURVEY
Charles G. Groat, Director

The use of firm, trade, and brand names in this report is for identification purposes only and does not constitute endorsement by the U.S. Geological Survey.

For additional information write to:

District Chief
U.S. Geological Survey
Placer Hall, Suite 2012
6000 J Street
Sacramento, CA 95819-6129

Copies of this report can be purchased from:

U.S. Geological Survey
Information Services
Box 25286
Federal Center
Denver, CO 80225

CONTENTS

Introduction	1
Purpose and Scope	1
A Short History of Acoustic Doppler Current Profiler Discharge Measurement	1
Chapter 1: Theory of Operation	3
Basic Acoustic Velocity Measurement Principles	3
The Physics of Sound	3
The Doppler Principle Applied to Moving Objects	3
Measuring Doppler Shifts Using Acoustic Backscatter	4
Measuring Doppler Shifts from a Moving Platform.....	5
Radial Motion	5
Acoustic Doppler Current Profiler Beam Geometry	6
Calculating Three-Dimensional Velocity Components	6
Beam Scenarios	6
The Fourth Beam and Error Calculations	7
Acoustic Doppler Current Profiler Water-Velocity Profile Measurements.....	8
Acoustic Doppler Current Profiler-Measured Profiles Compared with Conventional Current Meter	
Measurements	8
Time Gating: Measuring Doppler Shifts from Different Depths.....	8
Bottom Tracking	9
Acoustic Doppler Current Profiler Limitations for Velocity-Profile Measurements	9
Range Limitations.....	9
Side-Lobe Interference	11
Effects of Different Beam Angles.....	12
Blanking Distance.....	13
Instrument Development: Solving the Problem of Velocity-Measurement Uncertainty	13
Random and Bias Error	13
Random Error	13
Bias Error.....	13
Pitch and Roll	14
Beam-Angle Error	15
Narrow-Band and Broad-Band Doppler Shift Measurements	15
Narrow-Band Doppler Shift Measurements	16
Broad-Band Doppler Shift Measurements	17
Differences Between Phase-Shift Measurements and Lag-Spacing Measurements (Time Dilation)	21
Bottom-Tracking Limitations	21
The Broad-Band Acoustic Doppler Current Profiler: Overcoming the Self-Noise Problem.....	22
Error Sources Unique to Broad-Band Acoustic Doppler Current Profilers.....	22
Random Uncertainty Caused by Self Noise	23
Summary.....	26
Chapter 2: Acoustic Doppler Current Profiler Discharge-Measurement Principles	27
Parts of an Acoustic Doppler Current Profiler Discharge Measurement	27
Velocity Cross-Product Measurement Using an Acoustic Doppler Current Profiler.....	27
General Equation	27
The General Equation, as Applied to Acoustic Doppler Current Profiler Moving-Boat Measurements.....	27
Properties of the Acoustic Doppler Current Profiler Measured Cross Product	28
Integrating the Cross Product Over the Water Depth	28
Estimating Cross Products in the Unmeasured Portions of the Profile	29
Blanking Distance.....	29

Side-Lobe Interference.....	29
Evolution of the One-Sixth Power-Curve Estimation Technique	30
Integration, By Time, Over the Width of the Cross Section	31
Estimating Discharge Near the Channel Banks	31
Determination of Total River Discharge—Putting it All Together.....	32
Discharge-Measurement Software	32
Summary	33
Chapter 3: R.D. Instruments, Inc., Broad-Band Acoustic Doppler Current Profiler Measurement Modes.....	35
Measurement Modes—Why?.....	35
Water Modes	35
Water Mode Zero (WM0)	35
Water Mode 1 (WM1)	35
Water Mode 4 (WM4).....	37
Water Mode 5 (WM5).....	37
Ambiguity Velocity Revisited	37
Water Mode 7 (WM7).....	37
Water Mode 8 (WM8).....	38
Range/Speed “Windows” for Water Modes 1, 5, and 8	38
Bottom-Track Modes	38
The Bottom Reflection.....	38
Bottom-Track Mode 4 (BM4).....	40
Bottom-Track Mode 5 (BM5).....	40
Summary	40
Chapter 4: Acoustic Doppler Current Profiler Hardware and Ancillary Equipment.....	41
Where Do We Start?.....	41
Acoustic Doppler Current Profiler Equipment.....	41
Acoustic Doppler Current Profiler Pressure Case and Transducer Assembly.....	41
Power Supply and Communications Interface	42
Acoustic Doppler Current Profiler Discharge-Measurement Software.....	45
Documentation	45
Ancillary Equipment	45
Measurement Platform or Vessel Requirements	45
Laptop Computer	48
Acoustic Doppler Current Profiler Mounts.....	51
Range Finder or Method for Estimating Distance to Shore.....	52
Trolling Motors/Plates.....	55
Miscellaneous Measurement Equipment	55
Installation of the Broad-Band Acoustic Doppler Current Profiler.....	56
Mounting the Acoustic Doppler Current Profiler on the Vessel.....	56
Deck-Unit and Power-Supply Connections	57
Acoustic Doppler Current Profiler Cables and Connectors	58
Broad-Band Acoustic Doppler Current Profiler.....	58
Workhorse Rio Grande.....	59
Summary	60
Chapter 5: Broad-Band Acoustic Doppler Discharge-Measurement System Configuration	63
Discharge-Measurement Software—“Transect”.....	63
Transect Configuration.....	63
Creation of a Preliminary Configuration File Using Transect Modules	63
Communications Setup	63
Calibration Setup.....	64
Planning Setup	66
The Configuration File, in Detail	68
The Communications Section	69
Ensemble Out Section.....	69
Acoustic Doppler Current Profiler Hardware Section	70
Direct Commands Section	70

Water-Track Commands.....	72
WSnnn.....	72
WNnnn.....	72
WPnnnn.....	72
WFnnnn.....	73
WDnnn nnn nnn.....	73
Bottom-Track Commands.....	73
BAnnn.....	73
BCnnn.....	73
BPnnn.....	73
BXnnnn.....	73
&Rnn.....	73
General Commands.....	74
ESnn.....	74
EXnnnnn.....	74
Recording Section.....	74
Calibration Section.....	75
Processing Section.....	77
Graphics Section.....	77
History Section.....	77
Finishing the Preliminary Configuration File: Required Commands.....	77
Transect Release Enhancements (2.80 and Later).....	80
Summary.....	84
Chapter 6: Data Acquisition.....	85
Operation of Transect Software.....	85
Loading the Configuration File.....	85
Starting the Transect Acquire Module.....	85
Transect-Data Displays.....	86
Transect-Data Recording.....	89
Summary.....	89
Chapter 7: Discharge-Measurement Procedure.....	91
Cross-Section Reconnaissance.....	91
Premeasurement Checkout.....	91
Boat-Maneuvering Techniques.....	92
Starting the Cross-Section Traverse.....	92
During the Cross-Section Traverse (Transect Tips and Tricks).....	93
Ending the Cross-Section Traverse.....	94
Alternate Techniques Used During Low-Flow Conditions.....	94
What Constitutes a “Good” Discharge Measurement?.....	95
Archival of Acoustic Doppler Current Profiler Discharge-Measurement Data.....	95
Summary.....	98
Chapter 8: Discharge-Measurement Review and Assessment.....	101
Configuration-File Review.....	101
River Conditions.....	101
Acoustic Doppler Current Profiler Hardware.....	101
Acoustic Doppler Current Profiler Direct Commands.....	101
Calibration Section.....	102
Transect Software Playback.....	102
Missing Ensembles.....	102
Error Caused By Sediment Movement Near the Bottom.....	103
Large Magnitudes of the Unmeasured Layers.....	104
Low-Velocity Measurements.....	105
Power-Curve-Fit Applicability.....	105
Edge Values.....	106
Shiptrack.....	107

Summary	108
Chapter 9: Discharge-Measurement Error	111
A Review of Major Acoustic Doppler Current Profiler Velocity-Measurement Limitations and Uncertainties.....	111
Limitations	111
Range Limitations	111
Side-Lobe Interference.....	111
Unmeasured Velocity Due to Blanking Distance and Transducer Draft	111
Random and Systematic Uncertainty	112
Random Uncertainty Due to Self Noise and Lag Distance.....	112
Systematic Uncertainty Due to Velocity Ambiguity	113
Systematic Uncertainty in Speed of Sound Due to Temperature	113
Systematic Uncertainty in Speed of Sound Due to Salinity.....	114
Systematic Uncertainty Due to Incorrect Beam Geometry.....	114
Minimizing Uncertainty in Velocity Profiles	114
Errors Affecting the Accuracy of Discharge Measurements	115
Simplified Random-Error Model	115
Bias Error	118
Instrument-Caused Bias Error.....	118
Beam-Angle Errors	119
Depth-Measurement Errors	119
Speed-of-Sound Errors Due to Temperature and Salinity Gradients	119
Bias Error Due to Incorrect Estimation of Unmeasured Velocities	
Near the Water Surface and Channel Bottom	120
Operator-Caused Bias Error	120
Incorrect Transducer Draft	121
Improper Broad-Band Acoustic Doppler Current Profiler Mounting	121
Incorrect Edge-Distance Estimates	121
Incorrect Estimated Edge Shapes.....	121
Bottom Movement	122
Configuration-File Error	122
Poor Choice of Cross Sections	122
Common Sense Rules	122
Summary	122
References Cited	123

FIGURES

Chapter 1. Theory of Operation

1.1.–1.40. Graphic illustrations showing:

1.1. Christian Johann Doppler.....	3
1.2. Stationary wave observer	4
1.3. Moving wave observer	4
1.4. Magnified view of backscatterers.....	4
1.5. An acoustic pulse being backscattered.....	5
1.6. Reflected pulse showing two Doppler shifts	5
1.7. Effect of radial motion on Doppler shift	5
1.8. Velocity components	6
1.9. Downward-looking, convex-head acoustic Doppler current profiler	6
1.10. Boat-mounted acoustic Doppler current profiler with the “Janus” configuration.....	6
1.11. Northwest-moving water-velocity vector and the resulting Doppler shifts from a hypothetical, three-beam sonar	7
1.12. Northeast-moving water-velocity vector and the resulting Doppler shifts for a hypothetical, three-beam sonar	7
1.13. Acoustic Doppler current profiler measuring a homogeneous velocity field.....	8
1.14. Nonhomogeneous velocity field bounded by the acoustic Doppler current profiler beams	8
1.15. Analogy of a conventional current-meter string to an acoustic Doppler current profiler (ADCP) profile.....	8
1.16. Acoustic Doppler current profiler (ADCP) time gating	9
1.17. Short and long bottom-track pulse	9
1.18. Spectrograph of received Doppler signal	10
1.19. Phase change due to size and speed differences of scatterers	10
1.20. Echo returned from a cloud of particles.....	10
1.21. Acoustic Doppler current profiler transducer beam pattern	11
1.22. Reflected signal strength indicators (RSSI) for a four-beam acoustic Doppler current profiler	12
1.23. Polar plot of 10-ping broad-band acoustic Doppler current profiler velocity averages	14
1.24. Polar plot of about 200-ping broad-band acoustic Doppler current profiler velocity averages	15
1.25. Pitch and roll axes for a boat-mounted acoustic Doppler current profiler	16
1.26. Bin positions during an acoustic Doppler current profiler roll occurrence.....	16
1.27. Freeway strobe-light system used to measure vehicle speed	17
1.28. Narrow-band acoustic Doppler current profiler (ADCP) shift measurement	17
1.29. Acoustic pulse pair approaching a stationary particle.....	18
1.30. Acoustic pulse pair reflected from a stationary particle	18
1.31. Acoustic pulse pair approaching a moving particle	18
1.32. Acoustic pulse pair reflected from a moving particle.....	19
1.33. Acoustic pulse pair with a small reflected pressure wave	19
1.34a. Race track analogy during the first strobe flash	20
1.34b. Race track analogy during the second strobe flash	20
1.35. Explanation of ambiguity velocity	21
1.36. Description of time dilation compared with phase-angle difference	22
1.37. Effect of bottom-track pulse width on bias caused by bottom movement	23
1.38. Narrow pulse pairs compared with wide pulse pairs.....	24

FIGURES—Continued

1.39. Phase-coded pulse pair	24
1.40. Effects of code element lag on correlation.....	25
Chapter 2. Acoustic Doppler Current Profiler Discharge-Measurement Principles	
2.1–2.8. Graphic illustrations showing:	
2.1. Cross-product vectors during a cross-section traverse.....	28
2.2. Properties of the water-velocity/boat-velocity cross product.....	28
2.3. Acoustic Doppler current profiler-beam pattern showing side-lobe features.....	29
2.4. Hypothetical shape of a parasitic, side-lobe pattern.....	29
2.5. Example velocity profile showing measured and missing <i>f</i> values.....	30
2.6. Example velocity profile of one-sixth power-curve fit and typical <i>f</i> values.....	30
2.7. Unmeasured areas in a typical acoustic Doppler current profiler discharge-measurement cross section.....	31
2.8. Edge-value estimation scheme described by equations 2.8, 2.9, and 2.10.....	32
Chapter 3. R.D. Instruments, Inc., Broad-Band Acoustic Doppler Current Profiler Measurement Modes	
3.1–3.3. Graphic illustrations showing:	
3.1. Choosing the proper measurement mode is difficult.....	35
3.2. Depth/range/speed-operational “windows” for water modes 1, 5, and 8.....	36
3.3. Acoustic Doppler current profiler-backscattered intensity with depth showing the bottom reflection.....	39
Chapter 4. Acoustic Doppler Current Profiler Hardware and Ancillary Equipment	
4.1. Graphic illustration, “Which equipment do we need?”	41
4.2–4.24. Photograph showing:	
4.2. A 1,200-kilohertz broad-band acoustic Doppler current profiler with attached pipe brackets	42
4.3. An R.D. Instruments, Inc., 600-kilohertz Workhorse “Rio Grande” acoustic Doppler current profiler	43
4.4. Front and rear view of an R.D. Instruments, Inc., acoustic Doppler current profiler deck unit	44
4.5. Connector cable for attachment of R.D. Instruments, Inc., broad-band acoustic Doppler current profiler to accompanying deck unit.....	45
4.6. Tethered acoustic Doppler current profiler discharge measurement platform	46
4.7. Radio-controlled, 12-foot, broad-band acoustic Doppler current profiler platform.....	46
4.8. Two views of an acoustic Doppler current profiler side-swing mount on a 30-meter (95-foot) vessel.....	47
4.9. Side-swing mount on a 6-meter (20-foot) Boston Whaler for an acoustic Doppler current profiler.....	48
4.10. Side-swing mount on a 4.5-meter (15-foot) Boston Whaler for an acoustic Doppler current profiler.....	49
4.11. Acoustic Doppler current profiler mount for an inflatable dinghy.....	50
4.12. Laptop computer screen in diffuse sunlight.....	50
4.13. Laptop computer with missing plastic doors and port covers.....	51
4.14. Inexpensive acoustic Doppler current profiler mount	51
4.15. Aluminum acoustic Doppler current profiler mount	52
4.16. Sea-chest mount for a narrow-band acoustic Doppler current profiler	53
4.17. Mount used by the U.S. Geological Survey Tampa, Florida, Subdistrict	54
4.18. Hydraulic mount used by the U.S. Geological Survey Indiana District	55
4.19. “Toggle” mount used by the U.S. Geological Survey Kentucky District	56
4.20. Swing mount variation used by the U.S. Geological Survey Illinois District.....	57
4.21. Detachable swing mount used by the U.S. Geological Survey Idaho District.....	58
4.22. Optical range finders used to estimate near-shore distances.....	58
4.23. Typical battery-operated trolling motor used when making acoustic Doppler current profiler discharge measurements.....	59
4.24. Two views of a steering adaptor that connects the trolling motor to the main engine.....	60

FIGURES—Continued

4.25. Graphic illustration showing interconnections of the broad-band acoustic Doppler current profiler (BB-ADCP) deck unit with other components of the acoustic Doppler current profiler discharge-measurement system.....	61
Chapter 5. Broad-Band Acoustic Doppler Discharge-Measurement System Configuration	
5.1–5.9. Graphic illustrations showing:	
5.1. BB-TALK terminal emulator help screen	64
5.2. Transect main menu showing menu choices	65
5.3. Communication acoustic Doppler current profiler (ADCP) submenu	65
5.4. Transect main menu showing calibration menu choices.....	66
5.5. Calibration offsets submenu screen	66
5.6. Calibration scaling submenu screen.....	67
5.7. Transect main menu showing planning menu choices	67
5.8. Planning setup submenu screen	68
5.9. Planning acoustic Doppler current profiler submenu screen.....	69
5.10–5.11. Graphics showing:	
5.10. Communication, ensemble out, and acoustic Doppler current profiler (ADCP) hardware sections of the configuration file.....	70
5.11. Direct command and recording sections of the configuration file	71
5.12. Graphic illustration showing planning acoustic Doppler current profiler (ADCP) menu in expert mode (Alt-M).....	72
5.13–5.20. Graphics showing:	
5.13. Calibration section of the configuration file.....	76
5.14. Processing, graphics, and history sections of the configuration file	78
5.15. Hardware and direct command sections of the configuration file.....	79
5.16. Recording section of the configuration file	80
5.17. Calibration section of the configuration file.....	81
5.18. Graphics and history sections of the configuration file.....	82
5.19. Edge-slope coefficient in the Transect 2.80+ configuration file.....	83
5.20. Transect 2.80+ directives in the processing section of the configuration file	84
Chapter 6. Data Acquisition	
6.1–6.7. Graphic illustrations showing:	
6.1. Transect software main menu.....	85
6.2. Transect software Acquire introductory screen	86
6.3. Transect software Acquire profile menu screen	87
6.4. Transect software Acquire velocity contour plot screen	87
6.5. Transect software Acquire intensity contour plot.....	88
6.6. Transect software Acquire shiptrack plot.....	88
6.7. Transect software Acquire tabular display screen	89
Chapter 7. Discharge-Measurement Procedure	
7.1. Graphic illustration showing improper discharge-measurement technique.....	91
7.2–7.8. Photographs showing:	
7.2. Discharge-measurement cross section on Dutch Slough near Oakely, California.....	91
7.3. Broad-band acoustic Doppler current profiler mount being deployed vertically.....	92
7.4. Discharge-measurement log sheet/note.....	92
7.5. Acoustic Doppler current profiler vessel at the beginning of a discharge measurement	93
7.6. Acoustic Doppler current profiler vessel near center channel.....	93
7.7. Acoustic Doppler current profiler vessel at the end of a cross-section traverse.....	94
7.8. Winching system used to move an acoustic Doppler current profiler vessel at slow speeds	94
7.9–7.10. Graphics showing:	
7.9. Example of an acoustic Doppler current profiler (ADCP) discharge-measurement note (front).....	96
7.10. Example of an acoustic Doppler current profiler discharge-measurement note (back)	97

FIGURES—Continued

7.11. Graph showing discharge-measurement data from a tidally affected gaging station on a tributary of the San Joaquin River	98
7.12. Discharge-measurement log sheet	99
Chapter 8. Discharge-Measurement Review and Assessment	
8.1–8.11. Graphic illustrations showing:	
8.1. Transect containing missing ensembles caused by a loss of bottom tracking.....	102
8.2. Transect software shiptrack plot of an anchored vessel	104
8.3. Transect software edge-value screen showing unmeasured layers	104
8.4. Transect shiptrack plot of acoustic Doppler current profiler-measured velocities on a slow-moving river	105
8.5. Transect software discharge profile plot.....	106
8.6. Transect software edge-value screen.....	106
8.7. Transect software shiptrack plot.....	107
8.8. Transect software shiptrack plot with operator’s initials.....	108
8.9. Transect software profile plot of “initials”	108
8.10. Transect shiptrack screen	109
8.11. Transect subsectioning menu screen	109
Chapter 9. Discharge-Measurement Error	
9.1–9.2. Graphic illustrations showing:	
9.1. Screen shot of Transect software showing tabular output.....	112
9.2. Screen shot of BB-SETUP software showing a typical setup for a 1,200-kilohertz broad-band acoustic Doppler current profiler	113
9.3–9.4. Graphs showing:	
9.3. Depth error due to speed of sound that is uncorrected for temperature	114
9.4. Depth error due to speed of sound that is uncorrected for salinity	114
9.5–9.9. Graphic illustrations showing:	
9.5. Discharge error using a boat speed of about 0.3 meter per second (1 foot per second) and about 0.9 meter per second (3 feet per second)	116
9.6. Discharge error using a boat speed of about 0.9 meter per second (3 feet per second) in 9 meters (30 feet) of depth	116
9.7. QERROR setup screen	117
9.8. Discharge error with a mean water velocity of about 0.3 meter per second (1.0 foot per second)	118
9.9. Discharge error in deep water [9 meters (30 feet)] with a mean river velocity of about 0.15 meter per second (0.5 foot per second).....	119
9.10–9.11. Graphs showing:	
9.10. Discharge error in shallow water [3 meters (10 feet)] with a mean river velocity of about 0.15 meter per second (0.5 foot per second).....	120
9.11. Exaggerated instance of depth error due to limitations of the acoustic beams	121

TABLES

Chapter 1. Theory of Operation	
1.1. Comparison of narrow-band and broad-band single-ping standard deviation.....	26
Chapter 3. R.D. Instruments, Inc., Broad-Band Acoustic Doppler Current Profiler Measurement Modes	
3.1. Mode 1 single-ping standard deviation using three different values for the WV command	36
3.2. Setup and performance values for water mode 5 operation (WZ05).....	38
3.3. Setup and performance values for water mode 8 operation (WZ05).....	39
3.4. Minimum depth ranges for bottom-track modes 4 and 5	40
Chapter 5. Broad-Band Acoustic Doppler Discharge-Measurement System Configuration	
5.1 Optimum bin size (WSnnn) for acoustic Doppler current profiler (ADCP) discharge-measurement applications	72

TABLES—Continued

Chapter 9. Discharge-Measurement Error

9.1 Approximate maximum depth range for 300-, 600-, and 1,200-kilohertz acoustic Doppler current profiler (ADCP) systems 111

9.2 Approximate depth-averaged single-ping precision for 1,200-, 600-, and 300-kilohertz broad-band acoustic Doppler current profiler-measured water velocities using mode 1 operation, 20° beams, and WV190 115

CONVERSION FACTORS, VERTICAL DATUM, ABBREVIATIONS, AND ACRONYMS

	Multiply	By	To obtain
	centimeter (cm)	0.3937	inch (in.)
	centimeter per second (cm/s)	.3281	foot per second (ft/s)
	cubic meter per second (m ³ /s)	35.3147	cubic foot per second (ft ³ /s)
	cubic meter per second per second (m ³ /s/s)	35.3147	cubic foot per second per second (ft ³ /s/s)
	decibel per meter (dB/m)	.3048	decibel per foot (dB/ft)
	decimeter (dm)	3.937	inch (in.)
	kilometer (km)	.6214	mile (mi)
	meter (m)	3.281	foot (ft)
	meter per second (m/s)	3.281	foot per second (ft/s)
	millimeter (mm)	.03937	inch (in.)
	millimeter per second (mm/s)	.03937	inch per second (in./s)
	square meter per second per second (m ² /s/s)	10.7639	square foot per second per second (ft ² /s/s)

Temperature in degrees Celsius (°C) may be converted to degrees Fahrenheit (°F) as follows:

$$^{\circ}\text{F} = (1.8 \times ^{\circ}\text{C}) + 32$$

Sea level: In this report, “sea level” refers to the National Geodetic Vertical Datum of 1929 (NGVD of 1929)—a geodetic datum derived from a general adjustment of the first-order level nets of both the United States and Canada, formerly called Sea Level Datum of 1929.

Abbreviations and Acronyms

dB	decibel	CFG	configuration (file)
Hz	hertz	CPU	central processing unit
hp	horsepower	CV	coefficient variation
K, kB	kilobyte	DC	direct current
kHz	kilohertz	DOI	U.S. Department of the Interior
Mb	megabyte	EGA	extended graphics array
ppt	parts per thousand	GPS	Global Positioning System
rpm	revolutions per minute	IBM	International Business Machines
s	second	LCD	liquid crystal display
V	volt	LED	luminescent electronic display
W	watt	MS DOS	Microsoft Disk Operating System
AC	alternating current	PC	personal computer
ADCP	acoustic Doppler current profiler	QA	quality assurance
ASCII	American standard code for information interchange	RDI	R.D. Instruments, Inc.
BB-ADCP	broad-band acoustic Doppler current profiler	RSSI	reflected signal strength indicator
BNC	bayonet style coaxial	USGS	U.S. Geological Survey
CD-ROM	compact disk, read-only memory		

Discharge Measurements Using a Broad-Band Acoustic Doppler Current Profiler

By Michael R. Simpson

INTRODUCTION

The measurement of unsteady or tidally affected flow has been a problem faced by hydrologists for many years. Dynamic discharge conditions impose an unreasonably short time constraint on conventional current-meter discharge-measurement methods, which typically last a minimum of 1 hour. Tidally affected discharge can change more than 100 percent during a 10-minute period. Over the years, the U.S. Geological Survey (USGS) has developed moving-boat discharge-measurement techniques that are much faster but less accurate than conventional methods. For a bibliography of conventional moving-boat publications, see Simpson and Oltmann (1993, page 17).

The advent of the acoustic Doppler current profiler (ADCP) made possible the development of a discharge-measurement system capable of more accurately measuring unsteady or tidally affected flow. In most cases, an ADCP discharge-measurement system is dramatically faster than conventional discharge-measurement systems and has comparable or better accuracy. In many cases, an ADCP discharge-measurement system is the only choice for use at a particular measurement site.

ADCP systems are not yet “turnkey”; they are still under development, and for proper operation, require a significant amount of operator training. Not only must the operator have a rudimentary knowledge of acoustic physics, but also a working knowledge of ADCP operation, the manufacturers' discharge-measurement software, and boating techniques and safety.

Purpose and Scope

The purpose of this report is to describe ADCP operating techniques, fundamental ADCP theory, ADCP discharge-measurement theory, and vessel mounts and operating techniques required for ADCP

discharge measurements. It is not intended to replace the “hands-on,” USGS-approved training required for all ADCP discharge-measurement system operators. This report only describes the Microsoft Disk Operating System (MS DOS) version of the discharge-measurement software, Transect, and will have to be revised to include future versions that run under Microsoft Windows. The report also only describes the configuration and use of the R.D. Instruments, Inc. (RDI), broad-band ADCP (BB-ADCP). Subsequent modifications to the BB-ADCP will be included in updates to this report if these modifications significantly change the configuration of the ADCP or if discharge-measurement techniques must be changed. This report also will be updated if another manufacturer's ADCP is used to measure discharge by a significant number of USGS users.

A Short History of Acoustic Doppler Current Profiler Discharge Measurement

In 1982, an ADCP was used to measure the discharge of the Mississippi River at Baton Rouge, Louisiana (Christensen and Herrick, 1982). The test results were encouraging, differing less than 5 percent from simultaneous measurements made with conventional moving-boat methods. However, the computer software and hardware were incapable of processing the velocity data provided by the profiler on a real-time basis; the discharge measurements had to be computed after the fact. Although this technology looked very promising at the time of these tests, computer and Doppler signal-processing technology had not progressed to the level needed to collect and compute reliable river and estuarine discharge measurements.

In 1985, the USGS purchased a narrow-band ADCP to be used for the development of a discharge-measurement system (an explanation of the differences between narrow-band and BB-ADCPs is given in

chap. 1). This discharge-measurement system was successful (Simpson and Oltmann, 1993) but, because of minimum depth limitations, the narrow-band ADCP was usable only in rivers and estuaries with depths greater than 3.4 meters (m) [11.5 feet (ft)].

Because of depth and measurement precision limitations of the narrow-band ADCP, the ADCP manufacturer began exploring a slightly different area of acoustic technology, which has been termed "broad-band." In 1991, a prototype BB-ADCP was developed and tested. The BB-ADCP short-term random error (standard deviation of measured water velocities) was reported to be an order of magnitude lower than that of the narrow-band system and, because of this, could be optimized for shallow-water operation.

The USGS was interested in this technology because of its application to shallow water and purchased one of the first production models of the BB-ADCP from RDI in February 1992 to be evaluated for use in the measurement of river discharge. This evaluation is ongoing in the California District and has been joined by several other districts of the USGS. Morlock (1996) evaluated the BB-ADCP for discharge measurement at selected locations throughout the United States. This evaluation compared discharges measured utilizing a BB-ADCP with discharges measured at 12 stream-gaging sites having stable stage-discharge relations. The results of the evaluation showed that the BB-ADCP system can be used to accurately measure discharge at sites similar to those measured by Morlock (1996).

The manufacturer has since developed smaller versions of the BB-ADCP. Two such instruments are

the "Workhorse" with a bottom-tracking option (chap. 1) and the "Rio Grande," which is a Workhorse with built-in bottom-tracking capability. Because the manufacturer has four types of ADCPs capable of measuring river discharge (narrow-band, broad-band, Workhorse, and Rio Grande), they will be referred to as ADCP discharge-measurement systems in this report, and the instrument will be referred to as an ADCP, unless details specific to a particular model are discussed.

The ADCP discharge-measurement system may be the only feasible, accurate method for measuring discharge in tidally affected rivers and estuaries, as well as in rivers or canals with unsteady flow (Simpson and Oltmann, 1993). The ADCP also has proven useful as a substitute for conventional discharge-measurement techniques in many upland rivers with depths too deep for wading measurements.

On the other hand, the setup and operation of the ADCP for discharge measurements is complicated, compared with conventional methods. Configuration of the ADCP for discharge-measurement use requires a working knowledge of conventional discharge-measurement principles, as well as a basic knowledge of acoustics and Doppler shift measurement techniques. With the help of this report, attendance at a USGS-approved ADCP discharge-measurement course, and the manufacturer's documentation, it is hoped that an interested individual can gain the skills needed to accurately measure river discharge using an ADCP.

CHAPTER 1: THEORY OF OPERATION

Basic Acoustic Velocity Measurement Principles

Before the operational aspects of an ADCP measurement can be understood, some of the basic physical properties of sound and sound propagation through different mediums must be examined. This chapter introduces basic acoustic Doppler velocity measurement principles and some of the problems associated with such measurements. Much of the information in this chapter was taken from R.D. Instruments, Inc. (1989, 1996).

The Physics of Sound

What commonly is perceived as sound is a vibration of our eardrums caused by the arrival of pressure waves. The eardrum transfers the pressure-wave information to parts of the inner ear where the mechanical energy of the pressure waves is converted to an electrical signal. The brain interprets this electrical signal as sound.

Sound waves can occur in most media (water, air, and solids) and are similar to water waves; sound waves have crests and troughs that correspond to bands of high and low air pressure, and water waves have crests and troughs that correspond to high and low water-level elevations. Pitch (frequency) of sound waves increases as the wavelength (the distance between the wave peaks) becomes shorter. This frequency, or pitch, usually is expressed in hertz (Hz). One hertz equals one wave (cycle) per second. The human ear can hear frequencies from about 40 Hz to about 24 kilohertz (kHz) (24,000 Hz). These frequencies are dubbed the “sonic” frequencies. Sound frequencies below about 40 Hz are called “subsonic,” and sound frequencies above 25,000 Hz are called “ultrasonic.”

The Doppler Principle Applied to Moving Objects

The ADCP uses sound to measure water velocity. The sound transmitted by the ADCP is in the ultrasonic range (well above the range of the human ear). The lowest frequency used by commercial ADCPs is around 30 kHz, and the common range used by the USGS for riverine measurements is between 300–3,000 kHz.

The ADCP measures water velocity using a principle of physics discovered by Christian Johann Doppler (1842) (fig. 1.1). Doppler’s principle relates the change in frequency of a source to the relative velocities of the source and the observer. Doppler (1842) stated his principle in the article, “Concerning the Coloured Light of Double Stars and Some Other Constellations in the Heavens,” while working in



Figure 1.1. Christian Johann Doppler.

Prague, Czechoslovakia. The Doppler principle can be described best using the water-wave analogy (figs. 1.2, 1.3).

Figure 1.2 shows a stationary observer watching a series of waves that are passing at a rate of one wave per second. This rate is analogous to a transmit frequency of 1 Hz. In figure 1.3, the wave observer is boating toward the wave source at a rate of four wavelengths per second. Because the waves are passing at a rate of one wave per second, the observer notices the passage of five waves during each second of his boating trip. He senses that the rate of the passing waves is 5 Hz, though the wave source is still emitting waves at 1 Hz. This phenomenon is known as the Doppler effect.

Many people have experienced the Doppler effect while on a busy street. The sound of a car horn seems to drop in frequency as the car passes and recedes from the observer. The apparent lowering of frequency is called the Doppler shift (fig. 1.3). The car is a moving sound-wave source; therefore, when the car is approaching an observer, the frequency of the sound waves striking the observer’s ear drums is proportional to the speed of the car (in wavelengths per second) plus the frequency of the car horn in hertz. When the car is receding from the observer, the frequency of the sound waves striking the observer’s ear drums is proportional

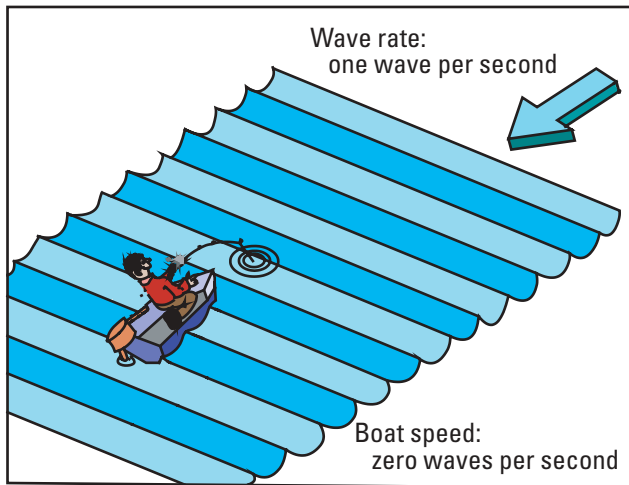

Figure 1.2. Stationary wave observer.

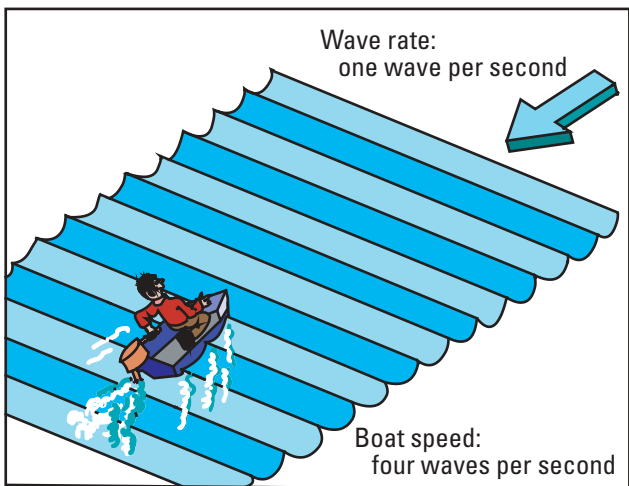

Figure 1.3. Moving wave observer.

to the frequency of the car horn (in hertz) minus the speed of the car (in wavelengths per second). If the exact source frequency is known and the observed frequency can be calculated, equation 1.1 can be used to calculate the Doppler shift due to the relative velocities of the source and observer (R.D. Instruments, Inc., 1989):

$$F_D = F_S \left(\frac{V}{C} \right) \quad (1.1)$$

where

F_D = the Doppler shift frequency, in hertz;

F_S = the transmitted frequency of the sound from a stationary source, in hertz;

V = relative velocity between the sound source and the sound wave receiver (the speed at which the observer is walking toward the sound source), in meters per second; and
 C = the speed of sound, in meters per second.

Note that:

- If the observer walks faster (V increases), the Doppler shift (F_D) increases
- If the observer walks away from the sound (V is negative), the Doppler shift (F_D) is negative
- If the frequency of the sound (F_S) increases, the Doppler shift (F_D) increases
- If the speed of sound (C) increases, the Doppler shift (F_D) decreases

Measuring Doppler Shifts Using Acoustic Backscatter

An ADCP applies the Doppler principle by bouncing an ultrasonic sound pulse off small particles of sediment and other material (collectively referred to as backscatterers) that are present, to some extent, even in optically clear water. A magnified view of the water column and the backscatterers “illuminated” by the sound pulse are shown in figure 1.4. There are, of course, exceptions to every rule, and in tow tanks and some natural rivers, backscatterer density can be too low for the proper operation of an ADCP.

The ADCP transmits an acoustic “ping,” or pulse into the water column and then listens for the return echo from the acoustic backscatterers in the water column. Upon receiving the return echo, the ADCP’s onboard signal-processing unit calculates the Doppler shift using a form of autocorrelation (the signal is compared with itself later). A schematic diagram of a transmitted acoustic pulse (ping) and the resulting reflected acoustic energy are shown in figure 1.5. Note

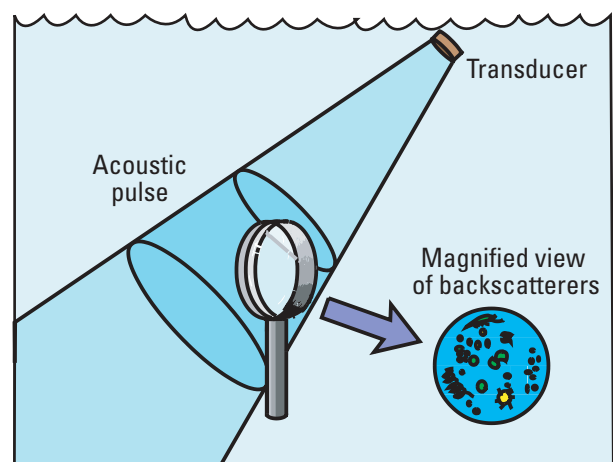

Figure 1.4. Magnified view of backscatterers.

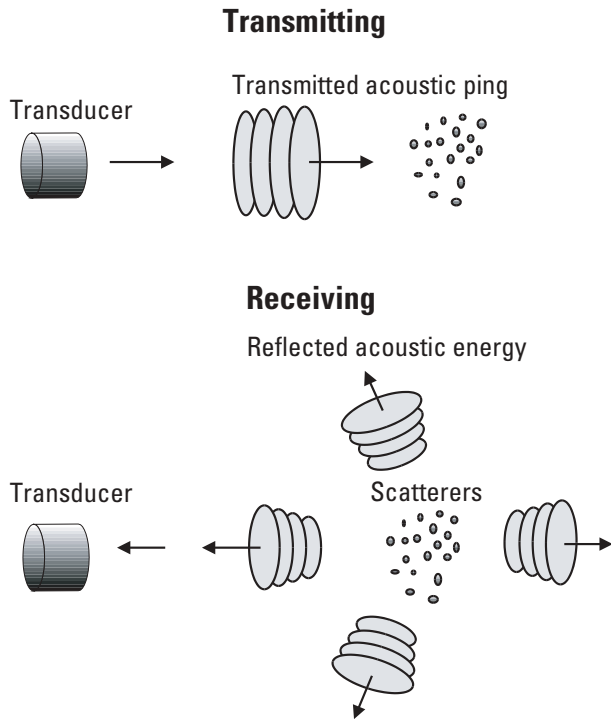

Figure 1.5. An acoustic pulse being backscattered.

that very little reflected acoustic energy is reflected back (backscattered) towards the transducer in figure 1.5; most of the acoustic energy is absorbed or reflected in other directions.

Measuring Doppler Shifts From a Moving Platform

When the scatterers are moving away from the ADCP, the sound (if it could be perceived by the scatterers) shifts to a lower frequency. This shift is proportional to the relative velocity between the ADCP and the scatterers (fig. 1.5). Part of this Doppler-shifted sound is backscattered towards the ADCP, as if the scatterers were the sound source (fig. 1.6). The sound is shifted one time (as perceived by the backscatterer) and a second time (as perceived by the ADCP transducer) (R.D. Instruments, Inc., 1989).

Because there are two Doppler shifts, equation 1.1 becomes equation 1.2:

$$F_D = 2 F_D \left(\frac{V}{C} \right) \quad (1.2)$$

If the sound source and receiver move, relative to the Earth, but stay at a fixed distance from one another, there is no Doppler shift. The Doppler shift exists only when sound sources and receivers move in relation to

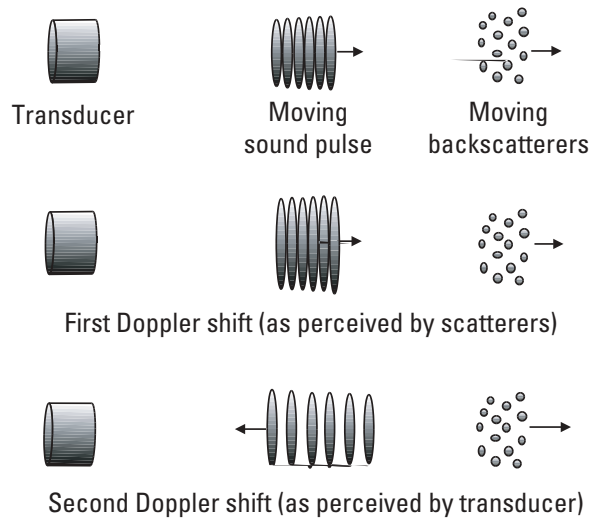

Figure 1.6. Reflected pulse showing two Doppler shifts.

each other. The Doppler shift between the source and the Earth exactly cancels the opposite shift between the Earth and the receiver (R.D. Instruments, Inc., 1989).

Radial Motion

Only radial motion, which is a change in distance between the source and receiver, will cause a Doppler shift. Figure 1.7 shows 1-second boat tracks in three different directions, relative to the wave source. Boat vector A is parallel with the wave direction; therefore, vector A encounters the full component of Doppler shift. Boat vector B is moving at an angle to the wave direction and encounters only a part of the Doppler shift component, whereas boat vector C (normal to the wave source) encounters no Doppler shift.

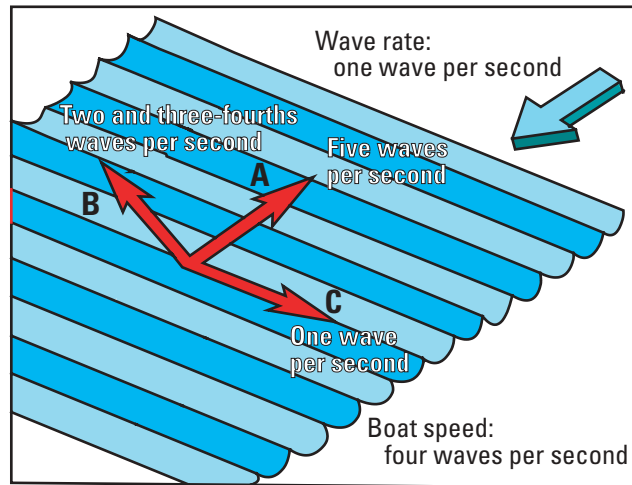

Figure 1.7. Effect of radial motion on Doppler shift.

Mathematically, this means the Doppler shift results from the velocity component in the direction of the line between the source and receiver (R.D. Instruments, Inc., 1989) as shown in equation 1.3:

$$F_D = 2 F_s \left(\frac{V}{C} \right) \cos(\theta) \quad (1.3)$$

where

θ = the angle between the relative-velocity vector and the line between the ADCP and scatterers (fig. 1.8).

Acoustic Doppler Current Profiler Beam Geometry

Calculating Three-Dimensional Velocity Components

In a vessel-mounted system, the transducers are mounted near the water surface and aimed downward. Figure 1.9 shows a typical ADCP. Note that there are four independently working acoustic beams with each beam angled 20–30° from the vertical axis of the transducer assembly. This configuration of beams is the so-called “Janus” configuration, named after the Greek God, Janus, who could simultaneously look forward and backward.

Beam Scenarios

To visualize the three-dimensional capabilities of the “Janus” configuration, refer to figure 1.10 while reading the following scenarios:

- If the starboard (90° left of forward) beam has a positive Doppler shift, the port (90° right of

forward) beam has a negative Doppler shift, and the forward and aft beams have no Doppler shift, then the water is flowing from starboard to port (or the water is still and the boat is sliding starboard)

- If the forward beam has a negative Doppler shift, the aft beam has a positive Doppler shift, and the

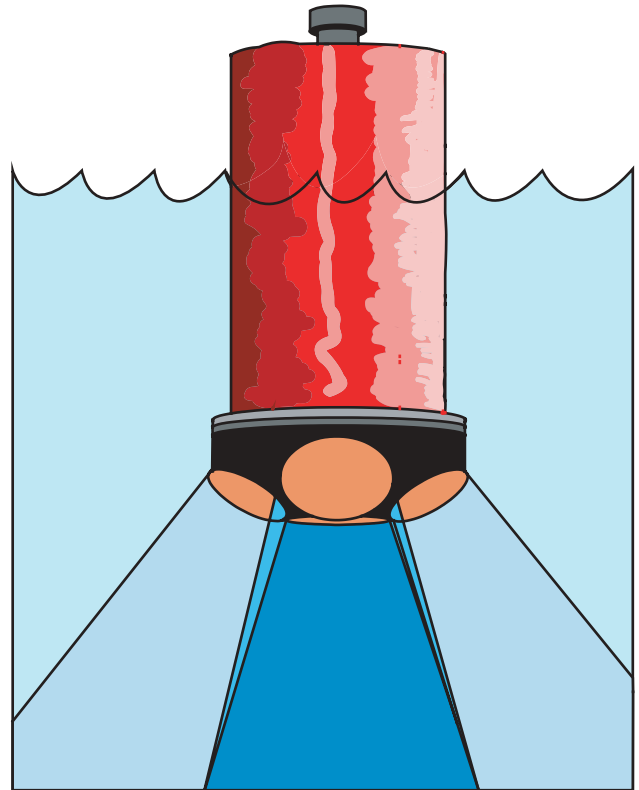

Figure 1.9. Downward-looking, convex-head acoustic Doppler current profiler.

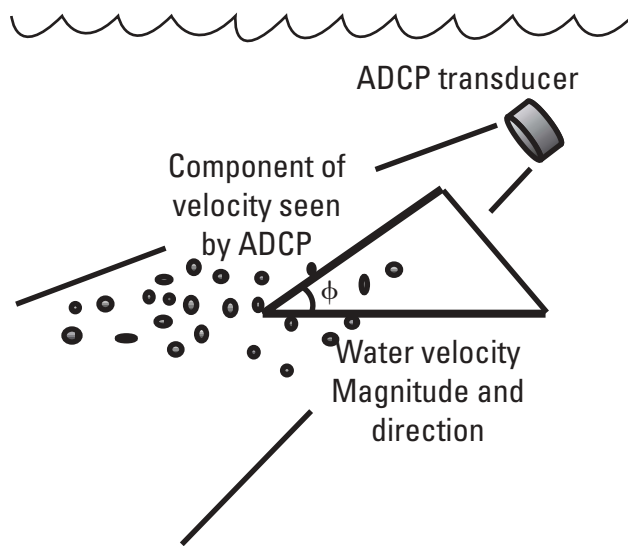

Figure 1.8. Velocity components. ADCP, acoustic Doppler current profiler.

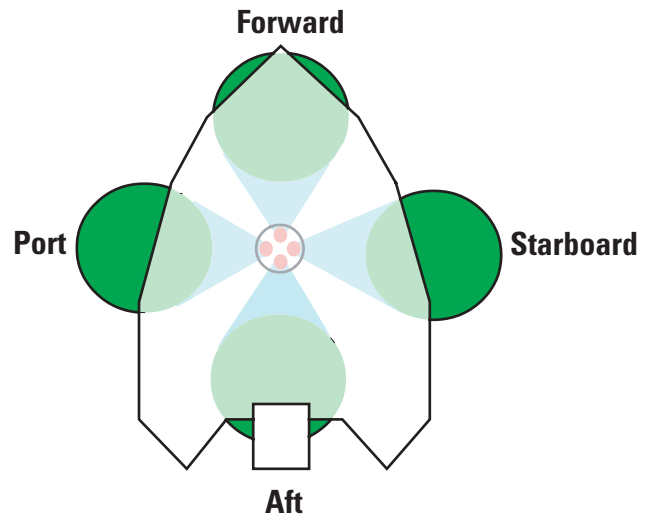

Figure 1.10. Boat-mounted acoustic Doppler current profiler with the “Janus” configuration.

starboard and port beams have no shift, then the water is flowing under the boat from aft to forward (or the water is still and the boat is backing)

- If the forward and port beams have a positive Doppler shift of magnitude 1 and the aft and starboard beams have a negative Doppler shift of magnitude 1, then water is passing under the boat from a point halfway between forward and port with a magnitude of the square root of 2, or 1.414 (or the water is still and the boat is crabbing toward the forward port quarter at a magnitude of 1.414)
- If all four beams have a positive Doppler shift, the water is flowing upward toward the hull of the boat (or the water is still and all personnel on the boat should don their life jackets)

The computation of velocity in three dimensions (x, y, z) requires at least three acoustic beams (figs. 1.11 and 1.12). Figure 1.11 shows a northwest-moving water-velocity vector and the resulting Doppler shifts from each of three acoustic beams (a hypothetical, three-beam sonar). Because the water-velocity vector is almost exactly at right angles to beam 2, the resulting Doppler shift on beam 2 is small. The water-velocity vector is approaching and is almost aligned with beam 3; therefore, beam 3 has a large, positive Doppler shift. The water-velocity vector is receding from, and is almost aligned with, beam 1; therefore, beam 1 has a large negative Doppler shift.

Figure 1.12 shows a northeast-moving water-velocity vector. Note that because the water-velocity vector almost is at right angles to beam 3, the resultant Doppler shift is small. The water-velocity vector is approaching beam 1 at an angle; therefore, beam 1 has a large positive Doppler shift. Beam 2 has a large

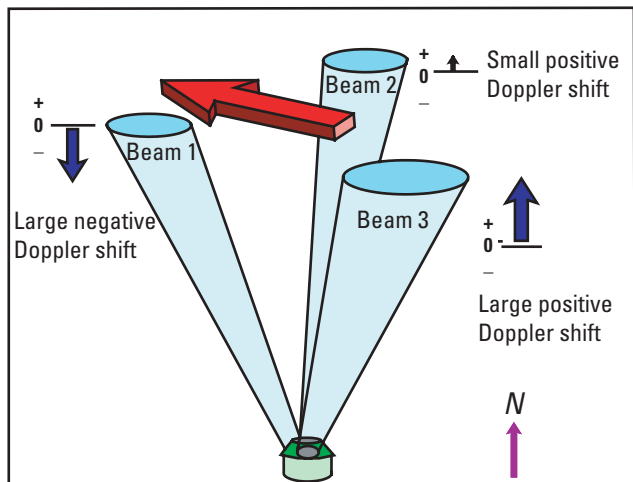

Figure 1.11. Northwest-moving water-velocity vector and the resulting Doppler shifts from a hypothetical, three-beam sonar.

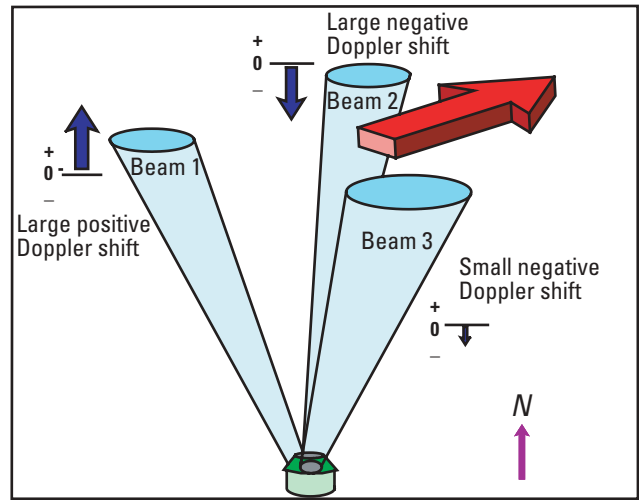

Figure 1.12. Northeast-moving water-velocity vector and the resulting Doppler shifts for a hypothetical, three-beam sonar.

negative Doppler shift because the water-velocity vector is receding from, but not perfectly parallel with, beam 2. This configuration also could measure vertical velocities. If all three beams have positive Doppler shifts, then a vertical component of water velocity moving toward the transducers is present. By using simple trigonometry, velocity components in three orthogonal coordinates can be calculated from Doppler shifts measured with three sonar beams.

The Fourth Beam and Error Calculations

Some ADCP manufacturers use a four-beam configuration and the fourth redundant beam is used to compute an error velocity. This error velocity can be used to test the assumption that flow volume of water bounded by the four measurement beams is homogeneous. Velocity homogeneity means that the water velocities do not change significantly in magnitude or direction within the confines of the acoustic beam footprint. Figure 1.13 shows a homogeneous velocity field bounded by the four beams of an ADCP.

If a velocity field existed as in figure 1.13, the ADCP would provide a nearly zero error velocity. Error velocity is defined as the difference between a velocity measured by one set of three beams versus a velocity measured by the other set of three beams during the same time frame. A difference between these two measurements could be caused by a bad or corrupt beam velocity or by nonhomogeneity (fig. 1.14). In practice, a small error velocity almost always exists because complete homogeneity of the velocity field rarely occurs during field measurements.

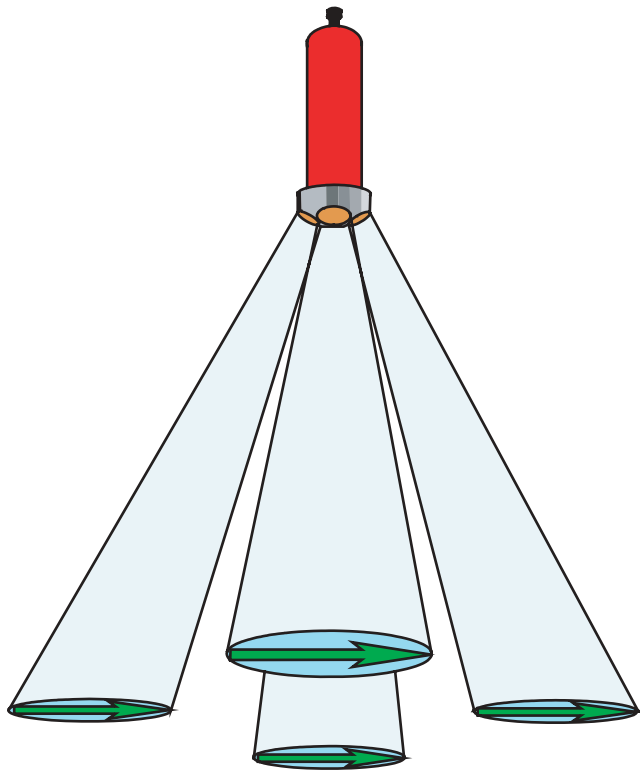

Figure 1.13. Acoustic Doppler current profiler measuring a homogeneous velocity field.

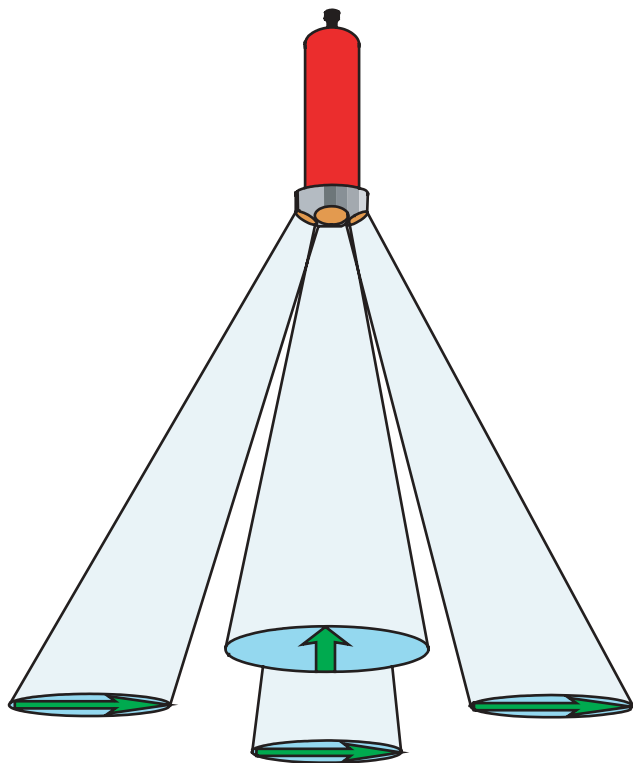

Figure 1.14. Nonhomogeneous velocity field bounded by the acoustic Doppler current profiler beams.

Acoustic Doppler Current Profiler Water-Velocity Profile Measurements

Acoustic Doppler Current Profiler-Measured Profiles Compared with Conventional Current Meter Measurements

The ADCP is best known for its capability to measure profiles of water velocity. A velocity profile can be compared roughly to using a number of point-velocity meters that are suspended in the vertical axis of a water-velocity field (fig. 1.15). Theoretically, the velocity measured by each conventional current meter is analogous to the velocities measured at the center of ADCP depth cells (fig. 1.15). However, the analogy between a string of current meters and an ADCP profile is not perfect. Current meters measure water velocity at individual points in the vertical profile, whereas velocities that are measured by the ADCP and assigned to individual depth cells are really the center-weighted mean of velocities that are measured throughout the sample window (fig. 1.15).

Time Gating: Measuring Doppler Shifts from Different Depths

The ADCP profiling capability is accomplished by time gating (and sampling) the received echo at increasingly longer time intervals as the acoustic-beam wave fronts vertically traverse the water column (fig. 1.16).

The analogy of a Navy sonar operator can be used to understand time gating. The sonar operator presses a button on the sonar console causing a “ping” to be transmitted by the ship’s sonar transducer. As soon as the ping is transmitted, the sonar operator activates a stopwatch and begins listening to the returned echo. The sound from the ping travels through the water very

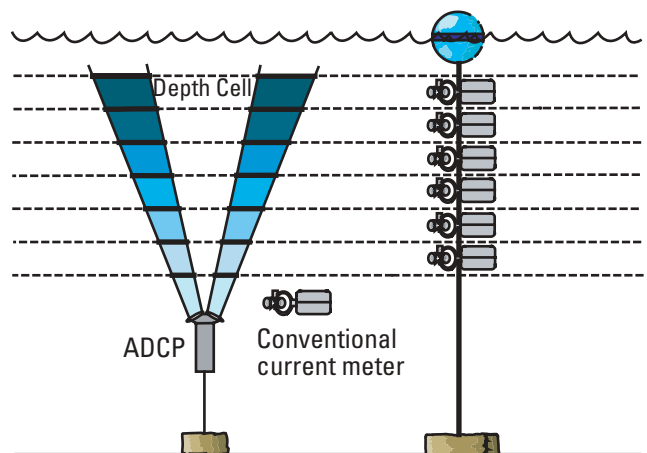

Figure 1.15. Analogy of a conventional current-meter string to an acoustic Doppler current profiler (ADCP) profile.

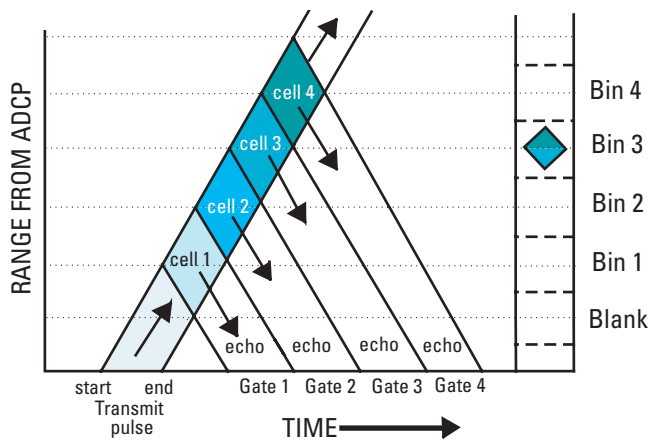

Figure 1.16. Acoustic Doppler current profiler (ADCP) time gating. Adapted from R.D. Instruments, Inc., (1989).

fast, but at a finite speed that can be calculated. The operator hears a continuous, low-intensity echo that is caused by the sound reflecting off of particles in the water as the ping speeds toward the ocean floor. The operator hears an abrupt increase in echo amplitude and frequency and immediately presses the stop button on the stopwatch. The echo anomaly was caused by a submerged submarine. The operator then calculates the distance to the submarine using the elapsed time from the stopwatch and a speed-of-sound equation (Urlick, 1975). The speed of the submarine, relative to the Navy ship, also can be calculated and is proportional to the Doppler shift of the returned echo.

If the sonar operator was replaced by a computer-controlled receiver and time circuit, the received echo could be recorded and “sliced up” into small pieces with each piece corresponding to a received time. Each slice (depth cell) would be from an increasingly deeper part of the water column. The speed of the particles in each depth cell could be measured by calculating the Doppler shift of the echo in each depth cell. For this purpose, most ADCPs contain a computer-controlled receiver and timer circuit for each acoustic beam, as well as sophisticated signal-processing hardware to calculate Doppler shifts.

The ADCP transmits a ping along each acoustic beam and then time gates the reception of the returned echo on each beam into depth cells. Speed and direction are then calculated (using a center-weighted mean of the velocities measured in the depth cell) and assigned to the center of each depth cell (bin) over the measured vertical.

Bottom Tracking

To measure absolute water velocities (water velocities relative to the Earth), the ADCP must sense and measure the velocity of the ADCP, relative to the

river bottom (bottom tracking). If the velocity of the water is known, relative to the ADCP, and the velocity of the ADCP is known, relative to the river bottom, then the water velocity, relative to the bottom, can be calculated. The bottom-track pulse is somewhat longer than the water-track pulse to properly ensoundify the bottom (fig. 1.17). All ADCP instruments that are designed to measure discharge have the ability to calculate vessel velocity using a bottom-track pulse. The bottom-track ping also is used to measure the profiled depth range from each beam. These depth-range measurements are averaged to obtain a depth for the measured velocity profile.

Acoustic Doppler Current Profiler Limitations for Velocity-Profile Measurements

Range Limitations

Reception and calculation of Doppler shift from a returned echo requires sophisticated electronic circuitry as well as high-speed digital signal-processing algorithms. The ADCP contains circuitry and micro-processors capable of resolving very small changes in echo Doppler shift that are needed for accurate water-velocity and bottom-velocity measurement. However, there are some problems associated with echo reception and water-velocity measurement using ADCPs.

In an ADCP, the backscattered echo amplitude falls off as a function of range, frequency, and pulse width, as well as the attenuating properties of the water mass. In ADCP systems, the uncertainty (random error) of the returned velocity measurement is strongly affected by changes in the backscattered echo amplitude. Figure 1.18 shows a spectrograph illustrating the relationship among transmit frequency, echo amplitude, and spectral width. For accurate water-

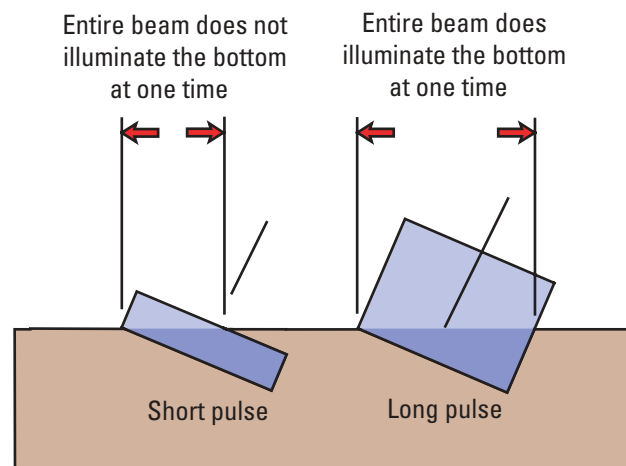

Figure 1.17. Short and long bottom-track pulse. Adapted from R.D. Instruments, Inc., (1989).

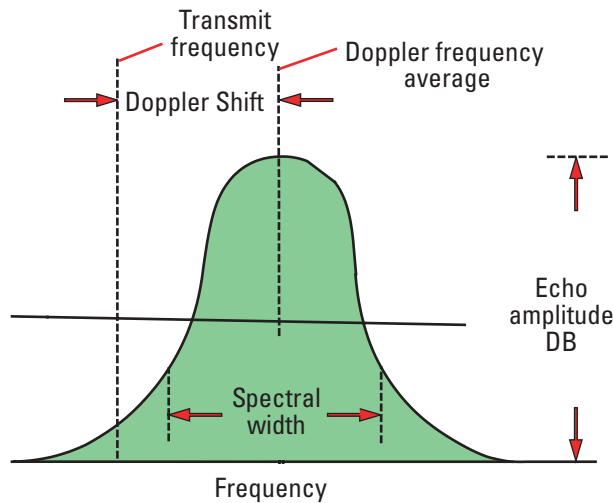

Figure 1.18. Spectrograph of received Doppler signal. DB, decibels.

velocity measurement, the returned signal should have a very small spectral width (as shown by the dotted line labelled “Doppler frequency average” in figure 1.18), but, in reality, there are several factors that “spread” or “smear” the returned frequencies over a larger part of the frequency spectrum, as bounded by the solid line in figure 1.18.

The first factor is the finite duration of the acoustic transmit pulse. If the pulse is t seconds long, the reflected signal has a frequency spread of $1/t$ Hz, about the center frequency (Urlick, 1975). This effect is the dominant source of spectral spreading of the received Doppler shifted echo. This spectral spreading causes increased random error in the determination of Doppler shift and, therefore, increased random error in the measurement of water velocity. The smaller the pulse width, the greater the amount of random error.

Figure 1.19 shows a signal being backscattered from scatterers of different sizes that are moving at different speeds, which results in the arrival of signals at differing phases. Because the autocorrelation technique needs accurate phase information to calculate frequency shift, this spreading effect causes random error in the determination of Doppler shift.

In natural waters, the reflected signal is affected significantly by scatterer velocities in the cloud of particulate matter that is “illuminated” by the ultrasonic pulse (fig. 1.20). The result of this cloud-scattering effect is to increase the spectral width of the return signal.

Although the dominant source of spectral spreading is the transmit pulse length, the measured spectral width can be an indicator of velocity uncertainty. As the signal-to-noise ratio decreases near the end of the profile, the spectral width increases. This increase translates directly into velocity uncertainty.

Thus, changes in spectral width are related to velocity uncertainty, especially in the last one-third of the profiling range (R.D. Instruments, Inc., 1989).

The echo amplitude is the measure of the energy in the echo and varies with a dynamic range of many

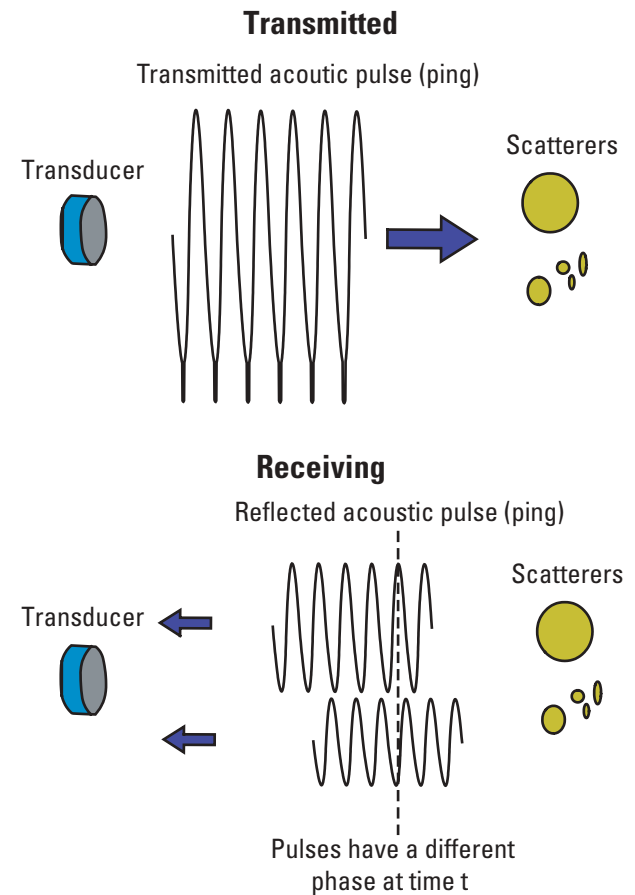

Figure 1.19. Phase change due to size and speed differences of scatterers.

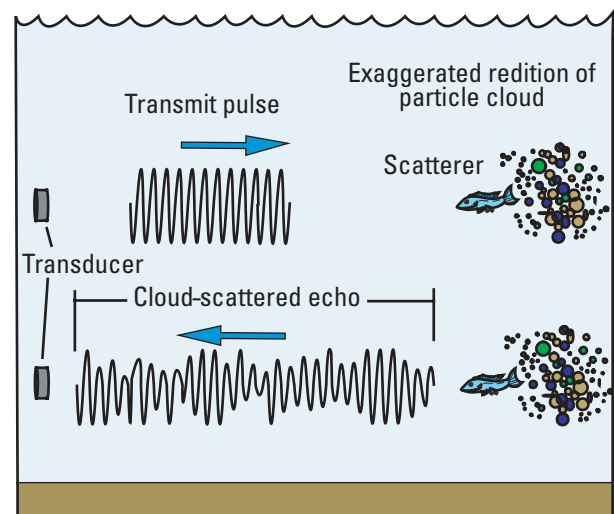

Figure 1.20. Echo returned from a cloud of particles.

orders of magnitude; therefore, it is converted to decibels. The echo amplitude is a function of several things:

- Transmit pulse power
- Transmit pulse length
- Reflective quality of scatterers
- Quantity of scatterers
- Absorption coefficient of the water

When the echo amplitude is high, the signal-to-noise ratio of the returned echo is high. However, when the echo amplitude drops below a certain level, the signal-to-noise ratio drops, increasing the spectral width, which, in turn, increases the uncertainty of the velocity measurement. This effect increases with range because the echo signal-to-noise ratio decreases with range. The signal-to-noise ratio also can decrease if there are too few particles in the water column. Ironically if there are too many particles (as with a very high sediment concentration), signal-to-noise ratio,

from the far bin, echoes can be reduced because of absorption, beam spreading, and attenuation.

Side-Lobe Interference

Most transducers that are developed using present technology have parasitic side lobes that are emitted 30–40° off the main beam acoustic beam. Side-lobe interference is caused when the parasitic side lobe of an acoustic beam strikes the bottom before the main beam finishes traversing the total depth (fig. 1.21).

When the side lobe strikes the bottom, it usually swamps the receivers with an increased amplitude signal that smears the velocity information that is being gathered from the main-beam echo. On a 1,200-kHz BB-ADCP system, the loss of vertical profiling range because of this effect is approximately 15 percent with 30°-beam angles and 6 percent with 20°-beam angles.

Figure 1.22 shows a screen shot of a typical Doppler profile showing the backscattered amplitude or, using an RDI-coined term, the “reflected signal

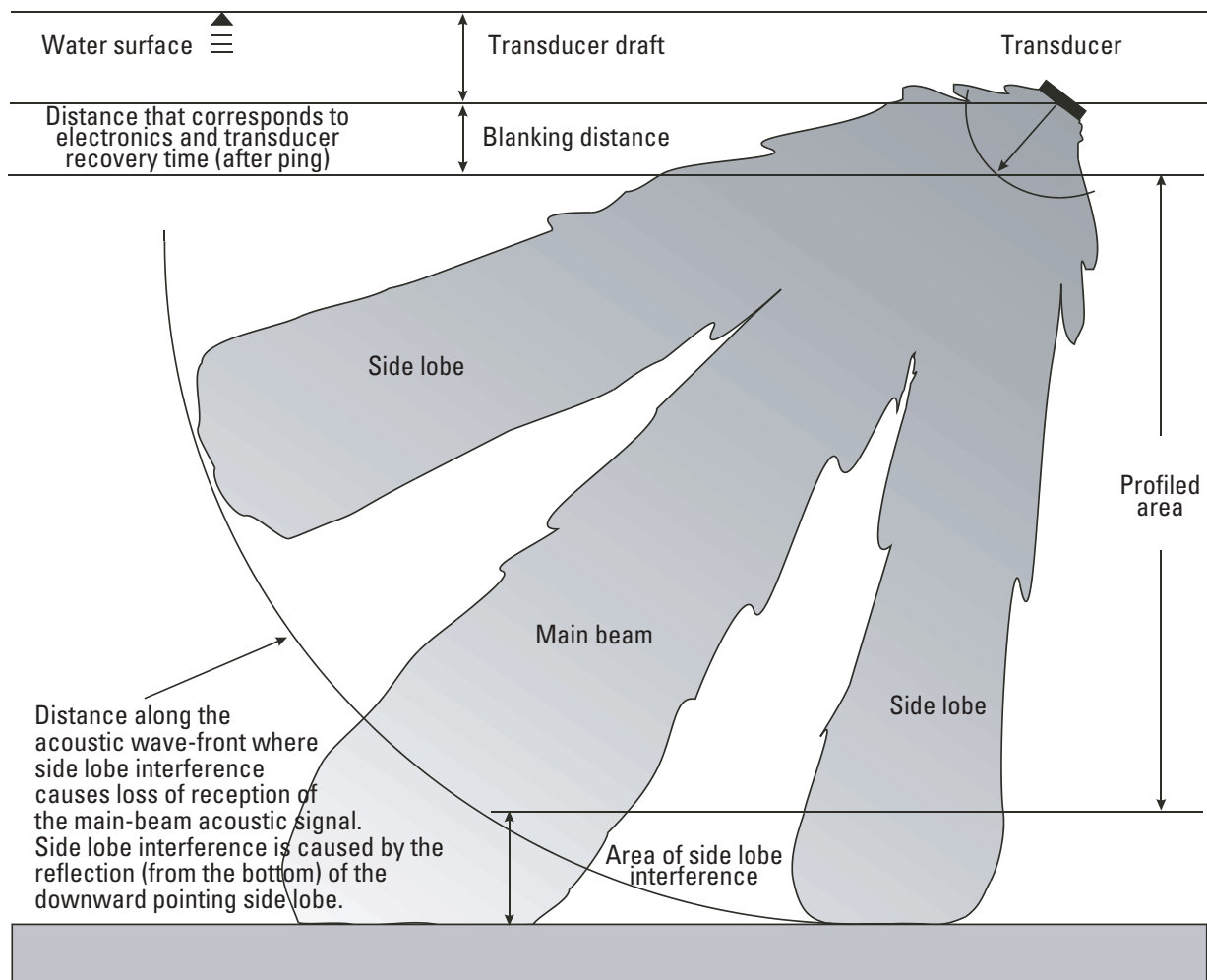

Figure 1.21. Acoustic Doppler current profiler transducer beam pattern.

Bottom Ping - RSSI

RSSI - Reflected Signal Strength Indicator



Figure 1.22. Reflected signal strength indicators (RSSI) for a four-beam acoustic Doppler current profiler.

strength indicator” (RSSI). Notice that the RSSI falls off logarithmically with depth until the side lobes strike the bottom. A sharp increase in the RSSI occurs when the side lobes hit the bottom because the bottom is such a strong reflector. Another reflection is seen below the first bottom reflection. This is called a multiple, and it occurs when the signal is reflected off the bottom, travels to the surface, and is reflected off the surface. Note that the multiple is twice the depth as the “original” bottom echo.

Effects of Different Beam Angles

Although using smaller beam angles increases the percentage of the profile that is measured, the precision of water-velocity measurements also is reduced because of decreased coupling with the horizontal. The formula for this calculation is shown in equation 1.4 (R.D. Instruments, Inc., 1989):

$$R_m = D \cos(A) \quad (1.4)$$

where

R_m = maximum measurable range, in meters;

D = distance from the ADCP to the channel bottom, in meters; and

A = angle of the beam relative to the vertical, in degrees.

The standard deviation of single-ping water-velocity measurements decreases as a function of beam-pointing angle (angle between beam and the vertical). If standard-deviation values are known for a given beam angle, they can be predicted for other beam angles using the ratio of the sines of the angles (eq. 1.5).

$$\sigma_u = \frac{\sigma_a \sin(A)}{\sin(a)} \quad (1.5)$$

where

σ_u = predicted single ping standard deviation of measured horizontal water velocity, in centimeters per second;

σ_a = single-ping standard deviation of measured horizontal water velocity, in centimeters per second, using beam angle a ;

A = beam angle a , in degrees; and

a = beam angle of predicted measurement, in degrees.

Note that σ_u approaches infinity as the beam angle approaches zero (fig. 1.9).

Blanking Distance

After transmitting acoustic pulses, the transducers and associated electronics must rest a short time before receiving the reflected acoustic signals. A good analogy of this effect is a large gong. The vibrations from a gong take a long time to die out (sometimes several minutes). A transducer ceramic is similar to a miniature gong in that the pulse (ping) vibrations at the 1,200-kHz resonant frequency must be allowed to die out before the transducer is used as a listening device. These tiny vibrations last about 170 microseconds. During that time, the acoustic pulse has traveled about 0.3 m (0.98 ft) if sound velocity is assumed to be 1,500 meters per second (m/s) [4,921 feet per second (ft/s)], and velocity measurements cannot be made within that distance (fig. 1.21).

The actual distance to the first measured bin depends on several factors:

- Blanking distance
- Speed of sound
- Operating mode
- Bin size
- Transmit frequency
- Transducer beam angles

Instrument Development: Solving the Problem of Velocity-Measurement Uncertainty

Aside from the instrument errors discussed in the previous section, most early ADCP measurement systems suffered from “sloppiness,” or in more technical terms, “velocity-measurement uncertainty.” Single-ping velocity uncertainty for an RDI narrow-band 1,200-kHz ADCP purchased in 1986 (using default settings), for example, was 13 cm/s (0.43 ft/s). Luckily this “sloppiness” is, for the most part, random and can be reduced by data averaging. “Narrow-band” is defined later in this chapter. The following section discusses the reasons for velocity-measurement uncertainty and some techniques used to reduce it.

Random and Bias Error

When using an ADCP, two types of errors contribute to velocity uncertainty; random error and bias. Bias errors are sometimes called systematic errors. Random error can be reduced by data averaging; bias error cannot. A thorough understanding of these two types of errors is a crucial prerequisite to the assessment of ADCP velocity and discharge measurement accuracy.

Random Error

ADCP sources of random error are as follows:

- Pulse length—The shorter the pulse length for a given frequency in a narrow-band ADCP, the greater the random error
- Transmit frequency—the lower the frequency at a given pulse length (or lag distance), the greater the random error
- Signal-to-noise ratio—the lower the signal-to-noise ratio, the greater the random error
- Beam angle—As the beam angle approaches vertical, random error approaches infinity

A random velocity-vector error is composed of a random magnitude and a random direction. Figure 1.23 shows 1,920 pings (individual velocity measurements) taken on a lake near Sacramento, California, using a BB-ADCP. Velocities were taken in still water from depth cell number 10 (bin 10) and averaged into 10 ping groups that gave a total of 192 velocity averages. The north and east components were averaged for 10 pings each and the resultant averages were converted to polar coordinates, then plotted. Notice that the error pattern is similar to the pattern of a shotgun blast, with the errors evenly distributed around zero. A directional bias would show as a nonuniform pattern of data points distributed along one of the directional axes.

Random error is reduced by the square root of the number of samples. When data averaging reduces random error magnitudes below the value of bias errors, further averaging becomes superfluous. Figure 1.24 shows the same set of data as in figure 1.23 averaged for about 200 pings; the same set of data yields nine averages.

Bias Error

A velocity-vector bias has a fixed magnitude and direction that either is constant or proportional to the measured velocity. Bias error is nonrandom and, therefore, cannot be reduced by data averaging. Fortunately, in most cases, bias error in ADCP-measured velocities and discharge measurements is

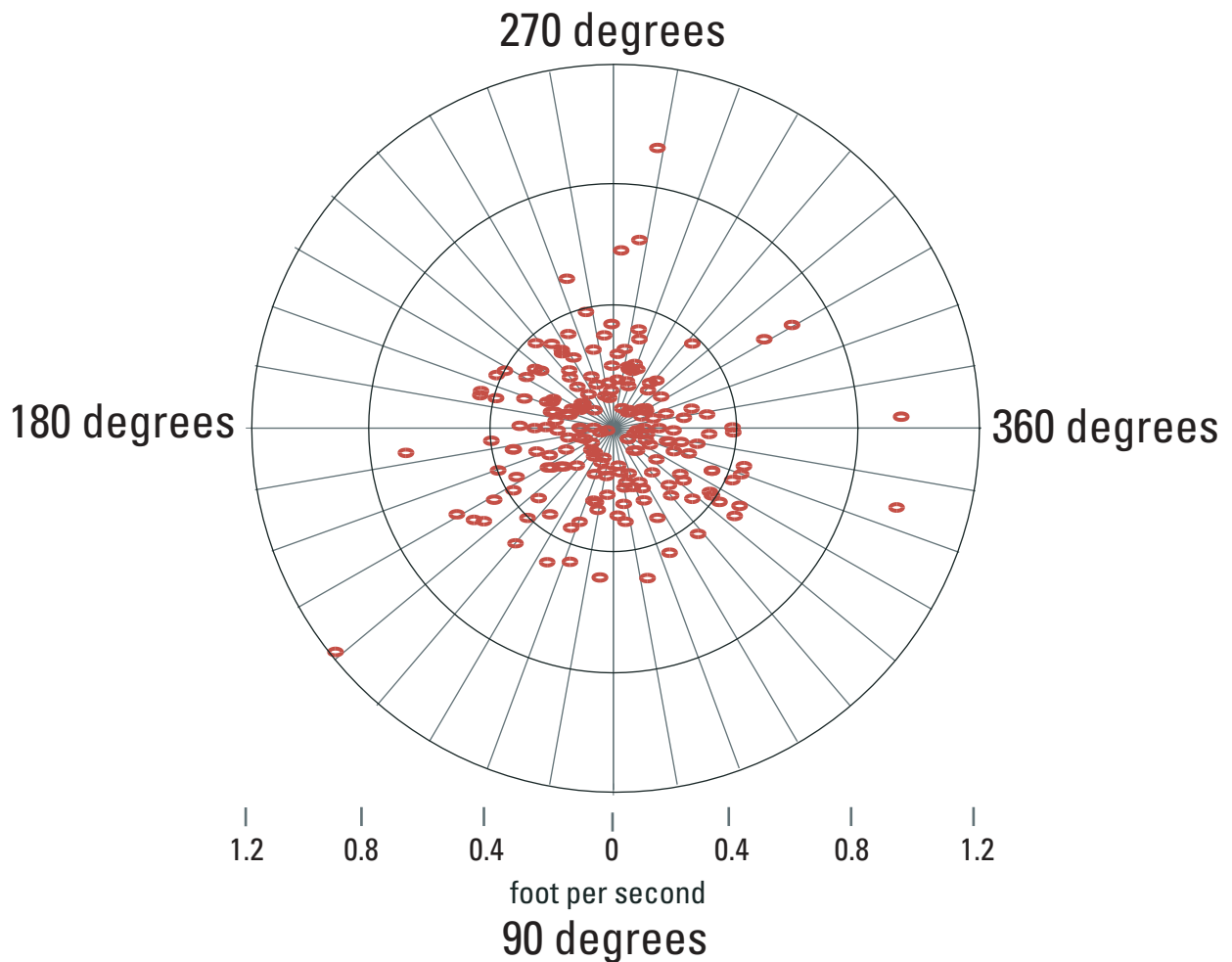

Figure 1.23. Polar plot of 10-ping broad-band acoustic Doppler current profiler velocity averages.

small. Examining figure 1.24 reveals that there may be a small bias error or an actual water velocity in the lake at a direction of 250°. Random and bias error are discussed in more detail in this report in the sections on velocity and discharge-measurement errors.

Pitch and Roll

Pitch is defined as rotation along the fore/aft axis of the ADCP, whereas roll is defined as rotation in the direction of the starboard/port axis of the ADCP. Most ADCP systems contain instruments that detect the magnitude of pitch and roll, as well as methods to correct ADCP-measured velocities for the effects of pitch and roll. Figure 1.25 shows the pitch and roll axes as they apply to a boat-mounted ADCP.

Corrections for pitch and roll of an ADCP must address velocity corrections and depth corrections. The velocity corrections are needed because the geometry

of the beam angles change, with regard to the flow field (eq. 1.3, fig. 1.8), during instances of pitch and roll.

Changes in bin depths also are evident during pitch and roll occurrences (fig. 1.26). Bottom depths and bin depths must be “remapped” during an ADCP pitch and roll occurrence. For small angles of pitch and roll, these corrections are not significant unless velocity profiles in all three orthogonal coordinates are desired. Values of horizontal water velocity are a function of the cosine of the pitch and roll, which is insignificant for angles less than 5°. However, if accurate vertical velocities are desired, even small amounts of pitch and roll can significantly affect accuracies. ADCPs commonly are designed with pendulum-type pitch and roll sensors, which are affected by acceleration. However, if an ADCP is expected to be used primarily aboard a vessel in areas having large waves, then fast-responding gyroscope systems should be used to compensate for pitch and roll.

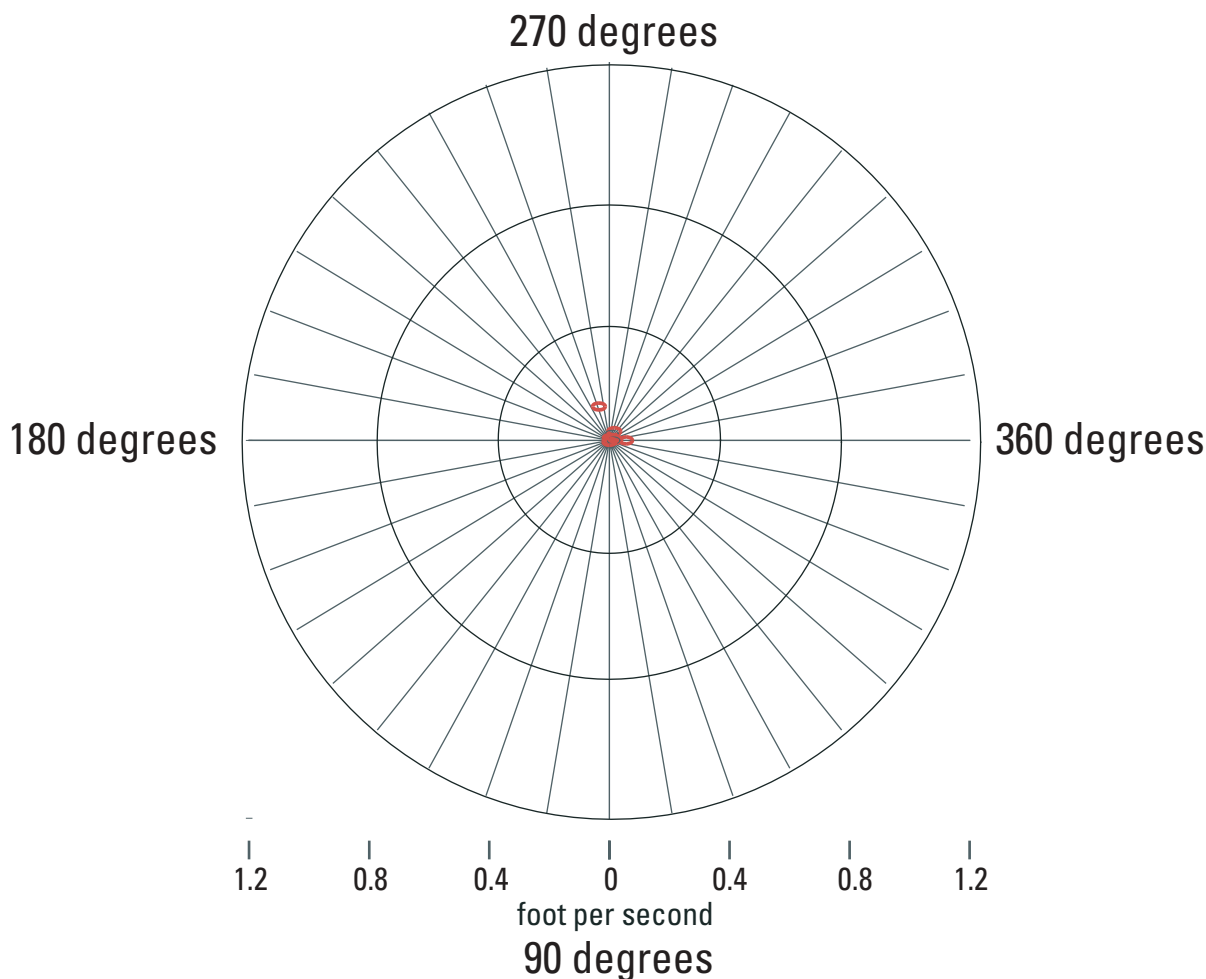

Figure 1.24. Polar plot of about 200-ping broad-band acoustic Doppler current profiler velocity averages.

Beam-Angle Error

Errors in the beam angles could have been a significant source of bias error with early ADCP systems before the manufacturer instituted quality-assurance procedures to minimize this type of error. Beam-angle errors are best detected on a fixed distance course. The manufacturer has developed a computer program that accurately calculates ADCP beam-angle errors, based on data that are collected on the fixed distance, lake, or bay course. Beam-angle errors also will show as biases during intercomparison tests with conventional discharge measurements or other discharge-measurement devices.

Beam-angle errors can be eliminated in recently developed (after 1993) ADCP firmware by introducing corrections into the ADCP system flash memory. This procedure should be done only by the manufacturer. Suspect systems should be sent to the manufacturer for beam-angle testing and recalibration.

Narrow-Band and Broad-Band Doppler Shift Measurements

“Narrow band” is not a very descriptive term and is used here only because the term is used in the industry to describe a certain type of ADCP instrument. The term is used to describe a pulse-to-pulse incoherent ADCP. This means that in a narrow-band ADCP, only one pulse is transmitted into the water, per beam per measurement (ping), and the resolution of Doppler shift must take place during the duration of the received pulse. In the case of RDI-manufactured narrow-band ADCPs, this is accomplished using an autocorrelation technique.

The broad-band (BB) ADCP was developed by RDI in an attempt to solve some of the measurement uncertainty problems seen with the narrow-band ADCP. In a BB-ADCP, the Doppler shift is resolved by transmitting two pulses of the same shape that are in phase with each other (pulse-to-pulse coherent). The following section describes, in detail, the operation of narrow-band ADCPs and BB-ADCPs.

Narrow-Band Doppler Shift Measurements

Doppler shift can be described as the perceived frequency shift of a transmitted (and then reflected) signal caused by the movement of the reflector. Doppler effect also can be described as the magnitude of the phase difference between two coherent (but independent) samples of a reflected signal. The following analogy provides an explanation of narrow-band Doppler shift velocity measurements.

Joel Gast (R.D. Instruments, Inc., oral commun., 1992) has likened a narrow-band Doppler shift measurement to the measurement of automobile speed on a freeway (at night) using a strobe light and a high-speed camera. Consider a freeway at night with traffic moving at a steady rate of speed. A camera has been placed near the freeway and posts have been installed at set distances within the camera's field of view. A strobe light is actuated and, while the freeway is illuminated by the single-strobe pulse, the camera takes two high-speed photographs. When the investigator examines the photographic negatives he finds that by lining up (synchronizing) the images of the cars on the two photographic negatives, the distance traveled by the cars can be determined by measuring the apparent shift in position of the reference posts (fig. 1.27). The auto speeds also can be calculated by multiplying intrapost distance by the lag time between the two photos. If the strobe flashes become acoustic pulses, the cars become reflective particles in the water column, and the negatives become the received

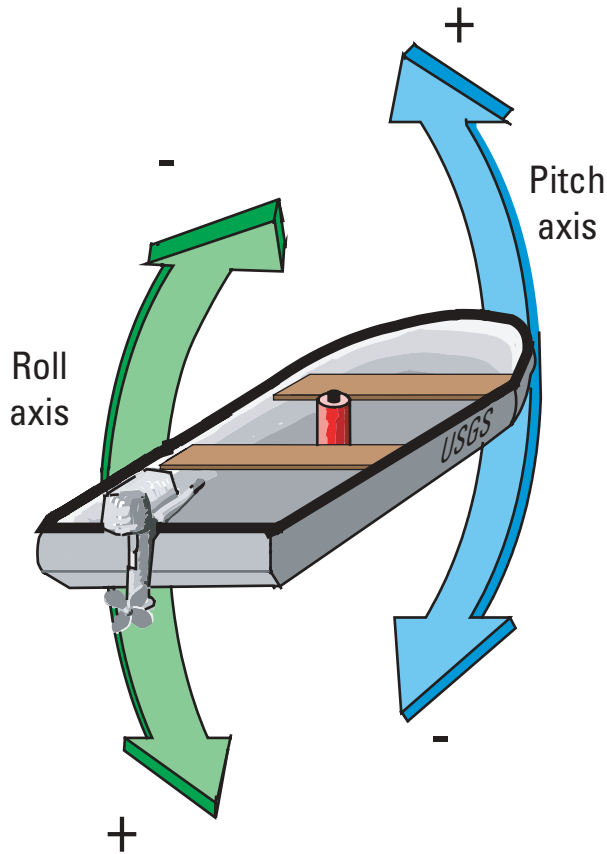

Figure 1.25. Pitch and roll axes for a boat-mounted acoustic Doppler current profiler.

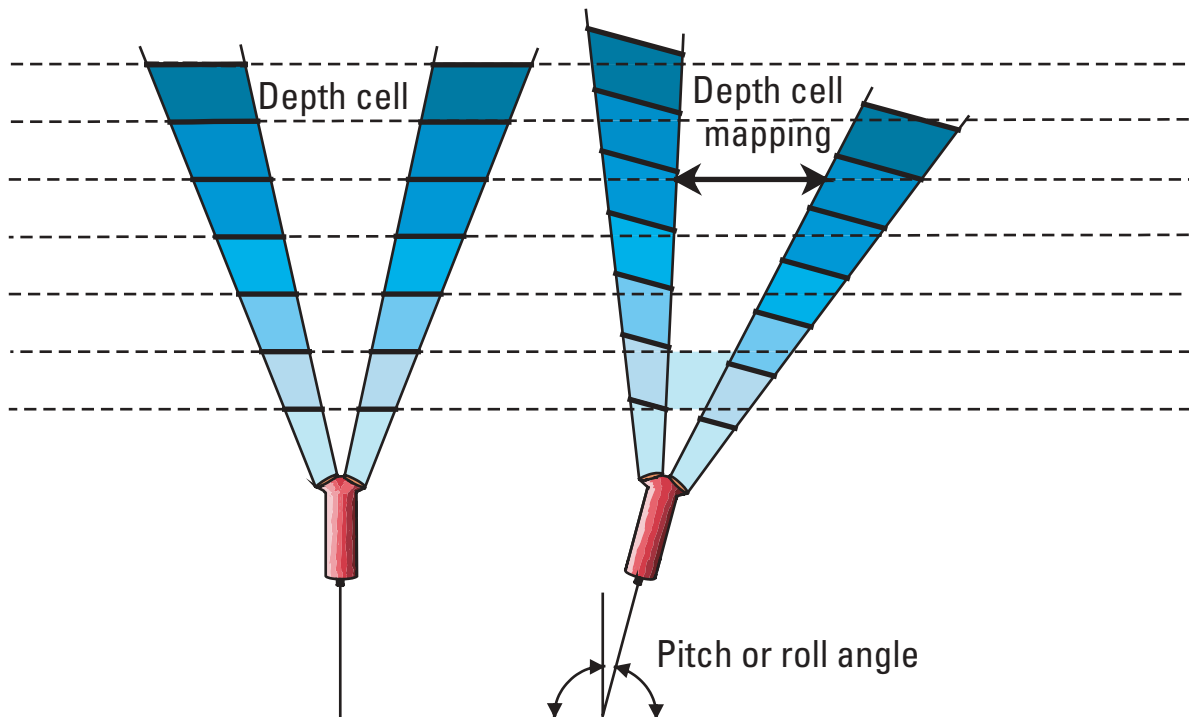

Figure 1.26. Bin positions during an acoustic Doppler current profiler roll occurrence.

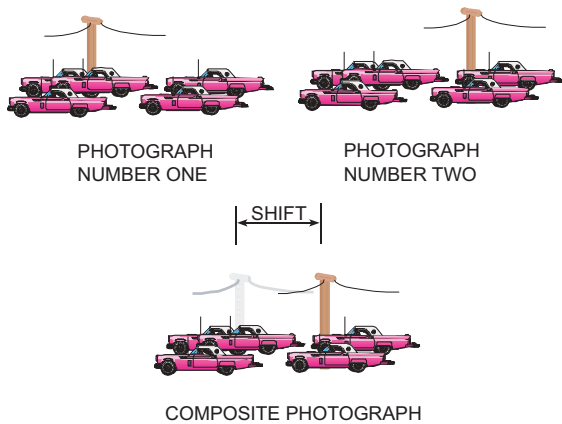

Figure 1.27. Freeway strobe-light system used to measure vehicle speed.

reflected signals, this scenario becomes roughly analogous to the workings of a narrow-band ADCP system.

The drawback to such a system is that the strobe pulse dissipates very quickly and the two photos must be taken while the same cars are still illuminated by the strobe. This means that time lags are very short and the distance traveled by the cars (reflectors) is very short; therefore, the car speeds cannot be measured precisely. Because of these limitations, velocity measurements made using the narrow-band technology are “noisy” (have a relatively high random error). Figure 1.28 shows a diagram of a narrow-band Doppler shift measurement. The signal is sampled twice during the reception of the reflected signal. The lag-time between

Narrow-band ADCP

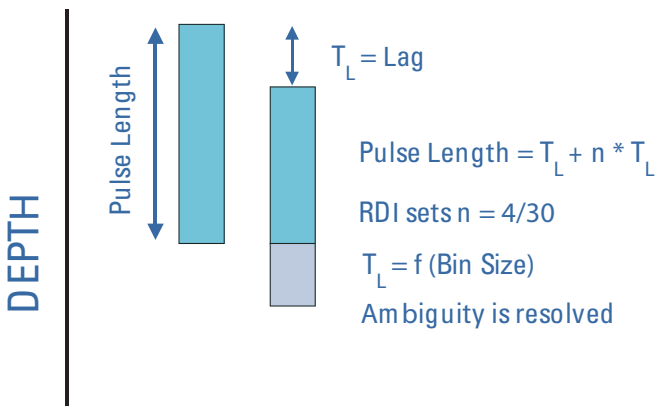

Figure 1.28. Narrow-band acoustic Doppler current profiler (ADCP) shift measurement. RDI, R.D. Instruments, Inc.

each measurements is shown as T_L . Using an auto-correlation technique, the Doppler shift is then calculated. In the narrow-band ADCP, the pulse length depends on the lag (T_L) which is a function of bin size. A filter scheme that looks at the whole returned signal is used to resolve ambiguity.

Broad-Band Doppler Shift Measurements

Using the freeway analogy, if the investigator decides to install another camera a distance of ten or more car lengths (parallel to the freeway) from the first camera, he could actuate a strobe, take a picture with the first camera, wait a short time, actuate another strobe, then take a picture with the second camera. If the strobes are timed correctly, the cars will travel from the field of view of the first camera into the field of view of the second camera during the time between photos. The investigator synchronizes the positions of the cars on the two negatives and finds that there is a much longer lag time (time between each strobe versus the time between two photos taken during the same strobe) and that the cars traveled a longer distance. The investigator then can calculate the speed of the cars with much greater precision than with the single-strobe system. The distance between the cameras and the time between each strobe must be chosen carefully. If the investigator waits too long between strobes, random movement between the cars (passing, slowing down, speeding up, and so forth) will render the two negatives “unmatchable” (uncorrelated). Transmitting a pair of pulses (strobes) into the water allows for much longer lag times (therefore, more precision) than the narrow-band system. The investigator finds, however, that there are some “costs” associated with this technique.

One of the most significant costs is self noise. The description of self noise again uses the freeway analogy. Suppose that, because of limitations in photographic technology, the freeway cameras have no shutters. Because the investigator must leave the camera shutters open, both cameras will “see” the traffic illuminated by the two strobes. However, only 50 percent of the “scenery” will be usable to both cameras for correlation purposes. For example, the film in camera one is exposed once during the first strobe. The cars then travel out of the field of view of camera one and into the field of view of camera two. However, the film in camera two already has been exposed by the flash of the first strobe and, thus, any cars photographed have left the field of vision. When the second strobe flashes, the film in both cameras is again exposed (double exposed) and the cars that were first photographed by camera one are now photographed by camera two. Because the film has been double exposed, only 50 percent of the scenery in each exposure contains cars that are common to both cameras.

As in the film of the freeway cameras, the reflected wave front from the first BB-ADCP pulse-pair is again “exposed” by the incident wave front of the second pulse and, therefore, is subject to the same “double exposure.” The increased noise due to this 50-percent correlation is reduced by data averaging (very narrow pulses can be used, and, therefore, large amounts of data can be collected and averaged). Without a technique called phase coding (discussed later in this section) and a high signal-processing rate, BB-ADCP velocity measurements would be less precise (because of self noise) than measurements made by the narrow-band ADCP system.

The BB-ADCP cannot only measure the phase angle differences between pulse pairs, but can measure the change in lag spacing between transmitted and received pulse pairs (time dilation). This pulse-pair measurement concept can be visualized using a series of illustrations depicting a stationary particle, a moving particle, and the effects of these particles on lag times between reflected pulse pairs in a liquid medium. Figure 1.29 shows a transmitted pulse pair from a stationary source approaching a stationary particle.

Figure 1.30 shows the same pulse pair reflected from a stationary particle. In the case of a stationary particle, lag A (fig. 1.29) is equal to lag B (fig. 1.30). Now assume that the particle is moving away from the transducer. Figure 1.31 shows the aforementioned transmitted pulse pair approaching a moving particle. Figure 1.32 shows the pulse pair after their reflection from the moving particle.

Note that, in the case of a moving particle, the reflected pulse lag distance (lag B) has increased because the particle’s movement delays the reflection of the second pulse, relative to the first. Although this

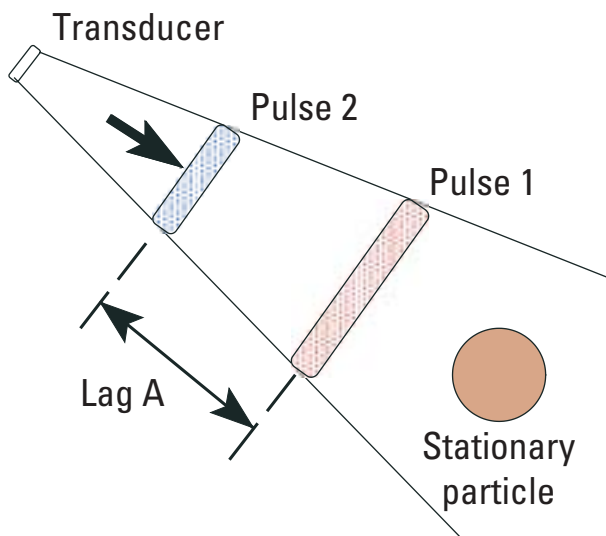

Figure 1.29. Acoustic pulse pair approaching a stationary particle.

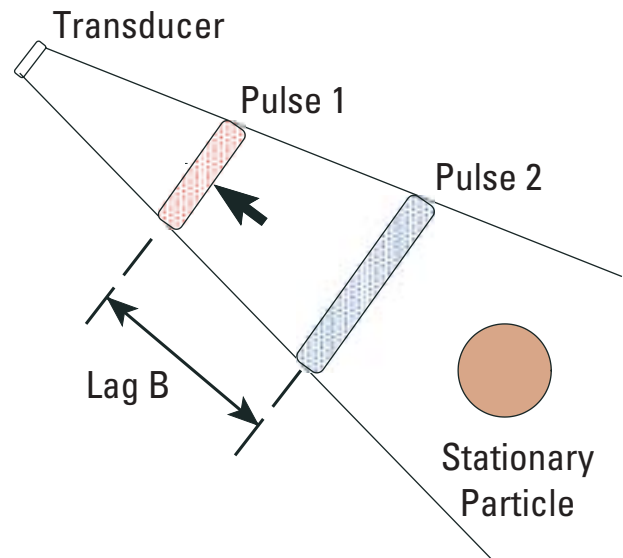

Figure 1.30. Acoustic pulse pair reflected from a stationary particle.

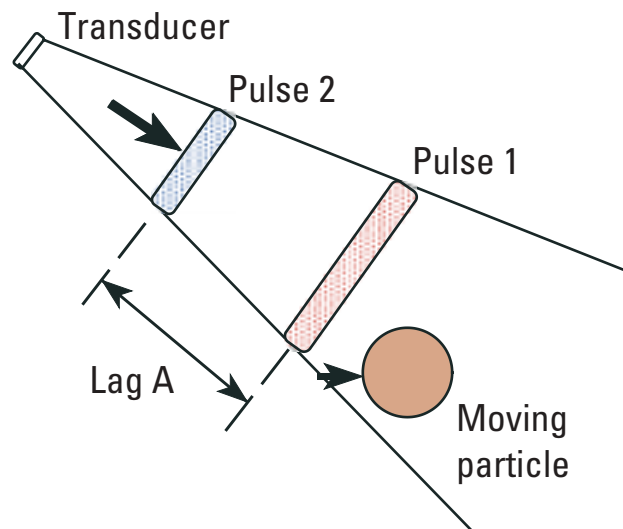

Figure 1.31. Acoustic pulse pair approaching a moving particle.

can be thought of as a time-domain phenomena, it is really a description of Doppler effect. The transmitted pulse repetition frequencies appear to vary in accordance with changes in the speed and direction of the transducer and (or) reflector.

Lag distance between the reflected pulses increases as the transducer and particle move apart. The opposite occurs if the particle and transducer move together. The difference between transmitted and received lag distance is proportional to the speed of the particle (relative to the transducer) or the transducer (relative to the particle). The difference in lag distance is exaggerated in these examples to aid comprehension. In reality, the ratio of the sound speed in water

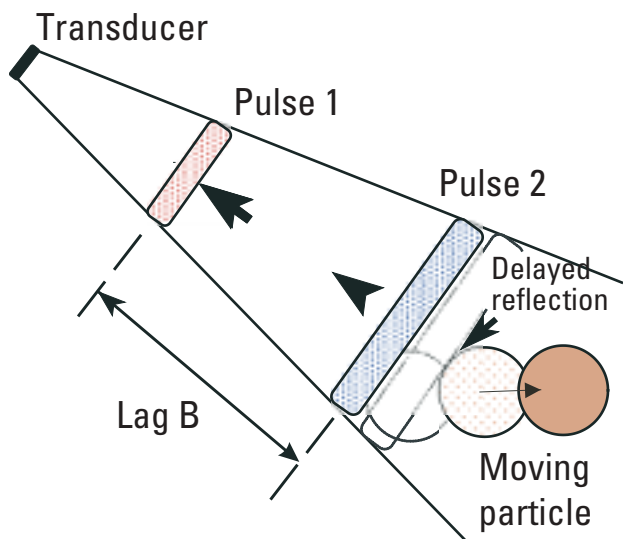

Figure 1.32. Acoustic pulse pair reflected from a moving particle.

[1,500 m/s (4,921 ft/s)] to the particle speed [0–2 m/s (0–6.6 ft/s)] results in very small lag differences. If a particle is moving slowly, the lag differences will be small and hard to measure. For that reason, discharge measurements of flows with low water velocities (0.05 m/s or less) are imprecise using the BB-ADCP discharge-measurement system unless special methods are employed. The accurate measurement of these lag differences is discussed in the next section.

Self noise can be visualized as shown in figure 1.33. When pulse “a” illuminates an object, a small pressure wave is reflected back toward the transducer. This pressure wave contains pure information about the speed of the object that caused the reflection. The passage of pulse “b” through the reflected pressure wave again illuminates scatterers in the vicinity of the pressure wave and contaminates the pure speed information of the pressure wave with unwanted noise. This contamination causes a dramatic increase in the single-ping random error of the velocity determination.

Another cost for using the increased lag spacing available with the BB-ADCP system is velocity ambiguity. The freeway analogy is not appropriate to explain the velocity ambiguity phenomenon, therefore, a circular racetrack analogy is used (figs. 1.34a, b). Suppose the investigator decides to mount cameras and strobe systems in a helicopter that hovers above a circular racetrack at night. Both cameras are mounted so that the racetrack is within their field of view. The circumference of the racetrack has been estimated and some reference poles (visible around the edge of the track) have been identified. The investigator tests the strobe and finds that just the outlines of the cars can be

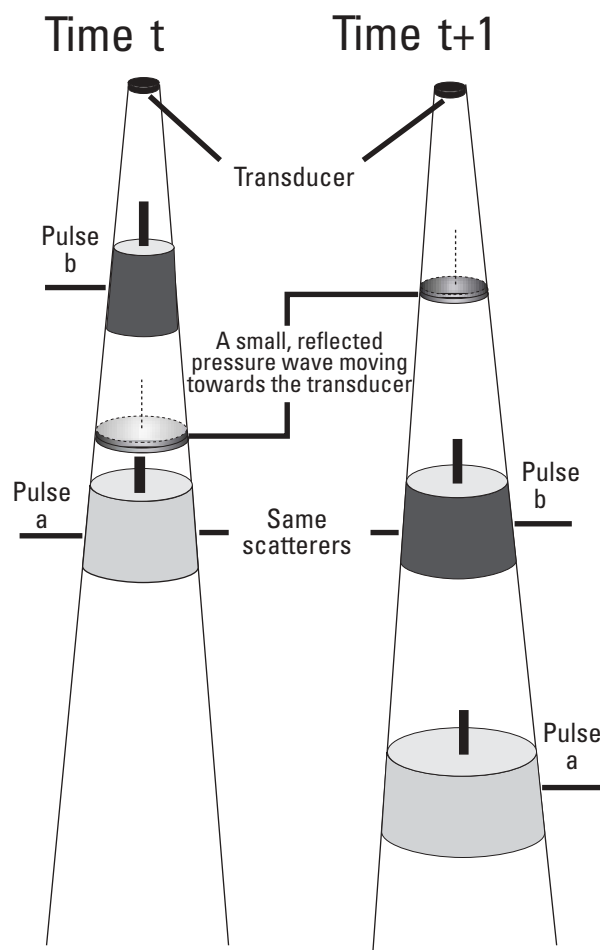

Figure 1.33. Acoustic pulse pair with a small reflected pressure wave.

seen. The camera shutter is opened, and the first of two strobe flashes is actuated. After a short time, the other flash is actuated. The investigator rotates the developed negatives to synchronize the car outlines and estimates their speed by multiplying the distance between the poles by the time between strobe flashes.

This speed-measurement system works well until the car speeds increase substantially or the investigator decides to increase the time between strobe flashes (lag times) to improve measurement precision. After the first strobe flash, the cars complete one lap (past the spot where they were first photographed) before the second strobe flash. When the investigator attempts to synchronize the negatives, he becomes confused because he cannot determine how many (if any) laps the cars have completed or whether the cars have gone forward or backward.

The “ambiguity velocity” is the velocity the cars must achieve before this confusing circumstance happens. If the strobe flashes are temporally close, the ambiguity velocity is high (higher than the cars

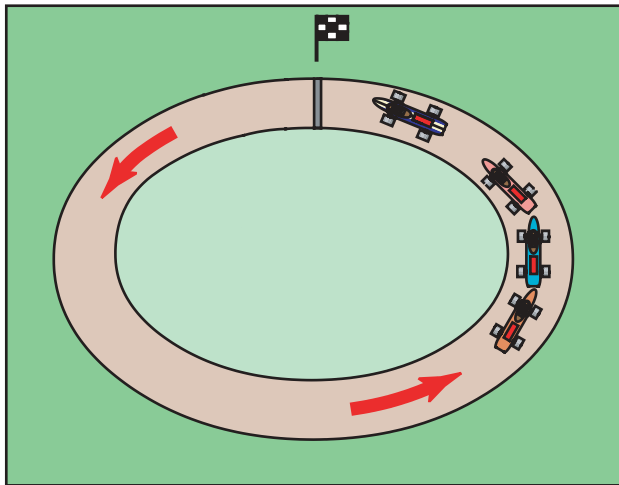

Figure 1.34a. Race track analogy during the first strobe flash.

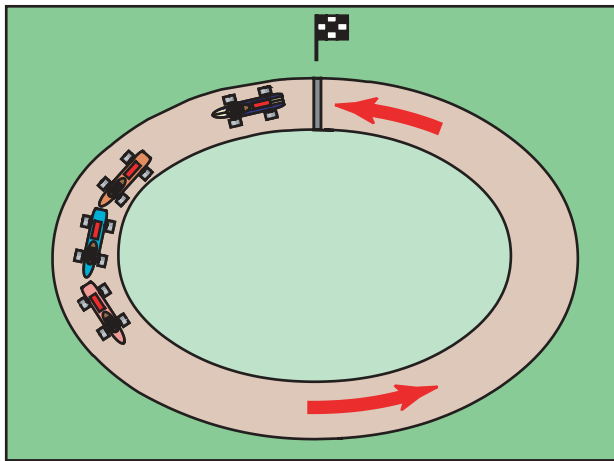

Figure 1.34b. Race track analogy during the second strobe flash.

normally travel) but measurement precision is lower because the cars have traveled a shorter distance between strobe flashes. If the investigator lengthens the time between strobe flashes (lag) to improve the measurement precision, the ambiguity velocity becomes lower and, therefore, more troublesome.

The primary method of measurement used by BB-ADCP systems is the measurement of phase-angle differences between the pulse pairs. This measurement is subject to ambiguity errors because the yardstick used to make these measurements actually is one-half of one cycle at the transmitted frequency. Figure 1.35 shows the error factor when the speed of the measured velocity exceeds the ambiguity velocity. The colored circle represents one cycle of transmitted energy with a possible phase measurement capability of 0–360°. In this example, we will let 1 millimeter per second (mm/s) equal 1° of phase change. We have no trouble

measuring plus and minus 10 mm/s or even plus and minus 170 mm/s using our one-half cycle yardstick, but when the measured velocity is 190 mm/s, our yardstick reads a velocity of –170 mm/s. This is an error of 360 mm/s. Notice that this ambiguity velocity is 180 mm/s and is equivalent to 180° on our circular yardstick. The measurement error (when the ambiguity velocity is exceeded) is always equal to two times the ambiguity velocity.

The BB-ADCP (and even the narrow-band ADCP) may report an erroneous velocity caused by ambiguity when scatterer velocities are high enough that their movement between lags exceeds one-half of the transmitted frequency wavelength. Because a 1,200-kHz BB-ADCP uses the change in phase of a 1,200-kHz sinusoid for a Doppler shift “ruler,” it is impossible to identify which cycle of the reference signal to use when calculating the phase shift between the two returned reflections when the reflected signal phase shift is greater than one-half of one wave length. To solve this problem, the manufacturer has included a signal processing technique that corrects for ambiguity errors. This technique takes additional time, however, and somewhat slows the water ping rate. Shortening the lag distance increases the ambiguity velocity, causing it to be more noticeable and less bothersome, especially if water and bottom velocities are significantly lower than the ambiguity velocity. However, decreasing the lag distance also increases noise (standard deviation of measured velocities).

The ambiguity velocity of a 1,200-kHz BB-ADCP can be estimated by equation 1.6 (L.Gordon, R.D. Instruments, Inc., written commun., 1992):

$$U_a = \frac{47}{L} \quad (1.6)$$

where

U_a = the ambiguity velocity, in meters per second; and

L = the lag specified by the BB-ADCP “&L” command.

The maximum allowed ambiguity velocity is 5.2 m/s (17 ft/s) ($L = 9$) for a 1,200-kHz system. Contamination of the measured data shows up as velocity spikes at the ambiguity interval (twice the ambiguity velocity). This means that if ambiguity errors are suspected, the (unaveraged) data should be examined for velocity spikes of the opposite sign that, when compared with the last good measured velocity, have a difference of about twice the ambiguity velocity.

Ambiguity Velocity

Example: $180 \text{ mm/s} = 180 \text{ degree phase change}$

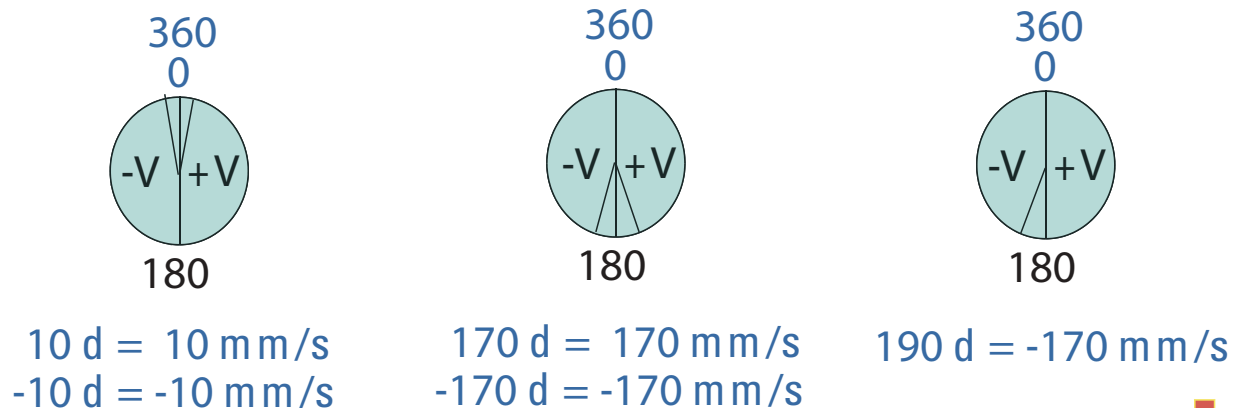

Expected = 190, measured = -170, result = 360 mm/s error
An ambiguity error will be 2 multiplied by ambiguity velocity

Figure 1.35. Explanation of ambiguity velocity. mm/s, millimeter per second; V, velocity; d, degree.

Differences Between Phase-Shift Measurements and Lag-Spacing Measurements (Time Dilation)

An unambiguous measurement can be obtained from the returned Doppler information by looking at the change in lag spacing (figs. 1.31, 1.32) but this method of measuring time dilation is much less precise than the measurement of phase-angle difference. Figure 1.36 shows the differences between phase angle and time dilation. Note that even though the ambiguity velocity has been exceeded in the last example, the time-dilation measurement still provides a “ball-park” measurement of velocity. The time-dilation method usually is used to resolve ambiguities.

Bottom-Tracking Limitations

To measure discharge, the ADCP must sense and measure the velocity of the ADCP, relative to the river bottom (bottom tracking). If the velocity of the water is known, relative to the ADCP, and the velocity of the ADCP is known, relative to the river bottom, then the water velocity, relative to the bottom, can be calculated. The bottom-track pulse must be somewhat longer than

the water-track pulse to properly illuminate the bottom (fig. 1.17). In many cases, a group of water-velocity pings is averaged along with one or more bottom-track pings to form an averaged ensemble. To compute discharge, the ADCP must provide the horizontal water and boat velocity components, depth, and time between ensembles. The ADCP discharge-measurement software discussed in chapter 2 uses these data to calculate a vector cross product at each bin and then uses an extrapolation scheme to estimate the cross products in the unmeasured areas near the top and bottom of the profile (eq. 2.2, chap. 2).

The discharge-measurement software then integrates these cross products over the profile depth to obtain a mean, depth-weighted cross product for each ensemble. The depth-weighted cross products are summed during the cross-section traverse to produce the discharge measurement (eq. 2.2, chap. 2). Bottom tracking is required by the discharge-measurement software to compute discharge. If the river bed is moving, or if the bottom-track velocities are affected by material moving near the bottom, then the cross product will be biased. This problem sometimes can be

Phase Angle and Time Dilation

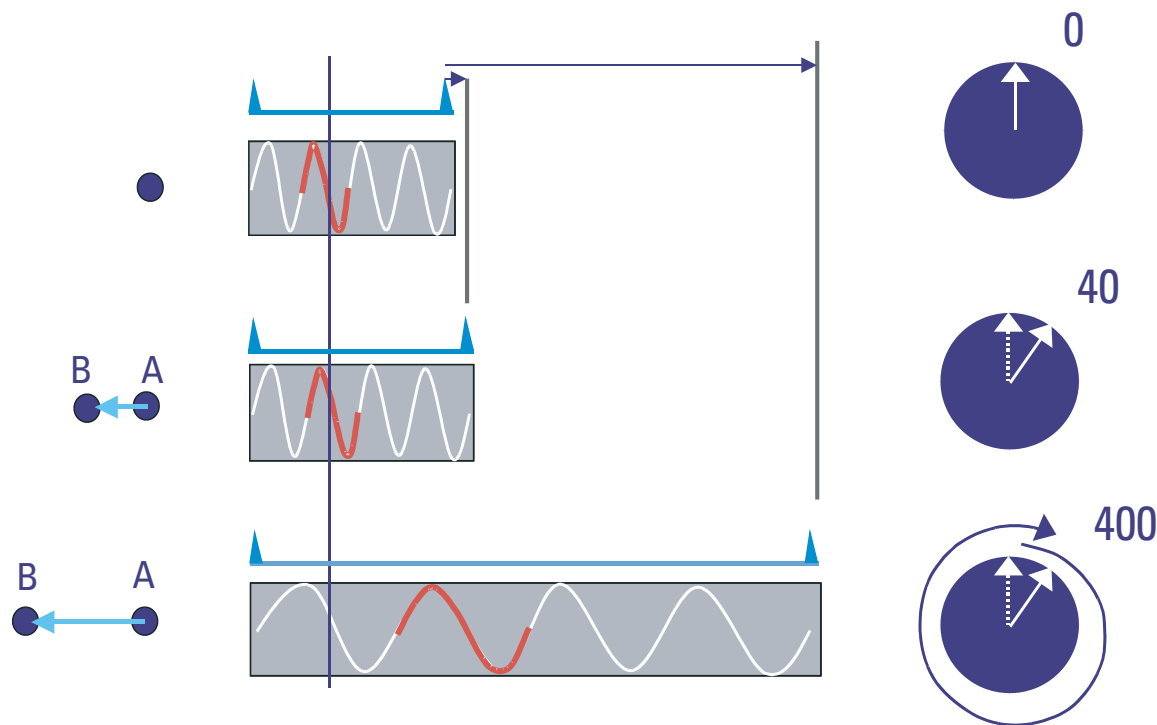

Figure 1.36. Description of time dilation compared with phase-angle difference.

alleviated by shortening the bottom-track pulse length (as shown in fig. 1.37) using the “&R” direct command as discussed in chapter 5. If shortening the pulse width does not work and if the river bed is moving at a speed of more than a few centimeters per minute, this bottom-track error cannot be eliminated and other means must be used to determine boat velocity (chap. 8).

The Broad-Band Acoustic Doppler Current Profiler: Overcoming the Self-Noise Problem

Error Sources Unique to Broad-Band Acoustic Doppler Current Profilers

In the previous section we discussed general ADCP errors. To enable a more complete understanding of the broad-band technology, we will touch upon those error sources again showing their effects on BB-ADCP systems. Although many sources of error for narrow-band ADCP systems have been discussed by Hansen (1986), Theriault (1986), Chereskin and others (1989), and Simpson and Oltmann (1993), few investigators have identified and itemized the error sources that can degrade accuracy

and precision of the more recent BB-ADCP technology. Some of the known sources of error that affect the accuracy of velocity measurements (and, therefore, discharge measurements) and errors due to the physical limitations of the system are listed in this section. The signal processing technology required to accomplish water-velocity measurements with the BB-ADCP is extremely complex; the manufacturer and users will undoubtedly find new error sources during operational use of the BB-ADCP system. Major error sources in the narrow-band ADCP systems were identified over a period of 5 years (1986–91), and it is possible that the same length of time will be required to fully understand the sources of error in the BB-ADCP system, as well.

Errors that affect the performance of BB-ADCPs for velocity measurements (and, therefore, discharge measurements) can be either random or bias. As discussed earlier in this chapter, random errors can be reduced by data averaging; bias errors cannot. For purposes of this report, random errors are assumed to be Gaussian (normally distributed about the mean) and are expressed as standard deviations (in percent) of the measured mean quantity. Bias errors have sign and

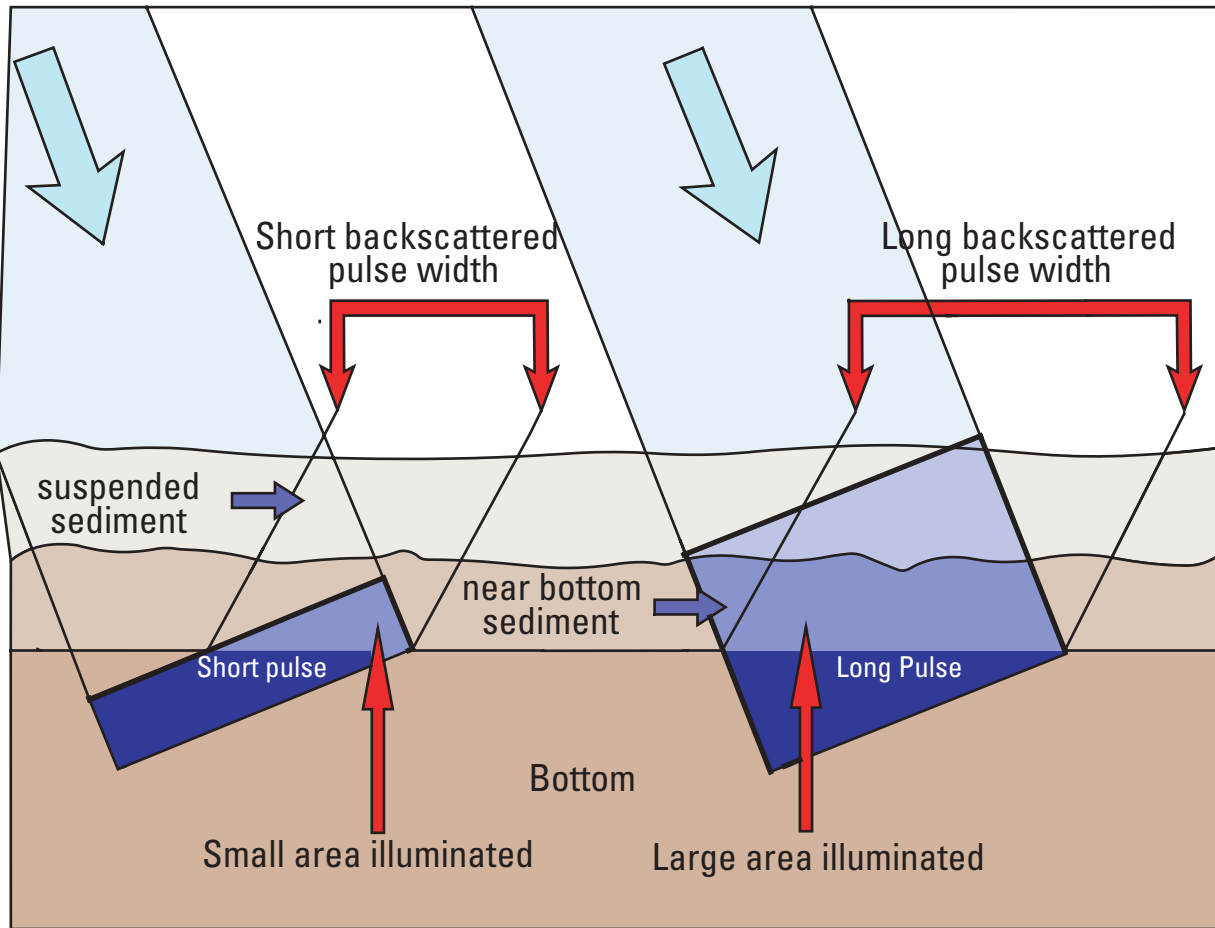

Figure 1.37. Effect of bottom-track pulse width on bias caused by bottom movement.

magnitude and are expressed as a percent of the “true” mean quantity, where “true” is defined as unbiased.

This report will not attempt a complete discussion of BB-ADCP bias error sources related to the physics of the acoustic signal (other than beam-angle errors and depth-measurement errors) because many of these sources are not yet documented and are beyond the scope of this report. Bias errors for the narrow-band ADCP system (with some application to the BB-ADCP system) are discussed in Simpson and Oltmann (1993). The most overwhelming source of velocity-measurement error in the BB-ADCP is random uncertainty due to self noise.

Random Uncertainty Caused by Self Noise

Whenever a pair of pulses is used to measure water velocity (using lag times associated with the BB-ADCP), only a 50-percent correlation can be obtained from the scenery illuminated by the pulse pair when attempts are made to synchronize (autocorrelate) the reflected signals (as discussed earlier in this

chapter). Figure 1.33 shows an acoustic beam with a pair of long acoustic pulses being transmitted into the water (pulse “a” and pulse “b”). Directly after the transmission of the pulse pair, the receiver begins “listening” to the pressure waves that have been reflected from scatterers in the water column. At time t , the reflected signals from scatterers in the water mass, illuminated by pulse a, begin their return path toward the transducers in the form of a small pressure wave. The small pressure wave advances toward the transducer for a short time before it is illuminated by pulse b traveling in the opposite direction. The passage of pulse b causes instantaneous reflected signals to be superimposed on the original reflected signals in the small pressure wave, creating a “double exposure.” This is the 50-percent decorrelation effect caused by self noise (discussed above). The reflected signals (actually a continuum of reflected signals) travel back to the transducer. These signals are received and shunted to a delay-line register (or scratch-pad memory) for a short time while the BB-ADCP signal processor applies an autocorrelation technique to the received signals in an

attempt to synchronize (match) reflections obtained from the same water mass (data separated by the time between t and $t + 1$, as shown in fig. 1.33). If the lag is matched correctly, the autocorrelation function of the reflected signals will reach a peak. Because the two pulses were transmitted coherently (with the same phase), amplitude and phase information can be calculated from the function output. By using the phase information, the speed of the reflective particles can be determined, however, measurement precision is limited because of self noise.

Suppose very narrow (short) pulses are transmitted at a and b (fig. 1.38). These pulses are so narrow that 100 of them can be placed into the space occupied by the original long pulses. This modification will increase measurement precision by the square root of the number of samples (in the case of 100 samples, by a factor of 10). With this increased precision (even with the 50-percent level of self noise), the BB-ADCP capabilities surpass those of the narrow-band ADCP by almost one order of magnitude. This increased precision is gained at great cost because of the limited amount of energy the narrow pulses can deliver into the water. This energy loss caused by the narrow pulses is so great that it renders the system nearly unusable. To overcome this energy loss, the manufacturer developed a design innovation that incorporates most of the advantages of wide and narrow pulses. A wide pulse is transmitted (therefore, delivering more energy into the

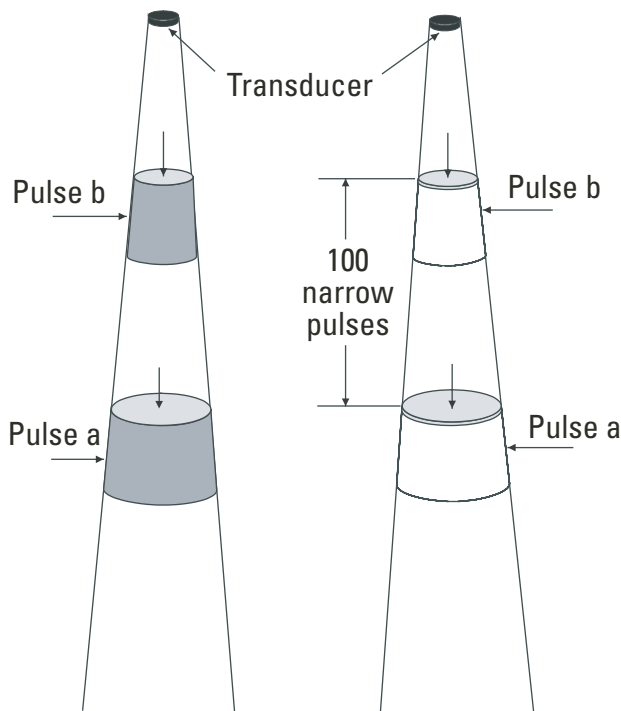

Figure 1.38. Narrow pulse pairs compared with wide pulse pairs.

water than a narrow pulse), but is logically split into many small segments called code elements, each having a phase shift of either 0° or 180° (fig. 1.39).

The coding order of these phase shifts is pseudo random (behaves numerically like a random sequence). This technique has previously been applied to radar signals and some spread-spectrum communications signals (Minkoff, 1992), but the BB-ADCP manufacturer probably is the first to use this technique for water-velocity-measurement sonar.

The consequence of transmitting this phase-coded pulse-pair series into the water is that even though the pulses are long, the signal processor still must wait the full lag period (a to b) before achieving an autocorrelation peak of significant amplitude (fig. 1.40). In other words, because of the phase coding, it is difficult for the autocorrelation algorithm to realize a peak at the wrong interval.

The objective of the manufacturer is to achieve decorrelation of adjacent pulse pairs and, therefore, a

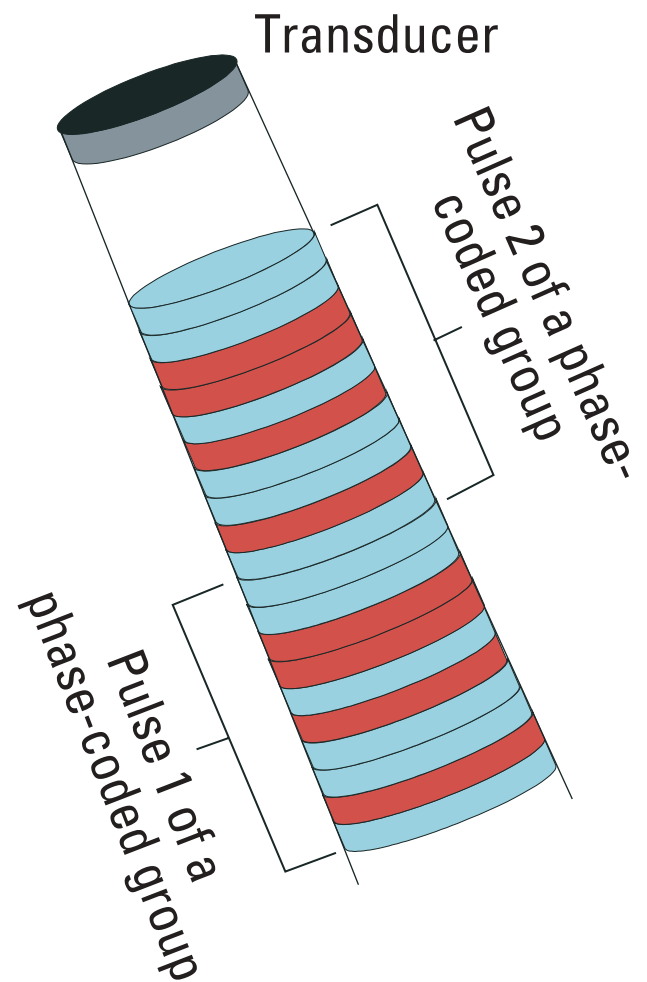
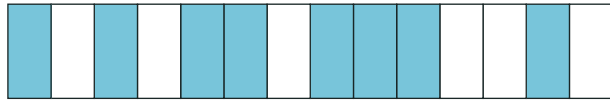
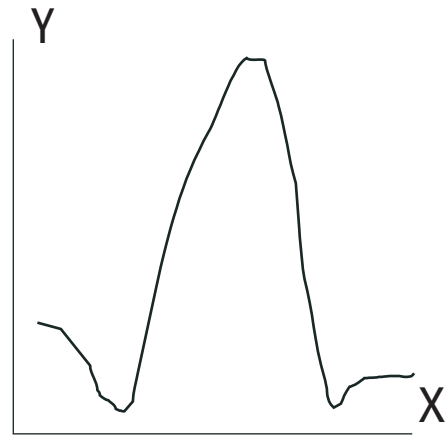

Figure 1.39. Phase-coded pulse pair.



Contents of a delay line register with matching code element spacing

=



Autocorrelation function output

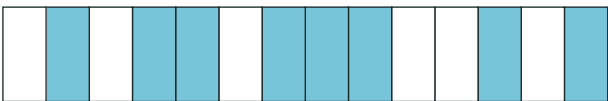
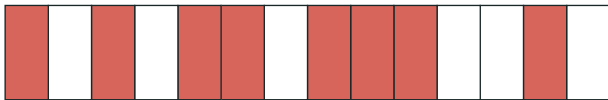

Contents of a delay line register with a delay difference of one code element

=

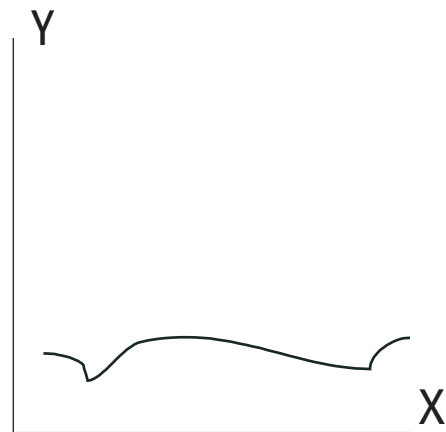

Autocorrelation function output

Figure 1.40. Effects of code element lag on correlation.

greater effective N (number of samples used for data averaging). Effective N as opposed to actual N is discussed in chapter 9. Obviously, there are times when accidental correlation occurs because currently there are only two phase choices, but, overall, a much greater precision is achieved using phase coding (because of improved signal-to-noise ratio) than by simply using a narrow pulse pair. The principle reason the manufacturers named the ADCP “broad-band” was that its bandwidth was increased to accommodate the signal processing of narrow-pulse pair (coded or not). The

amount of random uncertainty in velocity measurements due to self noise has not been formally presented by the BB-ADCP manufacturer, but presumably is contained in the performance data for overall system random uncertainty (noise) values predicted by the manufacturer's error model and presented later in this chapter. When a phase coding method is used to reduce random uncertainty due to self noise, its effectiveness is greatly dependent on the order and number of the pseudo-random code elements used to construct the measurement pulse pair.

Table 1.1. Comparison of narrow-band and broad-band single-ping standard deviation

[m, meter; ft, foot; cm/s, centimeter per second; ft/s, foot per second]

Property	Narrow-band	Broad-band
Single-ping standard deviation.....	13.5 cm/s (0.44 ft/s)	6.4 cm/s (0.21 ft/s)
Minimum bin size	1. m (3.3 ft)	.25 m (.82 ft)
Pings per second	8	2
Standard deviation of a 5-second average.....	2.1 cm/s (.07 ft/s)	1.81 cm/s (.06 ft/s)

The single-ping random error of a narrow-band ADCP is significantly higher than a BB-ADCP for a given operating frequency and bin size. However, the signal processing requirements of the BB-ADCP system are much greater than those of the narrow-band ADCP, slowing the ping rate markedly. The ping rate of a narrow-band ADCP system can be as high as 10 pings per second (or higher, depending on depth and transducer frequency), whereas the maximum ping rate of a BB-ADCP system is less than three pings per second (using present technology). Table 1.1 is an example of the net result of these effects (for 30° beam-angle systems).

The narrow-band ADCP has a 5-second average standard deviation that is comparable to the BB-ADCP if the BB-ADCP bin size is one-fourth that of the narrow-band ADCP. This means that the BB-ADCP has a higher resolution and a smaller bin size, and can be used in shallower water than the narrow-band ADCP system for a given operating frequency.

Future systems using the narrow-band ADCP technology should not be ruled out. If an adaptive scheme were used to increase the narrow-band ADCP ping rate and reduce the narrow-band ADCP bin size in shallow water, discharge measurements using either system would have comparable accuracies. Because of larger, more energetic pulses, the narrow-band ADCP system also has a slightly greater range for a given frequency than the BB-ADCP system, as well as a more robust bottom-tracking ability.

Summary

Narrow-band acoustic Doppler current profilers (ADCPs) and broad-band acoustic Doppler current profilers (BB-ADCPs) use the Doppler principle to measure profiles of water velocity. To measure discharge, they also must measure velocity of the ADCP, relative to the river or estuary bottom.

Narrow-band ADCPs use a measurement method called pulse-to-pulse incoherent velocity measurement, which means that the ADCP transmits single, independent acoustic pulses from each beam and resolves the Doppler frequency shift during the duration of a single pulse. The frequency determination method usually is an autocorrelation technique.

BB-ADCPs use two or more coherent (synchronized) acoustic pulses in a scheme called the pulse-to-pulse coherent method. The frequency determination method usually is an autocorrelation technique that measures the phase angle difference and the time difference (spacing) between the transmitted and received pulse pairs to determine Doppler shift.

The single-ping random error of a narrow-band ADCP is significantly higher than a BB-ADCP for a given operating frequency and bin size, however, the signal processing requirements of the BB-ADCP system are much greater than those of the narrow-band ADCP, slowing the ping-rate markedly.

Increasing the lag distance between the pulse pairs in a BB-ADCP system lowers the single-ping standard deviation (to a point). Longer lag times increase the chances of ambiguity errors and should be used with caution, especially when averaging data.

CHAPTER 2: ACOUSTIC DOPPLER CURRENT PROFILER DISCHARGE-MEASUREMENT PRINCIPLES

In chapter 1, narrow-band ADCP and BB-ADCP velocity measurements were discussed in detail. In this chapter, we will discuss the methods used to calculate discharge from data collected using an ADCP. A basic knowledge of conventional river discharge-measurement techniques is necessary to understand how an ADCP measures discharge. Conventional ADCP discharge-measurement techniques are covered in Buchanan and Somers (1969).

Parts of an Acoustic Doppler Current Profiler Discharge Measurement

Just how is an ADCP used to measure discharge? The ADCP could be used as a conventional current meter. If an ADCP were mounted to a boat, the operator could position the boat at 30 or more stations (verticals) in the cross section. Velocities and depths could then be taken at each vertical, and the discharge calculated using the area/velocity method ($Q = AV$). Such a method would be only a slight improvement over the conventional boat-tagline discharge-measurement techniques.

The unique ability of the ADCP to continuously collect water-velocity profile data and ADCP-velocity (boat-velocity) data, relative to the bottom, lends itself to the use of a more sophisticated method of discharge-measurement integration. A velocity vector cross product at each depth bin in a vertical profile is calculated using ADCP-collected data. This cross product is first integrated over the water depth measured by the ADCP and then integrated, by time, over the width of the cross section. The following equations illustrate the integration method. The reader should try to envision them as descriptions of the discharge-measurement algorithm and mechanics.

Velocity Cross-Product Measurement Using an Acoustic Doppler Current Profiler

General Equation

The general equation (eq. 2.1) for determining river discharge through an arbitrary surface, s , is

$$Q_t = \int_s \bar{V}_f \cdot \bar{n} ds \quad (2.1)$$

where

Q_t = total river discharge, in cubic meters per second;

\bar{V}_f = mean water-velocity vector, in meters per second;

\bar{n} = a unit vector normal to ds at a general point; and

ds = differential area; in meters.

The General Equation, as Applied to Acoustic Doppler Current Profiler Moving-Boat Measurements

The above is just a form of the familiar equation $Q = AV$ integrated over a cross section. For moving-boat discharge applications, the area s is defined by the vertical surface beneath the path along which the vessel travels. The dot product of $\bar{V}_f \cdot \bar{n}$ will equal zero when the vessel is moving directly upstream or downstream, and will equal \bar{V}_f when the vessel is moving normal to \bar{V}_f ; both vectors are in the horizontal plane.

Because the ADCP provides vessel-velocity and water-velocity data in the vessel's coordinate system, it is convenient to recast equation 2.1 in the following form (eq. 2.2) (Christensen and Herrick, 1982):

$$Q_t = \iint_{00}^{T d} ((\bar{V}_f \times \bar{V}_b) \cdot \bar{k}) dz dt \quad (2.2)$$

where

T = total cross-section traverse time, in seconds;

d = total depth, in meters;

\bar{V}_b = mean vessel-velocity vector, in meters per second;

\bar{k} = a unit vector in the vertical direction;

dz = vertical differential depth, in meters; and

dt = differential time, in seconds.

The derivation of this equation by Christensen and Herrick (1982) is summarized in Simpson and Oltmann (1993). The equation originally was formulated by Kent Dienes (R.D. Instruments, Inc., oral commun., 1986).

The cross-product algorithm is well suited to ADCP discharge-measurement systems. Translated into nonmath terms, the above can be described as the cross product of the boat velocity and the water velocity first integrated over the cross-section depth and then integrated, by time, over the cross-section width (fig. 2.1).

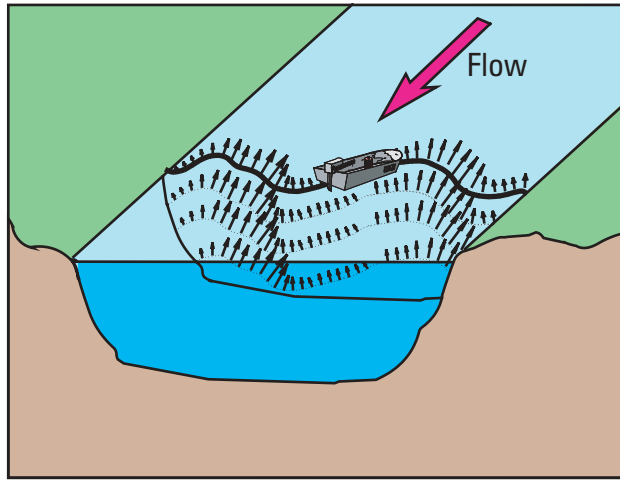

Figure 2.1. Cross-product vectors during a cross-section traverse.

The cross product part of equation 2.2, $(\bar{V}_f \times \bar{V}_b) \cdot \bar{k}$, can be converted to rectangular coordinates to facilitate plugging in boat- and vessel-velocity vectors (eq. 2.3).

$$(\bar{V}_f \times \bar{V}_b) \cdot \bar{k} = a_1 b_2 - a_2 b_1, \quad (2.3)$$

where

a_1 = cross component of the mean water-velocity vector, in meters per second;

a_2 = fore/aft component of the mean water-velocity vector, in meters per second;

b_1 = cross component of the mean vessel-velocity vector, in meters per second; and

b_2 = fore/aft component of the mean vessel-velocity vector, in meters per second.

This is simply called the velocity cross product, which can be represented as shown in equation 2.4:

$$f = a_1 b_2 - a_2 b_1, \quad (2.4)$$

where

f = the cross product of the water-velocity and boat-velocity vectors.

Properties of the Acoustic Doppler Current Profiler Measured Cross Product

Figure 2.2 shows the properties of the cross product. Note that the boat must be traversing a velocity field before the cross product becomes greater than

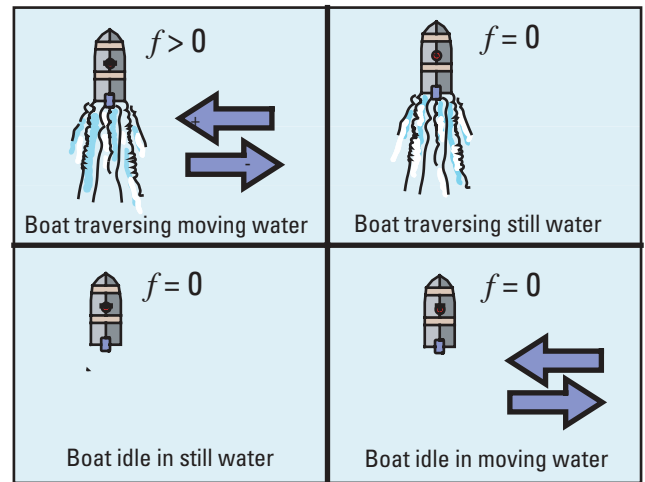

Figure 2.2. Properties of the water-velocity/boat-velocity cross product.

zero. In practice, several ADCP pings often are averaged to help reduce random error. This group of averaged water- and bottom-track velocity measurements is called an ensemble. The cross product is calculated from the averaged ensemble velocities and is expressed in units of square meters per second per second.

Integrating the Cross Product Over the Water Depth

When the cross product is integrated over depth, the resulting value is in cubic meters per second per second, and by substituting in the values for the beginning and ending times of each ensemble, a discharge value (cubic meters per second) is determined for each measured ensemble. The discharges for each ensemble then are summed to obtain total channel discharge (fig. 2.1). The mechanics of this operation require casting equation 2.2 into a form usable by the ADCP measurement software (eq. 2.5):

$$Q_m = \sum_{i=1}^{N_s} \left[\int_0^d f_z dz \right] t_i \quad (2.5)$$

where

Q_m = measured channel discharge (doesn't include the unmeasured near-shore discharge), in cubic meters per second;

N_s = number of measured discharge subsections;

i = index of a subsection;

d = depth of a subsection, in meters;

f_z = value of cross product at depth z ;

dz = integrated vertical depth of subsection i , in meters; and

t_i = elapsed traveltime between the ends of subsections i and $i - 1$, in seconds.

Estimating Cross Products in the Unmeasured Portions of the Profile

Problems arise when trying to implement the above summation for several reasons. To understand those reasons, the limitations of an ADCP water-velocity measurement are reexamined in the following sections.

Blanking Distance

Blanking distance was discussed in chapter 1, but is examined again here. Figure 2.3 is a modified version of figure 1.21 showing the unmeasured parts of a vertical-velocity profile. As discussed in chapter 1, the small ceramic element in the transducer is like a miniature gong. The large voltage spike of the transmit pulse bangs it like a hammer, and the vibrations, as well as the residual signal, must die off before the transducer can be used to receive incoming signals. This means that incoming signals are not used if they are received during a short period after the signal is transmitted. This time period is equivalent to a distance traveled by the signal known as the blanking distance. The blanking distance plus the transducer draft (depth of the transducer face below the water surface) compose a part of the near-surface profile that is not measured by the ADCP.

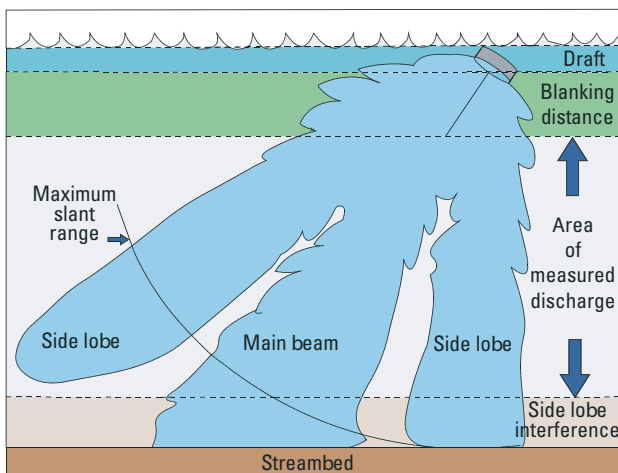

Figure 2.3. Acoustic Doppler current profiler-beam pattern showing side-lobe features.

Side-Lobe Interference

Most transducers emit unwanted (parasitic) side lobes of acoustic energy at 30–40° angles off the main beam. Figure 2.3 shows a slice of a typical transducer beam pattern. The side lobe probably is a single, hollow cone with its apex at the transducer (fig. 2.4). This is only the author’s mental image of the three-dimensional side-lobe structure, but the image probably is a simplistic view of the true pattern. This three-dimensional structure should be kept in mind when profiling close to obstacles. Most acoustic beams have parasitic side lobes (including external depth sounders that may be mounted on the vessel). As discussed in detail in chapter 1, up to 15 percent (depending on the beam angle) of the water column near the bottom cannot be measured because of interference from these side lobes.

The combination of the effects of transducer draft, blanking distance, and side-lobe interference yields a profile that is incomplete. To properly compute discharge for each subsection, the cross-product values near the water surface and near the bottom must be estimated.

As shown in figure 2.5, f values are not provided at or near the water surface and below a point equal to 85–94 percent of the total depth. The percent of unmeasured profile area depends on the beam angle. The unknown f values are labeled f_1 at the water surface and f_n at the channel bottom. The simplest method of estimating these f values would be to let f_1 at the surface equal f_2 and to let f_n at the bottom equal the last measured value (f_{n-1}) and approximate the

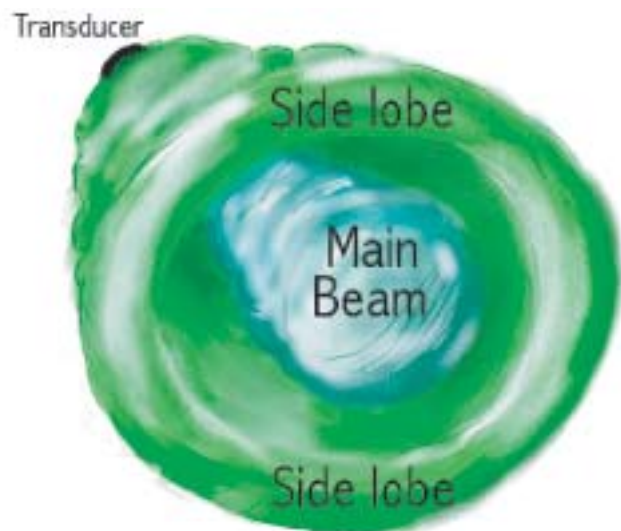

Figure 2.4. Hypothetical shape of a parasitic, side-lobe pattern.

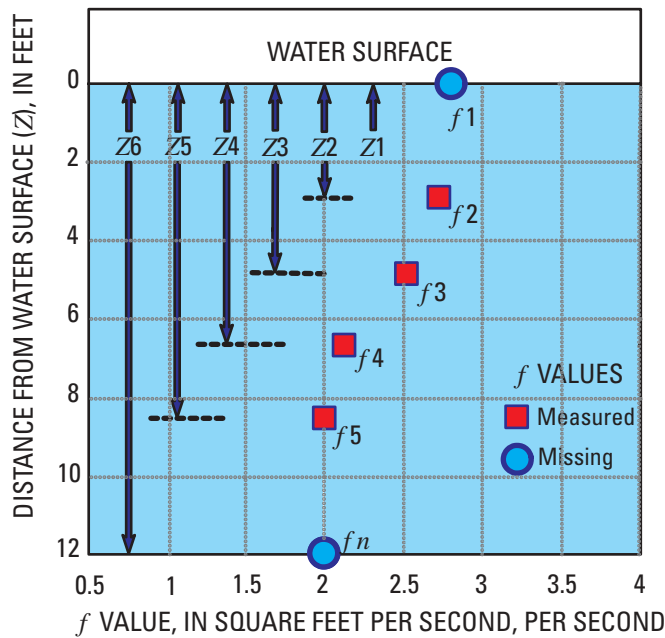

Figure 2.5. Example velocity profile showing measured and missing f values.

integral in equation 2.5 using a trapezoidal calculation (eq. 2.6):

$$g_i = \sum_{j=1}^{n-1} \left(\frac{f_j + f_{j+1}}{2} \right) (z_{j+1} - z_j), \quad (2.6)$$

where

- g_i = depth-weighted mean f value in measurement subsection i , in square meters per second per second;
- j = index of depths and respective f values;
- n = number of measured and estimated f values; and
- z_j = depth from water surface of respective measured and estimated f values.

Although equation 2.6 appears intimidating, it is nearly the same method as used on standard USGS discharge-measurement notes to sum discharge. In this case, however, it is used from surface to bottom rather than across the width of the river.

Evolution of the One-Sixth Power-Curve Estimation Technique

The above method might work, but, in most cases, water at the surface is moving faster than water deeper in the profile, and the water near the bottom of the profile slows to zero velocity as it nears the channel bed (assuming a stationary bed). There are exceptions

to this rule, especially in an estuary, but for general use, the top-most and bottom-most values in an ADCP-measured profile must be estimated to calculate an accurate ADCP discharge measurement.

The author attempted to calculate discharge using several different methods for profile estimation (Logarithmic and general power law), but found that because of “noisiness” of the ADCP-profile data, the resulting least-squares-derived estimates were unrealistic, especially near the upper part of the profile. A method using a one-sixth power law (Chen, 1989) eventually was chosen because of its robust noise rejection capability during most streamflow conditions. A full discussion of the one-sixth power law and its derivation can be found in Simpson and Oltmann (1993). The power law estimation scheme is an approximation only and emulates a Manning-like vertical distribution of horizontal water velocities. Different power coefficients can be used (one-half to one-tenth) to adjust the shape of the curve fit to emulate profiles measured in an estuarine environment or in areas that have bedforms that produce nonstandard hydrologic conditions and provide alternate estimation schemes under those circumstances. Figure 2.6 shows a one-sixth power curve drawn through the same set of f values that were illustrated in figure 2.5.

In cases where bidirectional flow exists (water is moving one direction at the surface and is moving the opposite direction near the channel bottom), the power-curve estimation scheme will not work. In these cases, the unmeasured areas must be estimated using other methods.

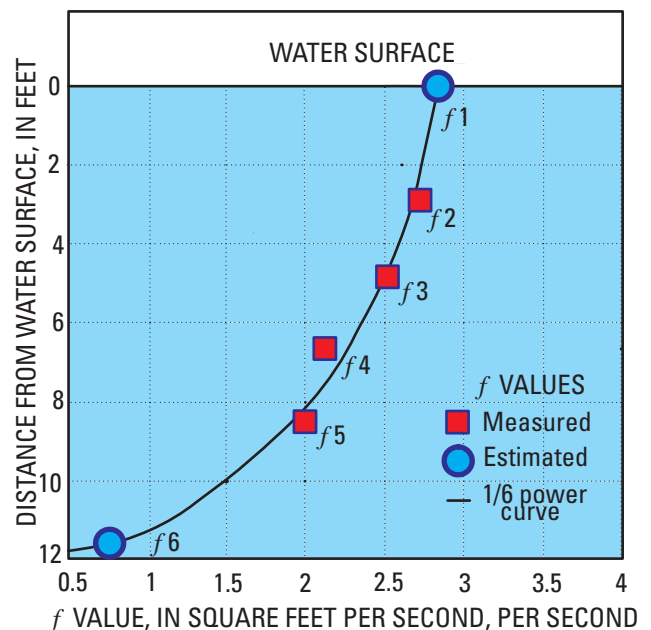

Figure 2.6. Example velocity profile of one-sixth power-curve fit and typical f values.

In most cases, points at the top and the bottom of the profile can be estimated using the one-sixth power-curve estimation scheme. The estimated points then are used with the actual measured points, to calculate a depth-weighted mean cross product for each ensemble. Discharge then can be calculated for each ensemble pair because the time between each ensemble is known.

Integration, By Time, Over the Width of the Cross Section

The summation in equation 2.5 is accomplished by equation 2.7

$$q_i = g_i t_i \quad (2.7)$$

where

q_i = midsection discharge between measurement subsection i and subsection $i-1$, in cubic meters per second;

g_i = depth-weighted mean f value in measurement subsection i , in square meters per second per second; and

t_i = vessel traveltime between measurement subsection i and $i-1$, in seconds.

Equation 2.5 is used to calculate the main channel discharge by summing all Q values (eq. 2.7) collected during the cross-section traverse. Unfortunately, before the total channel discharge can be calculated, two other areas need estimation schemes (fig. 2.7).

Estimating Discharge Near the Channel Banks

The power-curve fitting scheme estimates values in the areas at the top and bottom of the profile (blanking/draft distance and side-lobe interference

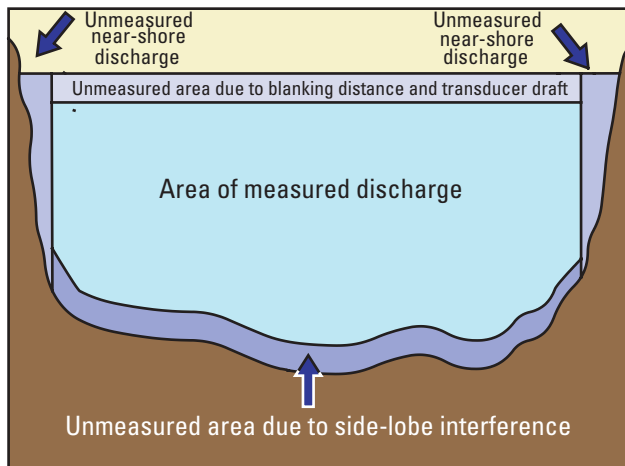

Figure 2.7. Unmeasured areas in a typical acoustic Doppler current profiler discharge-measurement cross section.

area), but, because of these and other ADCP depth limitations, shallow areas near the edges of the riverbank cannot be measured. The near-shore areas are estimated using a ratio interpolation method presented by Fulford and Sauer (1986), which can be used to estimate a velocity at an unmeasured location between the riverbank and the first or last measured velocity in a cross section. The equation for the estimate is equation 2.8

$$\frac{V_e}{\sqrt{d_e}} = \frac{V_m}{\sqrt{d_m}} \quad (2.8)$$

where

e = a location midway between the riverbank and first or last ADCP-measured subsection;

V_e = estimated mean velocity at location e , in meters per second;

V_m = measured mean velocity at the first or last ADCP-measured subsection, in meters per second;

d_e = depth at subsection e , in meters; and

d_m = depth at the first or last ADCP-measured subsection, in meters.

Fulford and Sauer (1986) defined d_m and V_m as depth and velocity at the center of the first or last measured subsection and not the near-shore edge of the subsection, as presented in equation 2.8. However, because the ADCP subsections purposely are kept very narrow at the start and finish of each measurement, the differences between the two applications are not significant (Simpson and Oltmann, 1993). Figure 2.8 illustrates the estimation method used for near-shore discharge. With this method, discharge can be estimated by assuming a triangular discharge area between subsection m and the riverbank, which reduces equation 2.6 to equation 2.9

$$V_e = 0.707 V_m \quad (2.9)$$

Remembering that $Q = AV$, discharge in the estimated area can be calculated by equation 2.10.

$$Q_e = \frac{0.707 V_m L d_m}{2} \quad (2.10)$$

where

Q_e = estimated edge discharge, in cubic meters per second; and

L = distance to the riverbank from the first or last ADCP-measured subsection, in meters.

The discharge-measurement software calculates depth (d_m) from the average of the depths measured on all four beams. The distance (L) to the riverbank from the first or last discharge measurement subsection is provided by the system operator using estimation

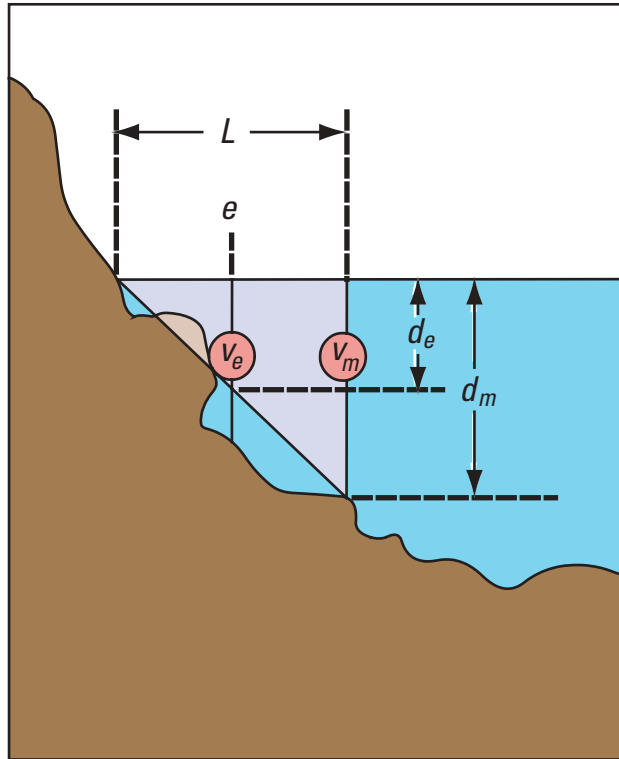

EXPLANATION

- v_e Estimated mean velocity at location e
- v_m Measured mean velocity at first or last ADCP-measured subsection
- d_e Depth at subsection e
- d_m Depth at first or last ADCP-measured subsection
- L Distance to the riverbank from the first or last ADCP-measured subsection
- e A location midway between the riverbank and first or last ADCP-measured subsection

Figure 2.8. Edge-value estimation scheme described by equations 2.8, 2.9, and 2.10. ADCP, acoustic Doppler current profiler.

techniques described in the chapter on discharge-measurement techniques.

The triangular ratio-interpolation method works well in parabolic-shaped natural channels, however, it does not work well in rectangular concrete channels or natural channels with nonstandard slopes near the banks. In these cases, a bank-slope coefficient can be used to properly depict the channel-bank geometry (see chapter 5.)

Determination of Total River Discharge—Putting it All Together

Using all the methods and equations described in this chapter, total river discharge (Q_t) can be calculated by equation 2.11

$$Q_t = Q_m + Q_{e_i} + Q_{e_r} \quad (2.11)$$

where

Q_m = total channel discharge [the sum of all q_i values collected during the discharge measurement traverse (eq. 2.7)], in cubic meters per second;

Q_{e_i} = near-shore discharge estimate on the left side of the channel, in cubic meters per second; and

Q_{e_r} = near-shore discharge estimate on the right side of the channel, in cubic meters per second.

Discharge-Measurement Software

Based on the above principles, the USGS, as well as the manufacturers of ADCPs, have written computer programs designed to collate ADCP data collected during a cross-section traverse and compute discharge in real time. Because of the difficulty in maintaining and updating such a program, the USGS has elected to use manufacturers' proprietary programs for this capability, provided the proper algorithms are used and quality assurance (QA) criteria are met. The current QA plan (Lipscomb, 1995) requires that the whole system (ADCP and discharge-measurement software) meet certain standards.

The USGS has an archetype computer program written in Pascal that can be used as a basis for a vendor-created software package. Because the archetype computer program has not been translated into machine code that will run on IBM personal computers and compatibles, most ADCP system operators utilize "Transect," a suite of proprietary software modules developed by RDI for use with their ADCPs. The

Transect software includes the estimation methods used by the USGS in the archetype program and has proven to be a useful, accurate discharge-measurement tool. Other manufacturers currently are developing similar software.

Summary

Unlike conventional discharge-measurement methods, acoustic Doppler current profiler (ADCP) discharge-measurement software does not calculate discharge directly from area and velocity data. The ADCP discharge-measurement software calculates a water/boat velocity vector cross product in each bin before integrating the cross products over the subsection depth. The resulting subsection discharges then are summed over the width of the cross section.

Discharge cannot be measured near the water surface because of the draft required by the transducer (depth below water surface) and transducer blanking

distance. Discharge cannot be measured near the channel bed primarily due to side-lobe interference. Cross products in these unmeasured portions of the channel cross-section usually are estimated using a one-sixth power-curve estimation scheme (unless the profile shape dictates other methods). Discharges in the unmeasured portions of the cross-section near the edges of the riverbank are estimated using a ratio-interpolation method.

The U.S. Geological Survey (USGS) has developed a discharge-measurement archetype program; however, most ADCP system operators are using a proprietary suite of software modules called “Transect” developed by R.D. Instruments, Inc., for use with their ADCPs. Transect includes the estimation methods used by USGS in the archetype program and has proven to be a usable, accurate discharge-measurement tool. Other manufacturers also are developing discharge-measurement software.

This page left blank intentionally.

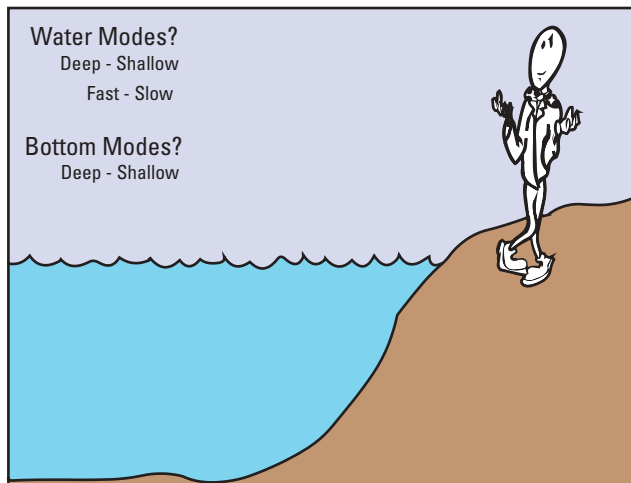

Figure 3.1. Choosing the proper measurement mode is difficult.

CHAPTER 3: R.D. INSTRUMENTS, INC., BROAD-BAND ACOUSTIC DOPPLER CURRENT PROFILER MEASUREMENT MODES

Measurement Modes—Why?

One of the most compelling features of ADCP systems is their versatility. Versatility comes with a cost, however, and the cost is added complexity. Most ADCPs have several water-measurement modes (fig. 3.1) and bottom-measurement modes. These modes are chosen based on environmental conditions (fast/slow or shallow/deep water and current shear). A simple matrix of mode choices for different measurement conditions would be desirable for this chapter, but, unfortunately, it's not that easy! Several environmental factors may play a part in the choice of measurement modes.

In an ADCP manufactured by RDI, these modes are set using direct commands placed in a configuration file (chap. 5). The BB-ADCP commands W (water mode) and B (bottom mode) can be set to different values depending upon the flow and bottom conditions expected at the discharge measurement site. Mistakes in setting these values may cause unrecoverable errors in the measurement of discharge. This chapter, therefore, is devoted to the explanation of the different operational modes available for ADCPs manufactured by RDI. It is quite likely that when this report is published, operational modes for ADCPs manufactured by RDI will be available that are not covered in this chapter. The manufacturer releases technical notes and bulletins when such changes are developed, which are available on the manufacturer's web site (www.rdinstruments.com).

Parameters that dictate the operation of water- and bottom-track measurement modes are set by direct commands sent to the profiler from the Transect configuration file (chap. 5). These direct commands take the form of W\$nnn, or B\$nnn, where W = water mode and B = bottom mode. The "\$" signifies the water- or bottom-mode parameter that receives the numeric value, nnn. These direct commands are discussed in detail in this chapter.

Water Modes

The water-measurement modes juggle different lag distances, pulse lengths, code element combinations, and adaptive schemes to measure water velocity under many hydrologic conditions. Some of these modes should be used with caution because errors can result if they are misapplied. Direct commands for these modes take the form of WMn, where n is 0, 1, 4, 5, 7, or 8, depending on the mode used.

Water Mode Zero (WM0)

Water mode zero (direct command WM0) is referred to as the "expert" mode because it allows the user to set virtually all aspects of the water-measurement ping structure. Water mode zero will not be addressed further in this report because it is almost never used under routine measurement conditions. When this mode is used, it is used in connection with instructions from the manufacturer and usually is used for special circumstances where other modes are inadequate.

Water Mode 1 (WM1)

Water mode 1 (direct command WM1) is called the "dynamic" mode. This is a general purpose mode that should be used (in preference to mode 4) for most routine measurement conditions—with one caveat; the ambiguity velocity must be set correctly for stream conditions. Operators can modify the ambiguity velocity (and, thereby, the lag spacing of the mode 1 ping structure) using the WV command. Proper adjustment of the WV value allows mode 1 to be used in shallow and deep water and in current shear where other modes fail. Ambiguities in the measurement of velocity are not automatically resolved in water mode and the maximum expected velocity of the boat (relative to the water) must be estimated before setting the WV command. If the value is set too low, an ambiguity error could be introduced into the velocity measurement (see chap. 1).

The default WV value (lag spacing) for mode 1 allows a high ambiguity velocity [480 centimeters per

second (cm/s), 16 ft/s]. The single-ping standard deviation of a velocity measurement using this default setting is about 19 cm/s (0.62 ft/s). This magnitude of uncertainty usually produces an unacceptable precision for the resulting discharge measurement, unless the measurement vessel is slowed to less than one-third of the speed of the absolute water velocity (water velocity relative to the Earth) during the cross-section traverse. Fortunately, the mode 1 default lag spacing can be changed by altering the WV command. Note: Most of the ambiguity-velocity directives expect radial (along-beam) ambiguity velocity, not horizontal ambiguity velocity. Radial ambiguity velocity can be determined using the following formula (eq. 3.1) if the desired horizontal ambiguity velocity is estimated

$$V_{radial} = 1.5(V_{horizontal})\sin\theta \quad (3.1)$$

where

V_{radial} = radial ambiguity velocity, in centimeters per second;

$V_{horizontal}$ = horizontal ambiguity velocity, in centimeters per second; and

θ = transducer beam angle, in degrees.

The horizontal ambiguity velocity can be estimated by adding the highest expected ADCP speed (relative to the water) and the highest expected absolute water velocity. This value is $V_{horizontal}$ and is plugged into equation 3.1 to arrive at a reasonable value for the WV command. It is multiplied by 1.5 in the equation for safety reasons. Usually, it is better to have a bit of extra noise (standard deviation of velocities) in the measurement than to inadvertently average in an ambiguity error. Table 3.1 shows the single-ping standard deviation for three different ambiguity-velocity values.

Mode 1 can be used in slightly more shallow water than mode 4 [1 m (3.3 ft)], but modes 5 or 8 are preferred for medium-to-slow velocities [below 10 cm/s (0.33 ft/s)] because of the increased resolution available with these modes. Mode 1 sometimes can be used in shallow water where modes 5 and 8 do not work because of high velocities and shear. Figure 3.2 shows the depth and velocity range windows wherein each mode is designed to function properly. Notice that mode 1 encompasses a much larger range of depths and velocities than do the other modes.

To increase the range of mode 1 in water depths near the edge of the ADCP measurement capability (depends on frequency), the operator can toggle the WB command from 0 to 1. According to the manufacturer, setting the WB command to 1 enables greater ADCP range by narrowing the received

Table 3.1. Mode 1 single-ping standard deviation using three different values for the WV command

[ADCP, acoustic Doppler current profiler; kHz, kilohertz; cm/s, centimeter per second; ft/s, foot per second]

ADCP frequency (kHz)	Ambiguity velocity (WV command)	Single-ping standard deviation
300	480 cm/s (15.78 ft/s)	19.35 cm/s (0.63 ft/s)
300	190 cm/s (6.23 ft/s)	14.07 cm/s (.46 ft/s)
300	60 cm/s (1.99 ft/s)	6.87 cm/s (.23 ft/s)
600	480 cm/s (15.78 ft/s)	19.35 cm/s (.63 ft/s)
600	190 cm/s (6.23 ft/s)	14.08 cm/s (.46 ft/s)
600	60 cm/s (1.99 ft/s)	6.87 cm/s (.23 ft/s)
1200	480 cm/s (15.78 ft/s)	19.37 cm/s (.64 ft/s)
1200	190 cm/s (6.23 ft/s)	14.08 cm/s (.46 ft/s)
1200	60 cm/s (1.99 ft/s)	6.87 cm/s (.23 ft/s)

Depth-range

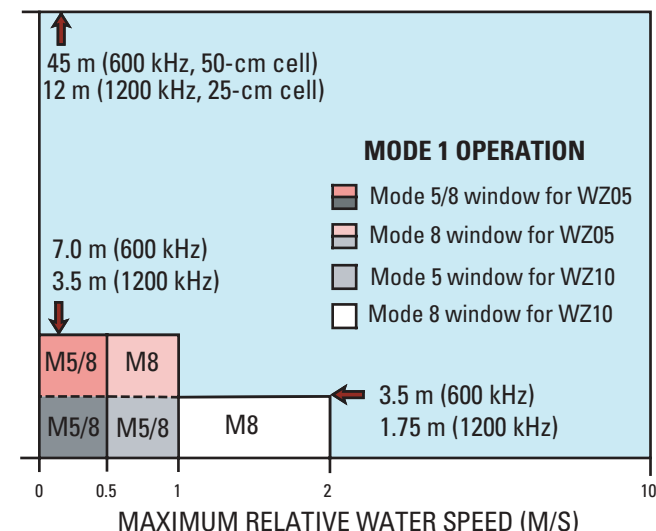

Figure 3.2. Depth/range/speed-operational “windows” for water modes 1, 5, and 8. m, meter; kHz, kilohertz; cm, centimeter; M/S, meter per second.

bandwidth (which improves the signal-to-noise ratio). Unfortunately this also increases the velocity measurement standard deviation by a factor of 2. See chapter 9 (table 9.1) for the maximum recommended ranges for ADCPs of different frequencies. The WB command only can be used for mode 1 operation. Setting WB to anything other than zero in other water modes will cause unpredictable results.

For routine discharge measurements in swift-flowing waters with depths greater than 2 m (6.5 ft), mode 1 is the mode of choice. The operator must set the WV command for the proper ambiguity velocity. Water

modes 2 and 3 are obsolete and are no longer used for riverine measurements.

Water Mode 4 (WM4)

Until recently, water mode 4 (default for the BB-ADCP) was used as the general production mode for water-discharge measurement. This mode is no longer recommended by RDI for discharge measurement because of hard-to-detect errors that can be introduced with automatic mode switching. Mode 4 uses a single set of pulses with a long lag that is dependent on depth cell length. The lag is either one-half the depth cell length or has a horizontal ambiguity velocity of 160 cm/s (5 ft/s), whichever is greater. The value of 160 cm/s (5 ft/s) is used for most depth cell sizes. Using the minimum depth cell size for a given operational frequency [25 centimeters (cm), 10 inches (in.)] for a 1,200-kHz BB-ADCP, for example, will decrease the lag, raise the ambiguity velocity slightly, and increase the measured water-velocity standard deviation. The ambiguity is resolved on this single set of pings by a proprietary signal-processing algorithm developed by the manufacturer (R.D. Instruments, Inc., 1996).

If necessary, mode 4 can be used in high- and low-velocity conditions. When depths become too shallow [2 meters (m) and below], or if the signal return is too weak, the ADCP will shift automatically to mode 1 operation. The operator is not notified when automatic mode switching occurs and it is recommended that an appropriate WV command be inserted into every configuration file that uses mode 4 operation. The WV command value can be estimated using equation 3.1 (see Water Mode 1 discussion).

Again, mode 4 is no longer recommended for discharge measurement use. It is only available on BB-ADCP systems and should be used only if directed by the manufacturer, or if mode 1 will not work.

Water Mode 5 (WM5)

Water mode 5 (“low and slow” mode) uses a true version of pulse-to-pulse coherent signal processing. The two transmitted pulses are completely independent of each other, but are synchronized in phase. To eliminate self noise in mode 5, the second pulse is not sent until the first pulse dies out. This procedure creates a long lag with low standard deviation of the measured water velocity.

Ambiguity Velocity Revisited

One problem with extra long lags is a low ambiguity velocity. Using the racetrack analogy from chapter 1, the first strobe flash (analogous to an

acoustic pulse) shows the car with the racing stripe leading the pack of racers (fig. 1.34a). The second strobe flash reveals that the pack of racers apparently has passed the racing-striped car and won the race (fig. 1.34b). Or does it? If the racing-striped car was actually moving three or four times faster than the other racers, it not only won the race but has almost “lapped” the rest of the racers. In this case, the racing-striped car has exceeded the velocity at which the timekeeper could determine its speed without ambiguity. In the case of mode 5 operation, this ambiguity velocity is relatively low [50 cm/s (1.7 ft/s) ADCP speed, relative to the water].

A long lag time increases the possibility of decorrelation between pulses. Using the above racetrack analogy, the photographer could overlay the negative of the first strobe flash on the negative of the second strobe flash and then rotate the negatives until the “pack” of cars are aligned. When the pack of cars are aligned, the checkered flag on the first negative will be a certain distance from the checkered flag on the second negative. By using this distance and the time between strobes, the speed of the pack of cars can be computed. This method of speed computation works unless the time between strobes becomes so long that the cars in the pack change position, lanes, or speeds. If this happens, the cars will not “match up” when the negatives are rotated. The two negatives are then said to be uncorrelated. This effect can occur using mode 5 if there is shear and turbulence in the water column.

Because of the above two effects, mode 5 is not usable in water with substantial velocity, shear, or turbulence. However, in slow-moving water with little current shear, mode 5 can be used to obtain highly precise discharge measurements. Because of the high precision of mode 5, smaller bin lengths can be used, which enables mode 5 to be used in shallow water. Direct command changes must be made for mode 5 operation. The WZ command sets the starting length of the mode 5 and mode 8 lags and it is recommended that a command of WZ05 be used as a starting point for mode 5 and mode 8 operation. Table 3.2 describes water mode 5 performance for the specified setup.

Water Mode 7 (WM7)

Water mode 7 (extended range mode) is used to obtain water profiling at ranges 10–15 percent greater than profiling ranges available in other modes. Mode 7 converts the BB-ADCP system to a system similar to a narrow-band ADCP, thereby increasing the signal-to-noise ratio and range. This mode is practical only for 75-, 150-, and 300-kHz BB-ADCPs and is intended for open-ocean use where extended depth range is needed. Mode 7 water-velocity measurements have

Table 3.2. Setup and performance values for water mode 5 operation (WZ05)

[kHz, kilohertz; cm, centimeter; cm/s, centimeter per second; m, meter; ft/s, foot per second; ft, foot. WF, WS, keyboard commands]

Acoustic Doppler current profiler operating frequency (kHz)	Blanking distance WF, (cm)	Depth cell size, WS (cm)	Single-ping standard deviation (cm/s) (ft/s)	Range to first depth cell (m) (ft)	Minimum profiling range (m) (ft)	Maximum profiling range (m) (ft)
600	25 (WF25)	10 (WS10)	0.5 cm/s (0.16 ft/s)	0.35 m (1.15 ft)	0.9 m (2.95 ft)	7.0 m (23.0 ft)
600	25 (WF25)	25 (WS25)	.3 cm/s (.010 ft/s)	.50 m (1.64 ft)	1.6 m (5.25 ft)	7.0 m (23.0 ft)
600	25 (WF25)	50 (WS50)	.2 cm/s (.007 ft/s)	.75 m (2.46 ft)	2.2 m (7.18 ft)	7.0 m (23.0 ft)
1200	25 (WF25)	5 (WS05)	.6 cm/s (.020 ft/s)	.30 m (.98 ft)	.8 m (2.63 ft)	3.5 m (11.5 ft)
1200	25 (WF25)	10 (WS10)	.4 cm/s (.013 ft/s)	.35 m (1.15 ft)	.9 m (2.95 ft)	3.5 m (11.5 ft)
1200	25 (WF25)	25 (WS25)	.3 cm/s (.010 ft/s)	.50 m (1.64 ft)	1.6 m (5.25 ft)	3.5 m (11.5 ft)

approximately 2.5 times the standard deviation of velocities measured with a mode 4 ping using the same depth cell size.

Water Mode 8 (WM8)

Water mode 8 is for shallow water and will sometimes work in conditions where mode 5 will not. This mode uses a pulse-to-pulse coherent configuration much like mode 5 to calculate velocity, but employs sophisticated signal processing techniques to reduce lag times. A mode 8 ping has a single-ping standard deviation 10 times greater than a mode 5 ping of the same bin size, but can be used in shallow water in much the same manner as mode 5. Setups for mode 8 are the same as the setups for mode 5. Table 3.3 gives the conservative values provided by the manufacturer for mode 8 performance (R.D. Instruments, Inc., 1995). Under certain circumstances, the operator may see up to a 30 percent improvement over the maximum depth range and maximum velocities listed in table 3.3; however, it is best not to expect optimum performance under field conditions.

Range/Speed “Windows” for Water Modes 1, 5, and 8

Figure 3.2 shows a graphic rendition of the depth-range/speed operational “windows” for water modes 1, 5, and 8. Notice that mode 1 is, by far, the most robust operational mode, with the largest operational range of depth and relative water speed. For slow velocities with shallow depths, mode 5 is the mode-of-choice, especially with 600-kHz ADCPs.

Mode 8 sometimes will work in shallow water where relative water velocities are too high for mode 5 operation. The higher standard deviation of the mode 8 measurements usually requires some data averaging, or a slow cross-section traverse (at speeds below that of the water speed, relative to the Earth).

Bottom-Track Modes

Bottom-track modes are implemented independently of the water-velocity measurement modes and sometimes are set differently. There are two bottom-track modes currently used by the BB-ADCP: modes 4 and 5. Bottom-track modes 1–3 are obsolete. Other bottom-track modes may be available by the time this report is published.

Bottom tracking is done by proprietary firmware schemes built into the ADCP by the manufacturer; however, all such schemes must rely on the assumption that the bottom reflection obeys basic laws of physics. These principles of bottom tracking should be known by the ADCP operator to properly evaluate bottom tracking under variable field conditions.

The Bottom Reflection

When an acoustic signal strikes the river bottom, the reflected signal normally is much stronger (by orders of magnitude) than the reflected signal from scatterers in the water mass. It is no surprise, therefore, that the standard deviation of the bottom-track velocity measurement is about 10 times less than the water-mass

Table 3.3. Setup and performance values for water mode 8 operation (WZ05)

[kHz, kilohertz; cm, centimeter; cm/s, centimeter per second; m, meter; ft/s, foot per second; ft, foot. WF, WS, keyboard commands]

Frequency (kHz)	Blanking distance WF (cm)	Depth cell size, WS (cm)	Single-ping standard deviation (cm/s) (ft/s)	Range to first depth cell (m) (ft)	Minimum profiling range (m) (ft)	Maximum profiling range (m) (ft)
600	25 (WF25)	10 (WS10)	8.2 cm/s (.27 ft/s)	0.35 m (1.15 ft)	0.6 m (1.97 ft)	7.0 m (23.0 ft)
600	25 (WF25)	25 (WS25)	5.2 cm/s (.17 ft/s)	.50 m (1.64 ft)	.9 m (2.95 ft)	7.0 m (23.0 ft)
600	25 (WF25)	50 (WS50)	3.7 cm/s (.12 ft/s)	.75 m (2.46 ft)	1.4 m (4.59 ft)	7.0 m (23.0 ft)
1200	25 (WF25)	5 (WS05)	11.0 cm/s (.36 ft/s)	.30 m (.98 ft)	.5 m (1.64 ft)	3.5 m (11.5 ft)
1200	25 (WF25)	10 (WS10)	7.8 cm/s (.26 ft/s)	.35 m (1.15 ft)	.6 m (1.97 ft)	3.5 m (11.5 ft)
1200	25 (WF25)	25 (WS25)	5.0 cm/s (.164 ft/s)	.50 m (1.64 ft)	.9 m (2.95 ft)	3.5 m (11.5 ft)

velocity measurement. Figure 3.3 shows a 1,200-kHz ADCP backscattered intensity (measured in counts) that decreases with depth until the acoustic beam strikes the river bottom at a depth of approximately 7 m (23 ft). Data averaged from a series of water-track pulses were used to construct figure 3.3, but a single bottom-track pulse backscattered-intensity plot would look much the same.

Modern bottom-track schemes are self adaptive to stream conditions and use factors such as correlation magnitude, correlation side peak location, and (or) spectral width to determine the presence of the bottom echo. Still, bottom-track failures can occur when one or more of the parameter identification criteria are not met by the output signal or, for some reason, are met at the wrong time.

In the case of heavy sediment load, which causes high absorption and scattering of the acoustic signal, the weakened bottom reflection (from deep water) cannot activate a detection threshold. In some cases, when this happens, the ADCP firmware is programmed to try other (more robust) bottom-tracking modes before flagging the data as “bad.”

Another problem occurs during periods of high flow when heavy sediment loads are moving on or near the channel bed; the bottom-track velocities become biased. The physical process that causes this phenomenon is theorized only at this time. Attempts have been made to overcome this bias problem by using lower frequency systems and special bottom-track schemes. A separate method of measuring vessel velocity that eliminates the need for bottom tracking

can be used; the input from a differential global positioning systems (GPS) receiver and depth sounder is used to replace the data from the ADCP bottom-track pulse. Because this method requires that the operator have an indepth understanding of GPS systems, as well

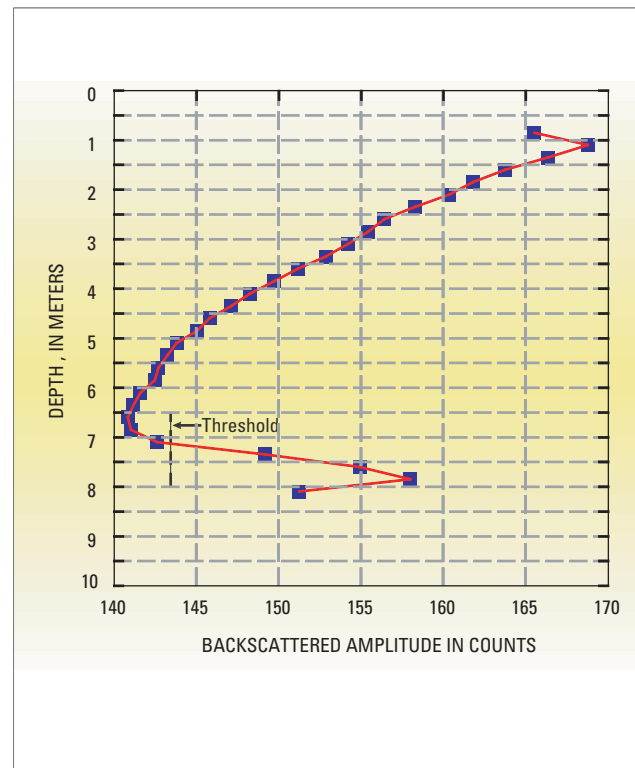

Figure 3.3. Acoustic Doppler current profiler-backscattered intensity with depth showing the bottom reflection.

as significant investment in additional GPS and depth sounding equipment, it will not be discussed in this report. For more information on using this method for discharge measurements during conditions of bottom-sediment movement, contact the ADCP manufacturer.

Bottom-Track Mode 4 (BM4)

Bottom-track mode 4 is a general-purpose bottom-track mode. This mode can unambiguously determine the speed of the ADCP, relative to the channel bottom, under most conditions. The detailed detection scheme used is proprietary and copyrighted by RDI, but mode 4 uses the correlation side-peak position to resolve velocity ambiguities and it lengthens the lag at predetermined depths to improve variance. Bottom-track mode 4 can be used with water-track modes 1, 4, 5, 7, and 8; however, because of processing limitations, the standard deviation of bottom-track velocity data (using mode 4) increases as depth decreases.

Bottom-Track Mode 5 (BM5)

Bottom-track mode 5 is the default mode for most discharge-measurement and velocity-profiling use. This mode uses a pulse-to-pulse coherent technique that has a lower variance in shallow water than bottom-track mode 4 by a factor of up to four. In very shallow water at slow speeds, mode 5 variance is lower than mode 4 by a factor of 100. Although mode 5 has a very precise measurement capability, it has a slightly slower ping rate than mode 4. Bottom-track mode 5 will automatically switch to bottom-track mode 4 when water is too deep (or too fast) for mode 5 operation. Because of this adaptive capability, mode 5 is the mode of choice for small rivers and estuaries (table 3.4). Table 3.4 lists the minimum bottom-tracking depths for bottom-track modes 4 and 5.

Table 3.4. Minimum depth ranges for bottom-track modes 4 and 5

[kHz, kilohertz; m, meter; ft, foot]

Frequency (kHz)	Depth (m) (ft)
1200	0.8 m (2.6 ft)
600	.8 m (2.6 ft)
300	1.5 m (5 ft)

At least one other ADCP manufacturer has developed the software and system firmware (bottom-tracking algorithms) for the measurement of river discharge; however, at the time this report was written, no detailed information was available for analysis and publication.

Summary

Water-track modes and bottom-track modes are independent of each other and must be carefully chosen, depending upon the stream conditions. In general, a good starting point for measurements at an unfamiliar site is water mode 1 (WM1) and bottom-track mode 5 (BM5). In cases of slow-moving, shallow flow, water mode 5 should be tried first, followed by water mode 8, followed by modified versions of mode 1 (use bottom-track mode 5 in all cases). In cases of high velocities, high shear, abrupt boat movements, or dynamic depth conditions, default and modified versions of mode 1 can be tried with a slow cross-section traverse to reduce random error. In such cases, bottom-track mode 4 probably should be used.

The theory of ADCP discharge measurement has been discussed in chapters 1–3. Chapters 4–9 introduce “practical” techniques and equipment.

CHAPTER 4: ACOUSTIC DOPPLER CURRENT PROFILER HARDWARE AND ANCILLARY EQUIPMENT

In this chapter we discuss the equipment needed to measure river discharge with an ADCP (fig. 4.1). Although a generic discussion of ADCPs is provided in this report, the following three sections cover the ADCP manufactured by RDI. The reason for this is twofold:

- Until recently, RDI was the only manufacturer of ADCP systems that could be utilized for discharge measurements (bottom-track algorithms). Another vendor (Sontek) has developed a bottom-tracking ADCP that can be used for discharge measurements, but the system is not yet widely used by the USGS
- As discussed in chapter 2, RDI has written discharge-measurement software that is integrated with the ADCP to calculate discharge and to store data (Transect software). Knowledge of the details of this software is required for the collection of accurate discharge measurements.

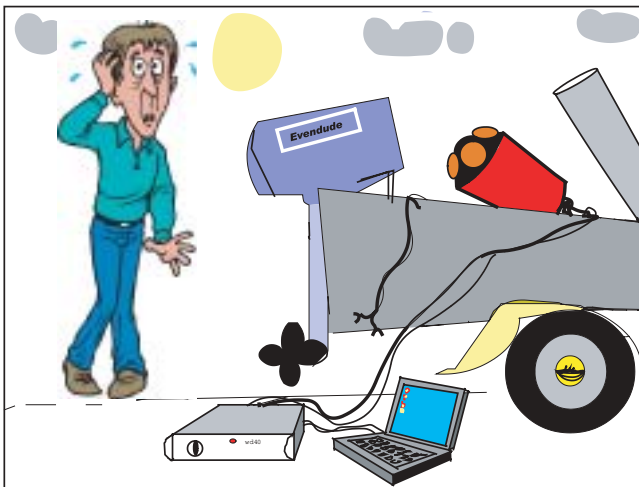

Figure 4.1. “Which equipment do we need?”

When another ADCP manufacturer produces a capable system that is used by a significant number of USGS offices, a description of that system (and its associated software) will be included in a follow up to this report.

Where Do We Start?

The following equipment is needed to measure river discharge with an ADCP:

ADCP system

- Pressure case and transducer assembly
- Power supply and communications interface
- Discharge-measurement software
- Manufacturer’s documentation

Ancillary equipment

- Measurement platform or vessel
- ADCP mounting assembly
- Laptop computer
- Range finder or method for estimating distance to shore

Of course, the measurement equipment is worthless unless used by a competent, well-trained ADCP operator. If a boat is used, the skipper must be experienced in boat-maneuvering techniques required for ADCP discharge measurement and must have attended a U.S. Department of Interior (DOI) boat safety course.

Acoustic Doppler Current Profiler Equipment

Acoustic Doppler Current Profiler Pressure Case and Transducer Assembly

The direct-reading BB-ADCP is configured much like the narrow-band ADCP (Simpson and Oltmann, 1993); however, the transducer and electronics are contained in the same cylindrical enclosure (pressure case). The diameter of the enclosure is approximately 150–220 millimeters (mm), depending on the configuration. A convex or concave transducer assembly on one end of the cylindrical canister employs an orthogonal (Janus) beam aiming

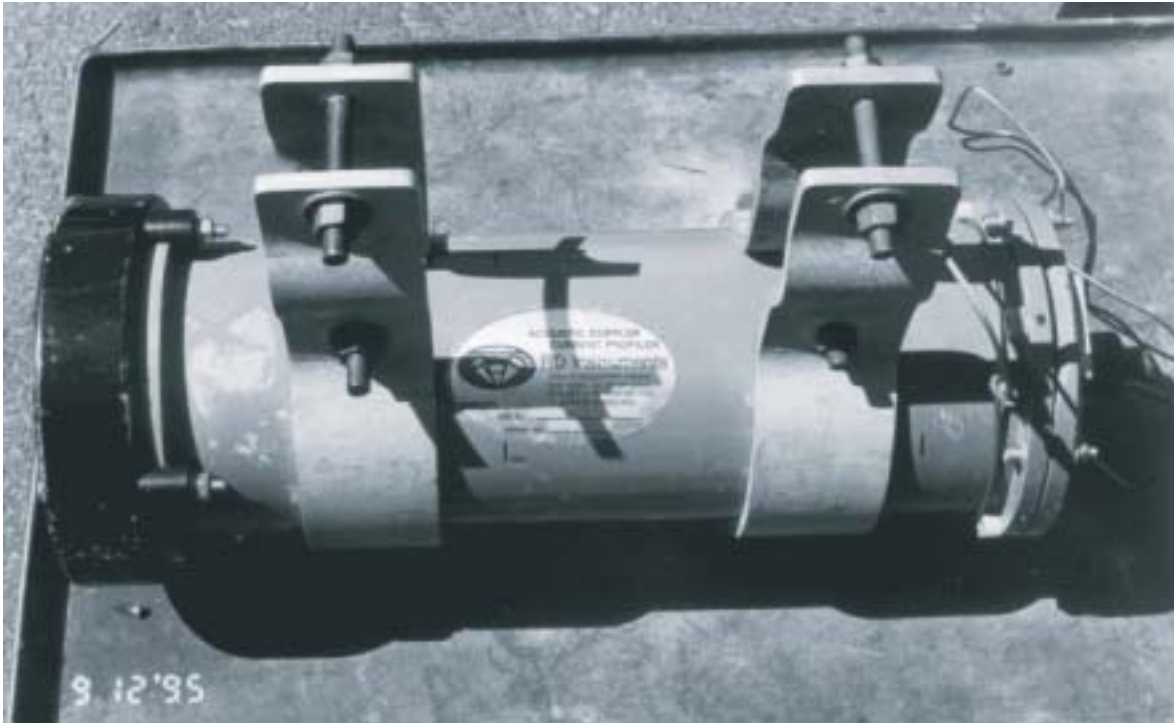

Figure 4.2. A 1,200-kilohertz broad-band acoustic Doppler current profiler with attached pipe brackets.

pattern with the three or four transducer beams angled 20° (or optionally 30°) outward from the center axis of the assembly. The transducer assembly diameter depends on the frequency of operation and configuration. For most work, the concave transducer head has proven to be more durable because it is protected somewhat from floating debris and direct contact with the river bottom. Figure 4.2 shows a BB-ADCP with a 1,200-kHz concave transducer assembly with pipe brackets attached.

RDI has introduced another version of the BB-ADCP into its product line called the “Workhorse.”

The Workhorse line of ADCPs can be purchased with or without bottom-tracking capability. A river version of the Workhorse (the Rio Grande, fig. 4.3) is available with bottom-tracking and operational modes suited to river-discharge measurements.

Power Supply and Communications Interface

For BB-ADCP direct-reading units, the manufacturer supplies a deck unit with the BB-ADCP that can convert several power sources to voltages required by the BB-ADCP. The deck unit can accept 120-volt (V) alternating current (AC), 20- to 60-volt



Figure 4.3. An R.D. Instruments, Inc., 600-kilohertz Workhorse “Rio Grande” acoustic Doppler current profiler.

direct current (DC), or 12-volt DC (fig. 4.4). The deck unit has a power switch on the front panel as well as two luminescent electronic display (LED) indicators. One LED indicator lights up when power is applied to the deck unit, and the other LED indicator lights up when

data are being transmitted to and from the ADCP. A 13-mm (0.5-inch) diameter cable connects the BB-ADCP to the deck unit assembly. At the ADCP end, the cable is potted to an underwater connector (fig. 4.5). The shell connector at the deck unit end of the cable has

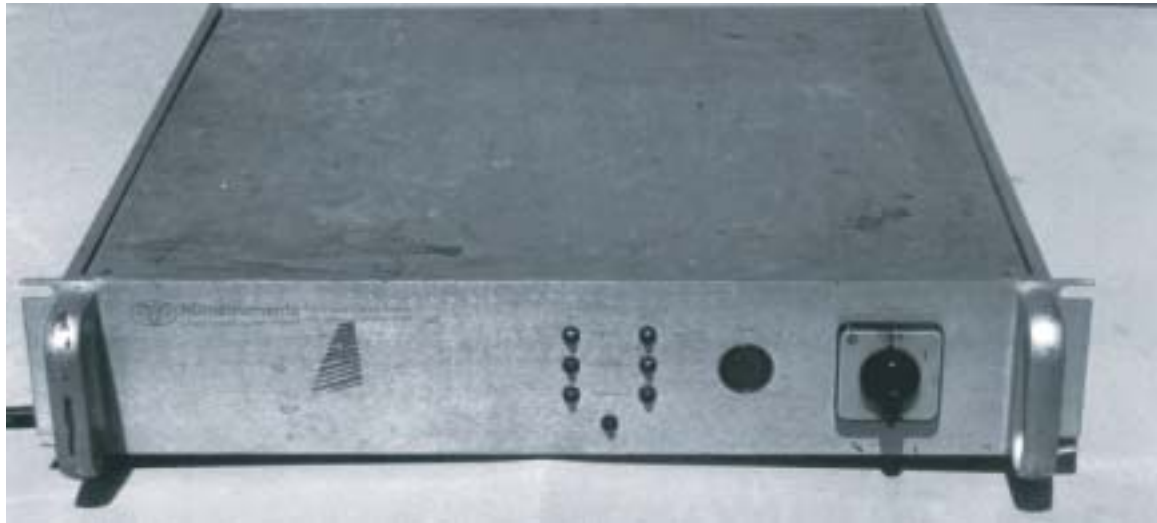

Figure 4.4. Front and rear view of an R.D. Instruments, Inc., acoustic Doppler current profiler deck unit.

24 pins and uses a bayonet-style connector. The overhang on the back of the deck unit can hinder the ability to easily disengage this connector and many users do not fully engage the bayonet mechanism. Connectors for RS-232 serial communications, power connections, and fuse holders also are on the back panel of the deck unit. The fuses protect the ADCP and deck unit in the event of short circuits and incorrect (reverse) battery polarity.

The manufacturer also markets an ADCP product known as the “Workhorse Rio Grande” (fig. 4.3) that does not require a separate deck unit. The Workhorse is powered directly from a DC source, or optionally from a 120-volt AC to a 12-volt DC converter. The Workhorse communications cable and the power supply cable are attached to the pressure case by way of a submersible connector.



Figure 4.5. Connector cable for attachment of R.D. Instruments, Inc., broad-band acoustic Doppler current profiler to accompanying deck unit.

Acoustic Doppler Current Profiler Discharge-Measurement Software

To measure river discharge, the ADCP system is controlled by discharge-measurement software (chaps. 2, 3). The configuration of this software is discussed in detail in chapter 5.

Documentation

The manufacturer provides several pieces of documentation that are essential for the proper operation and setup of the BB-ADCP including “The Direct Reading and Self-Contained BB-ADCP Technical Manual” (R.D. Instruments, Inc., 1995). For those using the Workhorse Rio Grande, RDI provides “Workhorse Rio Grande Technical Manual P/N 957-6101-00,” November 1999. Also needed is the Transect Program users manual for the broad-band acoustic Doppler current profilers (R.D. Instruments, Inc.,

1994). The technical manual is shipped with each ADCP; however, the Transect computer software and manual must be purchased separately. The Transect software and users manual are shipped as computer diskettes. Both manuals are updated periodically and hard copies of these updates can be obtained from the manufacturer for a fee. The manufacturer also maintains an internet web site that provides downloadable copies of the latest ADCP documentation updates, technical bulletins, and complete manuals (www.rdinstruments.com). The operator also should become familiar with the “Quality assurance plan for discharge measurements using broad-band acoustic Doppler current profilers” (Lipscomb, 1995).

Ancillary Equipment

Measurement Platform or Vessel Requirements

Discharge measurement platform or vessel requirements will vary, depending on the size and flow rates of the rivers and streams. For example, if measurements are in large rivers or estuaries, the BB-ADCP may be mounted on a 9- to 15-m (30- to 50-foot) vessel with an enclosed cabin. If, on the other hand, discharge measurements are on small, slow-moving rivers, the vessel of choice may be a 5- to 6-m (16- to 20-foot) skiff. For very small streams or rivers with minimal wave action, the BB-ADCP may be mounted on an inflatable boat, such as a Zodiac.

For improved safety while taking measurements that would be hazardous using manned platforms or to avoid traffic hazards, the USGS Indiana District has developed a tethered platform (fig. 4.6). For flood work and bridge scour measurements, the USGS Office of Surface Water has developed a prototype radio-controlled platform (fig. 4.7).



Figure 4.6. Tethered acoustic Doppler current profiler discharge measurement platform.



Figure 4.7. Radio-controlled, 12-foot, broad-band acoustic Doppler current profiler platform.

The proper boat choice will depend on the topography and hydrology of the area of interest; however, it is best to have several alternative vessels for discharge measurement use. In the USGS California District, three boats are used for ADCP discharge measurements. Figure 4.8 shows a 30-m (95-foot) vessel with a side-swing mount. Using this configuration, measurements in the estuary can be obtained under all but the worst of conditions.

Figure 4.9 shows a similar mount on a 6-m (20-foot) Boston Whaler. This vessel can be used in estuaries, rivers, and in river tributaries. A large 150-horsepower (hp) engine is used to get from place to place quickly when making discharge measurements in an estuary or river delta. A smaller engine is used when making discharge measurements in small rivers and



Figure 4.8. Two views of an acoustic Doppler current profiler side-swing mount on a 30-meter (95-foot) vessel.

slow-moving water. This vessel can be rigged with canvas for inclement weather.

Figure 4.10 shows a side-swing mount on a 4.5-m (15-foot) Boston whaler. This vessel is easily trailerable and is used when measuring small rivers. The main engine has a four-cycle, 45-horsepower engine that can be idled at low speeds for discharge measurement. This configuration is used mainly in fair weather; however, canvass also can be rigged to make the vessel usable in inclement weather.

When making discharge measurements in narrow rivers, a trolling plate can be used on the main

engine or an electric trolling motor can be used to slow the vessel. For accurate measurements in very slow-velocity water, this vessel can be pulled on a tagline.

In Sweden, BB-ADCP operators have used a small, inflatable dinghy when making discharge measurements (fig. 4.11). The advantage of this type of vessel is that launch ramps are not needed. The dinghy can be inflated on the riverbank and the equipment set up for use in less than 30 minutes.

It is imperative that not only the correct boat be used for any given set of river and weather conditions, but also that boat operators be properly trained. Correct



Figure 4.9. Side-swing mount on a 6-meter (20-foot) Boston Whaler for an acoustic Doppler current profiler.

operation of the boat is vital to obtaining high-quality discharge and velocity measurements. The DOI requires that boat operators attend a DOI motor boat operators training course before operating a USGS boat or vessel. All passengers on USGS vessels should wear life jackets (type V or better) and observe all U.S. Coast Guard and USGS water safety regulations.

Laptop Computer

The computer selection for running the BB-ADCP software is very important. Because of

the amount of data processing required, the computer must have an i286 central processing unit (CPU) or equivalent (an i386, i486, or Pentium CPU is desirable), and also must be IBM compatible. The computer at least must be capable of displaying extended graphics array (EGA) compatible graphics. Because of the amount of data storage required, a hard drive (nonvolatile ram drive) should be used with at least 20 megabytes (Mb) of available storage space.

The computer screen display should be visible in direct and diffuse sunlight (fig. 4.12). Those computers that do not rely on backlighting for display illumination



Figure 4.10. Side-swing mount on a 4.5-meter (15-foot) Boston Whaler for an acoustic Doppler current profiler.

seem to have the most visible display in direct sunlight. Standard monochrome liquid crystal display (LCD) and LEDs have the best visibility. Active matrix color displays have fair-to-poor visibility, and dual scan color LCD displays have poor-to-no visibility in direct sunlight. The computer purchase should be based on the computer's ability to run the Transect software and on the visibility of the screen display in direct sunlight.

For routine collection of streamflow data, a rugged laptop computer is desirable. Several manufacturers now produce laptops with antiglare

screen coatings, shock-mounted hard drives, and water-resistant keyboards and access panels. Standard laptops have minimal protection from the elements; rain and dust protection are not provided and many have flimsy plastic doors covering the port connections. These plastic doors fall off or are easily broken (fig. 4.13).

Do not rely on the internal laptop battery to provide power for an all-day measurement session because most laptop batteries will not last beyond about 3 hours and many will not last 1 hour before requiring recharge. Most of these rechargeable batteries tend to



Figure 4.11. Acoustic Doppler current profiler mount for an inflatable dinghy.

gradually lose capacity with age. The measurement system operator should attempt to power the computer from an external battery with a large capacity, such as an external 12-volt automobile or deep-cycle marine battery. Many of the newer laptops do not directly accept 12-volt power and require special adapters for power conversion. These adapters should be purchased with the computer, if possible, because they may be unavailable with ensuing computer model changes. Most adapters have a cigarette lighter plug at the 12-volt end of the adaptor. The cigarette lighter plug can be replaced with two alligator clips that can be attached directly to battery terminals. Another alternative for laptop power is to purchase a 200-watt (W) inverter. There are several small efficient inverters on the market today that do not draw excessive power under idle conditions. The inverter is connected to the 12-volt batteries and the computer AC adaptor is plugged into the inverter.



Figure 4.12. Laptop computer screen in diffuse sunlight.

The data-processing computer is connected to the BB-ADCP through a serial connection on the back of the deck unit. Normally, this serial connection is RS-232c; however, for long cables (longer than 200 ft), RS-422 protocol should be used. RS-422 protocol requires the use of a separate converter box as well as changes in the internal BB-ADCP switch settings (R.D. Instruments, Inc., 1995). The RS-232c serial connection is provided by way of a standard IBM personal computer (PC) 9-pin female to 25-pin male adaptor cable, which is available in most computer shops. A null-modem adaptor is not needed.

The computer must be protected from direct sunlight and heat during data collection. The LCD screen turns dark and unusable if it remains in direct sunlight too long. The computer also can be damaged by the heat of direct exposure to the sun. One solution is to place the computer inside an empty cooler that is turned on its side. The cooler shades the computer and



Figure 4.13. Laptop computer with missing plastic doors and port covers.

LCD from direct sunlight and also protects the computer from splashing water.

Acoustic Doppler Current Profiler Mounts

For discharge measurement or profiling, the BB-ADCP is positioned with the transducer assembly facing downward into the water column with beam three oriented forward. The BB-ADCP can be mounted in many different ways, but two methods have been used for most deployments; the side-swing mount and the “sea chest” mount.

Figures 4.14 and 4.15 show two types of side-swing mounts that have been used successfully. An inexpensive mount made from 51-mm (2-inch) aluminum pipe and 51-mm by 305-mm (2-inch by 12-inch) lumber is shown in fig. 4.14, and a more expensive mount fabricated from 6061-T aluminum is shown in fig. 4.15. These types of mounts have been used on boats that range in length from 4–30 m



Figure 4.14. Inexpensive acoustic Doppler current profiler mount.

(14–95 ft) and on streams 3.5 m (10 ft) wide and on rivers as wide as 1.6 km (1 mi). These mounts have the disadvantage of being far from the boat keel and, therefore, are subject to altitude changes caused by pitch and roll. However, for most applications, these mounts produce acceptable results.

Figure 4.16 shows a “sea-chest” mount that has been used successfully for narrow-band ADCPs and can be modified for use with BB-ADCPs. The “sea-chest” mount has the advantage of being close to the

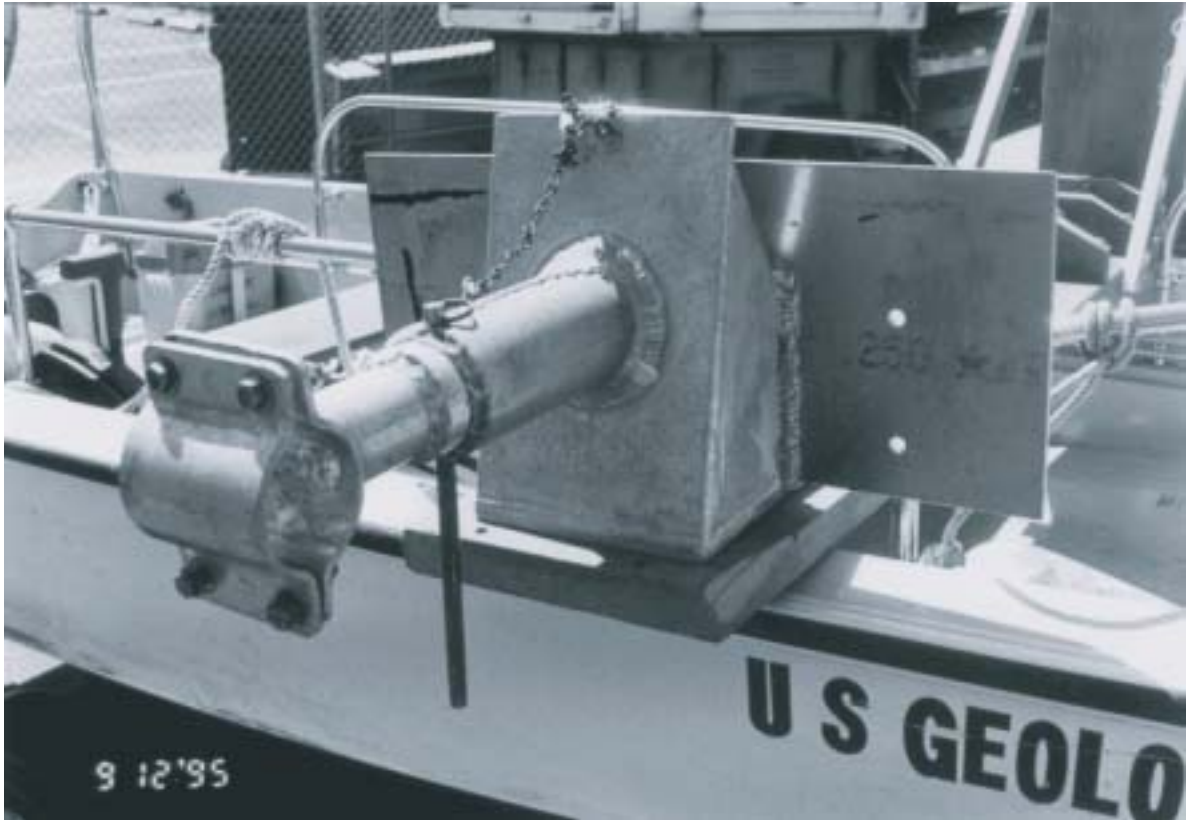

Figure 4.15. Aluminum acoustic Doppler current profiler mount.

boat keel and, therefore, less subject to altitude changes due to pitch and roll. The position also places the BB-ADCP away from edges of the boat wake where entrained air is present. Entrained air can cause loss of bottom track.

ADCP operators at Tampa, Florida, have developed a variant of the swing mount (fig. 4.17) that allows the BB-ADCP to be easily swung aboard the measurement vessel. A hydraulic mount was designed and installed on a “john boat” in the USGS Indiana District (fig. 4.18). A unique variant of the transom mount was designed by Harry Hitchcock of the USGS Kentucky District (fig. 4.19). An inboard variation on

the transom swing mount is being used by the USGS Illinois District (fig. 4.20). An easily detachable swing mount was designed and used by the USGS Idaho District (fig. 4.21).

Range Finder or Method for Estimating Distance to Shore

Edge discharges are estimated in the Transect software using a technique similar to that used when making conventional discharge measurements. The unmeasured area between the boat and the river edge is estimated using the last measured mean velocity, the last measured depth, and the distance from the boat to shore. The algorithm assumes a triangular-shaped area



Figure 4.16. Sea-chest mount for a narrow-band acoustic Doppler current profiler.

for this estimate. If the river channel is rectangular, these edge estimates can be doubled and an adjustment made for the roughness of the edges.

Estimating the distance to shore can be done with the naked eye; however, such distance estimates are almost always short of the true distance (under-estimated). The reason for this is unclear, but is possibly due to lack of visual clues between the boat

and shore. The most reliable way of ensuring accurate edge estimates is to set buoys out from the shore at known distances (measured with a tape or distance meter). The Transect software is then started and stopped at these buoys. This method is not always possible when large numbers of discharge measurements are needed at different locations within a short time period.



Figure 4.17. Mount used by the U.S. Geological Survey Tampa, Florida, Subdistrict.

There are several types of distance-measurement devices on the market that have been used to increase the accuracy of the edge estimates without the need to set buoys or onshore devices. The devices can be placed into three categories:

- Optical
- Sonic
- Infrared laser

Good results have been obtained with inexpensive, optical range finders (fig. 4.22) that use parallax and a focusing device to estimate distance. The operator identifies a rock or object at the stream edge

and then rotates a knob to converge two images of the object. The distance is then read from a scale on the device. This method requires a little practice but, with properly calibrated range finders, acceptable accuracy can be obtained up to about 180 m (600 ft).

Sonic devices that have been tried, require a vertical wall for a signal return. Riverbank edges generally do not have topographies that enhance acoustic reflections. To be usable, these devices need special sonic targets (corner reflectors) placed on the riverbanks. These devices can be useful if the operator

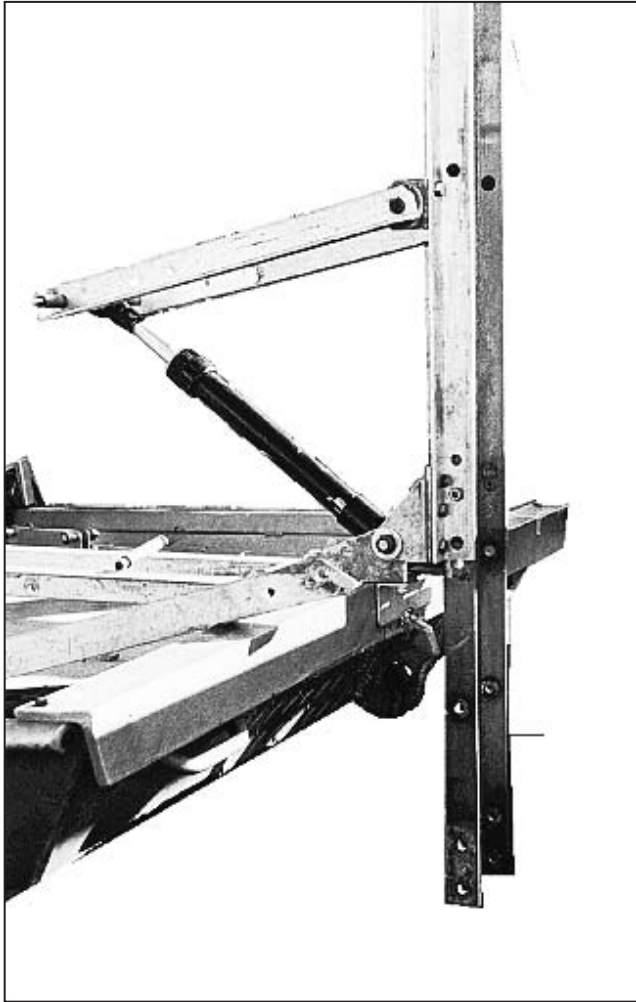

Figure 4.18. Hydraulic mount used by the U.S. Geological Survey Indiana District.

is able to deploy the sonic targets at the cross-section edges.

Laser devices are cumbersome and more delicate than the other range finders, but can be more accurate over longer distances. They can be used without targets (corner reflectors) up to about 75 m (250 ft) and up to

hundreds of meters (thousands of feet) with targets. The major drawback to these devices are their cost and durability. They require precision optics, which are delicate and easily damaged.

Trolling Motors/Plates

Discharge measurements typically require the use of slow boat speeds, especially in low water-velocity conditions. The main boat engine usually is too large for use when making discharge measurements. A battery-operated trolling motor (fig. 4.23) with variable speeds or a small gasoline-driven marine engine may be used to maneuver the boat at the slow speeds required for making a discharge measurement.

If an electric trolling motor is used, extra deep-cycle marine batteries should be included in the discharge-measurement equipment inventory. When using a trolling motor, a full day of discharge measurements may require two or more fully charged, deep-cycle marine batteries. If a gasoline-powered trolling motor is used, the operator may wish to purchase a four-cycle marine engine. A four-cycle engine is quieter than a two-cycle engine, does not smoke as much, idles for longer times at low speeds without spark plug fouling, and does not require an oil/gas mixture for operation.

Inexpensive steering adapters (fig. 4.24) can link smaller trolling motors to the main engine steering, and remote throttles and gearshifts also can be console mounted. Electric trolling motor steering even can be done with a foot pedal.

Miscellaneous Measurement Equipment

Miscellaneous discharge-measurement equipment may include the following:

- Buoys with attached anchors for marking cross-section edges
- Tag-line systems for measuring very slow velocities



Figure 4.19. “Toggle” mount used by the U.S. Geological Survey Kentucky District.

- External depth sounders and navigation equipment
- Rain/sun canopy and computer-protection gear

Installation of the Broad-Band Acoustic Doppler Current Profiler

Mounting the Acoustic Doppler Current Profiler on the Vessel

The ADCP is mounted on the measurement vessel using the mounting systems described

previously. In most cases, beam three is oriented toward the bow of the vessel, however, if the vessel will be measuring discharge next to bridge piers or vertical walls, the ADCP should be oriented such that the beams are at 45° angles to the axis of the vessel. This orientation allows the closest approach to the vertical wall.

Care must be taken to eliminate magnetic fields or ferrous materials from the vicinity of the pressure case. Not only the ADCP mounts, but all nuts, bolts, and other fasteners must be made from nonferrous materials.



Figure 4.20. Swing mount variation used by the U.S. Geological Survey Illinois District.

Deck-Unit and Power-Supply Connections

The other components of the BB-ADCP system also must be mounted or placed in safe (splash-free) areas on the measurement vessel. There are some precautions to be observed when installing the system components. The deck unit (if used) should be positioned out of direct sunlight (excessive heat) and away from exposure to moisture (the housing for the deck unit electronics is not waterproof). The deck unit should be opened and examined to ensure that all components (especially the DC-to-DC converter block) are firmly attached to the board socket by some means

other than electrical connector pins. The manufacturer has corrected this problem, but several of the early deck units had no mechanical attachments on the DC-to-DC converter block. The block would become dislodged during transportation and the deck unit would not function when connected to 12-volt DC power.

The connections on the back of the deck unit are shown in figure 4.25. Using the deck unit, the BB-ADCP may be powered with 110- to 120-volt AC power, 12-volt DC power, or 20- to 60-volt DC power. The AC power is supplied to the deck unit using a standard IBM personal computer-style pigtail



Figure 4.21. Detachable swing mount used by the U.S. Geological Survey Idaho District.

connection. The 12-volt DC power is supplied using a user-designed cable connected to the labeled terminal block on the back of the deck unit. Polarity is important when connecting to this terminal block using this cable connector. Early versions of the deck unit did not have input diode protection and could be damaged by improper DC polarity. The input polarity should be double checked before applying power. Most experienced BB-ADCP users begin a daily measuring session with two fully charged marine deep-cycle batteries. One fully charged 12-volt battery should



Figure 4.22. Optical range finders used to estimate near-shore distances.

power the BB-ADCP and computer for the whole day. The second battery is for backup.

A range of 20–60 V DC can be supplied to the deck unit through the bayonet style coaxial (BNC) connector (fig. 4.25). This voltage also must have proper polarity, as it is delivered directly to the BB-ADCP. The voltage must be supplied using a properly insulated (center positive) female BNC connector. **IMPORTANT!!!** These voltage magnitudes can be lethal, especially around water. Make sure all connections are insulated properly.

The voltage entering the 20- to 60-volt connector does not go through the DC-to-DC convertor before being sent to the BB-ADCP; therefore, it is not “stepped up” to the nominal BB-ADCP transmit voltage of 50. Voltages less than 30 may not supply the BB-ADCP with enough transmit power to enable profiling in the deeper depth ranges, especially if the water has few scatterers. Voltages greater than 60 may damage BB-ADCP power regulation components.

Acoustic Doppler Current Profiler Cables and Connectors

Broad-Band Acoustic Doppler Current Profiler

A multi-pin shell connector on the BB-ADCP cable connects to a 24-pin bayonet socket on the back of the deck unit. This connector assembly is not very



Figure 4.23. Typical battery-operated trolling motor used when making acoustic Doppler current profiler discharge measurements.

sturdy and should be protected from undue twisting and mechanical pressure. The overhang at the back of the deck unit prevents easy disengagement of the bayonet mechanism, and many operators only partially engage the mechanism to facilitate easy removal. A right-angle

shell connector can be ordered (when specifying the cable length) that may provide greater protection than the standard shell connector.

The molded underwater connector on the BB-ADCP end of the cable has a plastic alignment key that can become worn. Slight misalignment caused by wear of the alignment key can cause connector pins to bend when mating the connectors and tightening the locking ring. The O rings on both connector ends should be lubricated regularly with silicone grease and the connector rocked slightly to enable proper connector mating. If the alignment key or keyway is worn excessively, the connectors should be replaced.

It is possible that a long, coiled BB-ADCP cable can cause improper BB-ADCP operation. Noise or interference can be introduced (induced) into the coiled cable. Excess BB-ADCP cable should not be coiled, but flaked (using a non-overlapping S-shaped pattern) along the deck. It is best to order a short cable for use when the deck unit is mounted close to the BB-ADCP.

Workhorse Rio Grande

There is no deck unit for the Workhorse Rio Grande ADCP. Power is supplied to the electronics in the pressure case through a combination power and communications cable. The communications cable is terminated with a standard DB-9 RS-232 connector that mates with most laptop communication ports. The power cable is terminated with alligator clips that can be attached to a 12-volt battery. A users guide (R.D. Instruments, Inc., 1999) for connecting and configuring the Rio Grande is provided with the instrument or can be obtained from the RDI web site (www.rdinstruments.com).

Undoubtedly, other equipment will be needed that is unique to each operator or measurement site. Most operators build a “kit” containing ADCP measurement equipment, manuals, and field forms to be loaded before each deployment, thereby reducing the chances of forgetting to pack a vital piece of measurement gear.



Figure 4.24. Two views of a steering adaptor that connects the trolling motor to the main engine.

Summary

The acoustic Doppler current profiler (ADCP) discharge-measurement system consists of the following items:

An ADCP system with bottom-tracking capability

- Pressure case and transducer assembly
- Power supply and communications interface
- Discharge-measurement software

- Manufacturers' documentation

Ancillary equipment

- Safe measurement platform or vessel
- ADCP mounting assemblies
- Laptop computer
- Range finder or method for estimating distance to shore
- A knowledgeable ADCP operator and well-trained vessel operator.

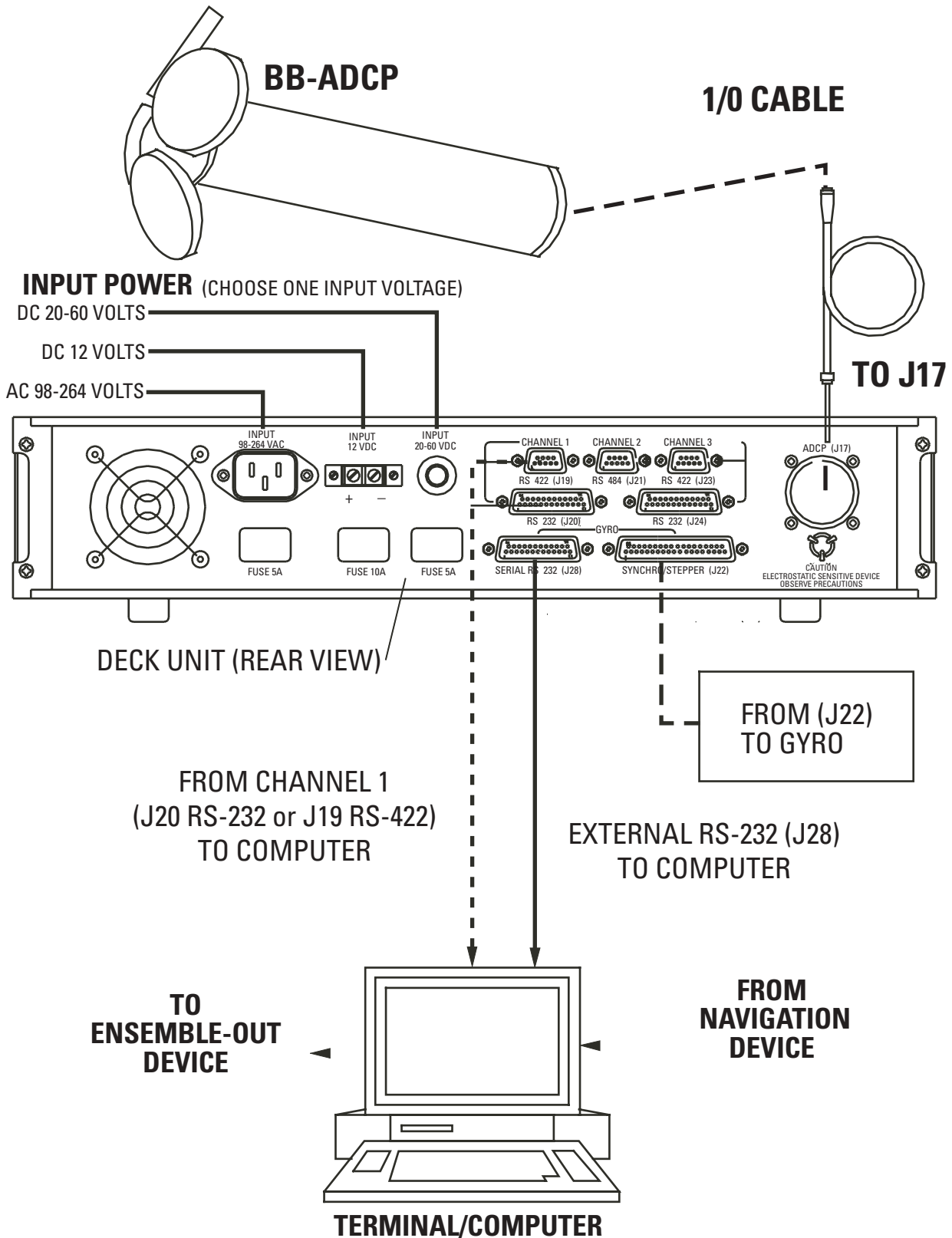

Figure 4.25. Interconnections of the broad-band acoustic Doppler current profiler (BB-ADCP) deck unit with other components of the acoustic Doppler current profiler discharge-measurement system. Adapted from R.D. Instruments, Inc., (1995). DC, direct current; AC, alternating current; V, volt.

This page left blank intentionally.

CHAPTER 5: BROAD-BAND ACOUSTIC DOPPLER DISCHARGE-MEASUREMENT SYSTEM CONFIGURATION

Discharge-Measurement Software—"Transect"

Although the BB-ADCP can be used as a velocity-profiling instrument, this report primarily addresses its usefulness as part of a discharge-measurement system. The purpose of this chapter is to discuss proprietary software used to configure the BB-ADCP or Workhorse Rio Grande and to acquire data from these ADCPs to measure discharge. This software is called "Transect." Most of the information covered in this chapter also can be found in the Transect Users Manual for the BB-ADCP (R.D. Instruments, Inc., 1995). This chapter will not dwell on the small details of configuring the BB-ADCP or Rio Grande, but will attempt to touch on the important issues and provide tips to the neophyte ADCP operator.

Transect is composed of a series of stand-alone software modules that incorporate the discharge-measurement algorithms discussed in chapter 2 and also include the following features:

- A graphical user interface
- Graphical output of ADCP velocity and discharge-measurement data
- Tabular output of ADCP velocity and discharge-measurement data
- Command and control interface to the ADCP
- Raw and processed data storage and playback

Transect also includes algorithms for estimating unmeasured parts of the water column and cross section. The Transect software has the ability to accept and record (along with the velocity data) external navigation and depth inputs.

Transect Configuration

The configuration file is at the heart of the Transect software. The configuration file can be thought of as the interface between the ADCP and the Transect software modules. Commands in the configuration file tell the Transect software how to communicate with the ADCP, how to configure the ADCP, and how to modify the ADCP data-collection parameters for proper discharge measurement. It is possible to use the communication, calibration, and planning modules of the Transect software to build a trial configuration file on the basis of rough stream parameters. Although this method is used below to illustrate some of the modules in the Transect software, it is recommended that neophyte operators obtain

preliminary configuration files from ADCP training classes or the USGS Office of Surface Water ADCP users' group Web site (<http://il.water.usgs.gov/adcp/>). Experienced users usually bypass the Transect communication, calibration, and planning modules and directly modify preexisting configuration files using a text editor to fit the desired stream conditions.

To familiarize the reader with the Transect communication, calibration, and planning modules, we will first discuss a method for creating a preliminary configuration file, and then discuss each section of the configuration file, in detail.

Creation of a Preliminary Configuration File Using Transect Modules

Communications Setup

The Transect software provides a communication test and setup whereby the user can establish communication with the BB-ADCP processor. The user also can use any terminal-emulation software or the software supplied by the manufacturer called "BBTALK" to establish communication with the BB-ADCP. BBTALK is a simple terminal emulator with file-capture capability that can be used to initially check the BB-ADCP communication parameters if the Transect software cannot establish communication.

Instructions for using the emulator are in a disk file called 'BBTALK.DOC' that is shipped with the Transect software utilities. If the operator cannot establish communication with the BB-ADCP, then the BB-ADCP technical manual should be consulted and the communications and power connections should be double checked. Different baud rates and bit combinations can be tried on a trial-and-error basis in the event that the BB-ADCP was setup on a nondefault baud-rate/bit combination. This will be practical only for semistandard parity bit and stop bit combinations (for example, no parity bit, eight data bits, one stop bit). It is possible to set the BB-ADCP to a nonstandard baud rate with a combination of stop bits and parity that is difficult (if not impossible) to determine by trial and error. If all standard methods produce "garbage" output to the BBTALK screen, the ADCP should be disassembled and the master reset button on the CPU board should be pushed (R.D. Instruments, Inc., 1995–1999). This will reset the BB-ADCP to factory default communication values. This should, however, be done only after the failure of all other attempts to establish communication with the ADCP.

By using the BB-TALK terminal emulator (fig. 5.1), the operator can invoke the BB-ADCP diagnostics menu with the PT command. PT0 displays

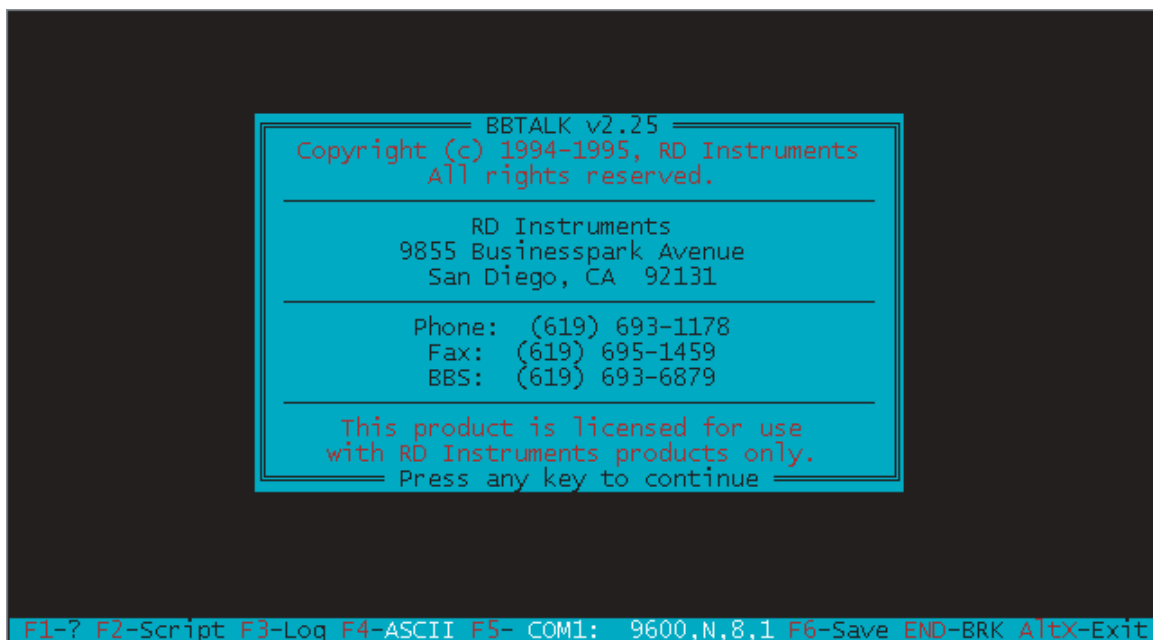

Figure 5.1. BB-TALK terminal emulator help screen.

the test menu. PT200 performs an entire suite of diagnostic tests. The BB-ADCP technical manual provides a detailed description of the diagnostic tests. Parts of the PT200 diagnostic test often will indicate failure if the ADCP transducer assembly is not immersed in water. In fact, certain parts of the PT200 diagnostic test may fail (with a healthy ADCP) if the transducers are immersed in a shallow bucket of water that is placed on a hard surface.

For best results, the diagnostic tests should be performed at the river cross section with the ADCP immersed in water. If the tests must be done in the office or lab, the transducer surfaces should be cleaned with soap and water (to remove grease), and then immersed in a plastic pail of water sitting on a foam pad. The manufacturer should be called if the BB-ADCP fails any of the PT200 suite of diagnostic tests using this scenario. Discharge measurements should not be done if the diagnostic tests indicate a failed subsystem. A PT200 test should be done before every discharge-measurement series, and the test output should be captured to a file and archived.

The communications menu selection of the Transect software main menu (fig. 5.2) allows the operator to establish communication with the BB-ADCP, provides the proper communication parameters for the construction of the configuration file, and provides access to direct (terminal emulation) communication with the BB-ADCP for checkout, configuration, and debugging of configuration

problems. The communications parameters established in a session using the communication submenu are added to the communication section of the configuration file.

The communications ADCP submenu (fig. 5.3) provides for the setup and checkout of initial BB-ADCP communication parameters. Once these parameters have been determined, the trial configuration file can be saved with these parameters included. The communication menu also provides for the setup of communications between navigational devices, external readouts, and the external sensors (if any are required). The setup of these devices is covered in detail in the Transect software documentation (R.D. Instruments, Inc., 1999) and is not covered in this report.

Calibration Setup

After establishing communication with the BB-ADCP (and, thereby, setting up communication parameters in the configuration), the operator then should go to the calibration submenu for the next level of configuration file construction. In the calibration menu within the main menu (fig. 5.4), two submenus (offsets and scaling) will help create a “trial” configuration file when saved.

The calibration offsets submenu (fig. 5.5) provides the operator with the opportunity to set the BB-ADCP time and to enter compass alignment offsets (if the compass is separate from the BB-ADCP) or to enter compass magnetic corrections.

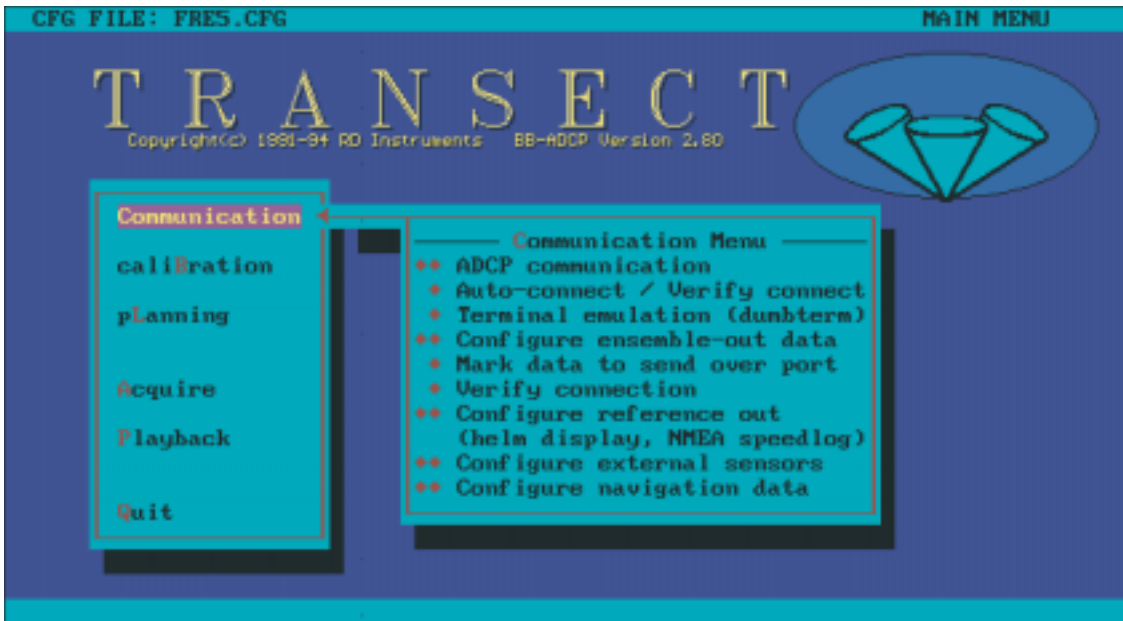

Figure 5.2. Transect main menu showing menu choices. BB-ADCP, broad-band acoustic Doppler current profiler.

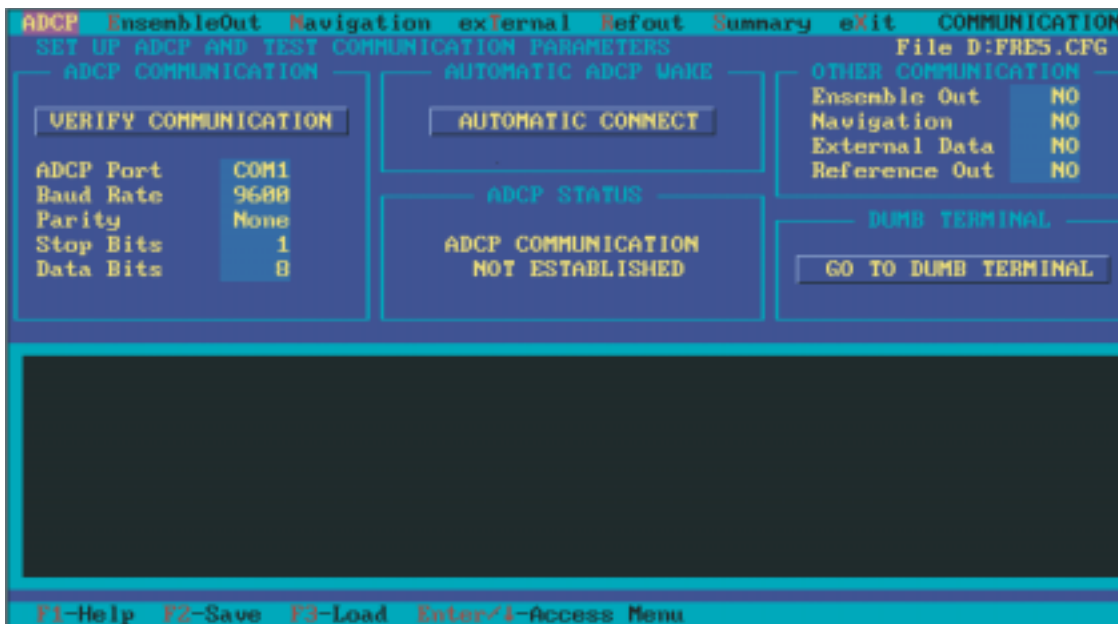

Figure 5.3. Communication acoustic Doppler current profiler (ADCP) submenu.

The next menu entered should be the calibration scaling submenu (fig. 5.6). The calibration scaling submenu provides the operator with the option to change several important velocity-profile scaling and estimation parameters. If salinity at the measurement site is known, or can be accurately estimated, it can be entered in this menu. Speed of sound can be entered manually if it is known, but, in almost all cases, should be computed for each ensemble. The discharge extrapolation scheme should be left at “power” for the

top estimation method, and “power” for the bottom estimation method, unless examination of the profiles indicates that these values should be changed or bidirectional flow exists in the measurement cross section. The power-curve exponent also should be left at 0.16670, unless otherwise indicated (chap. 8). Pitch and roll compensation should be left at the default setting of YES, which allows the Transect software to automatically compensate for vessel pitch and roll during the discharge measurement. The absorption

coefficient and echo intensity scale also should be left at default values, unless otherwise indicated. The value of these parameters has no effect on discharge- or velocity-measurement results. The configuration file should be saved with the appropriate name upon exiting the calibration menu.

Planning Setup

The next main menu is the planning menu (fig. 5.7). The planning menu, has two submenus (set and ADCP) that, when used properly, will complete the initial creation of the configuration file.

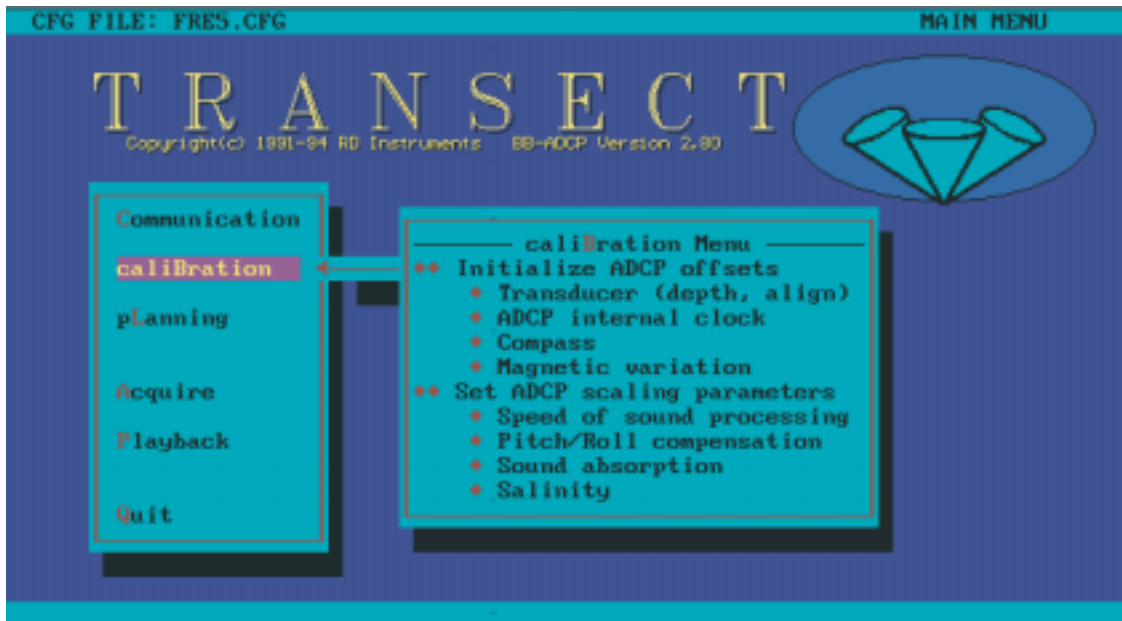

Figure 5.4. Transect main menu showing calibration menu choices. BB-ADCP, broad-band acoustic Doppler current profiler.



Figure 5.5. Calibration offsets submenu screen. ADCP, acoustic Doppler current profiler

The planning setup submenu (fig. 5.8) prompts the operator for the deployment name, primary drive, secondary drive, recorded data types, measurement processing, and engineering units used for tabular and graphics output. If an operating frequency for the ADCP has not been specified, the setup menu will prompt the operator to provide an entry.

The deployment name should be a unique, four-letter identifier for the measurement site. For example, the identifier FRES could be used for Sacramento River at Freeport, California, session 5 (fig. 5.8). Future releases of Transect may support the use of a longer identifier. The deployment name has two functions; it becomes the name of a MS DOS root-level directory



Figure 5.6. Calibration scaling submenu screen. ADCP, acoustic Doppler current profiler.

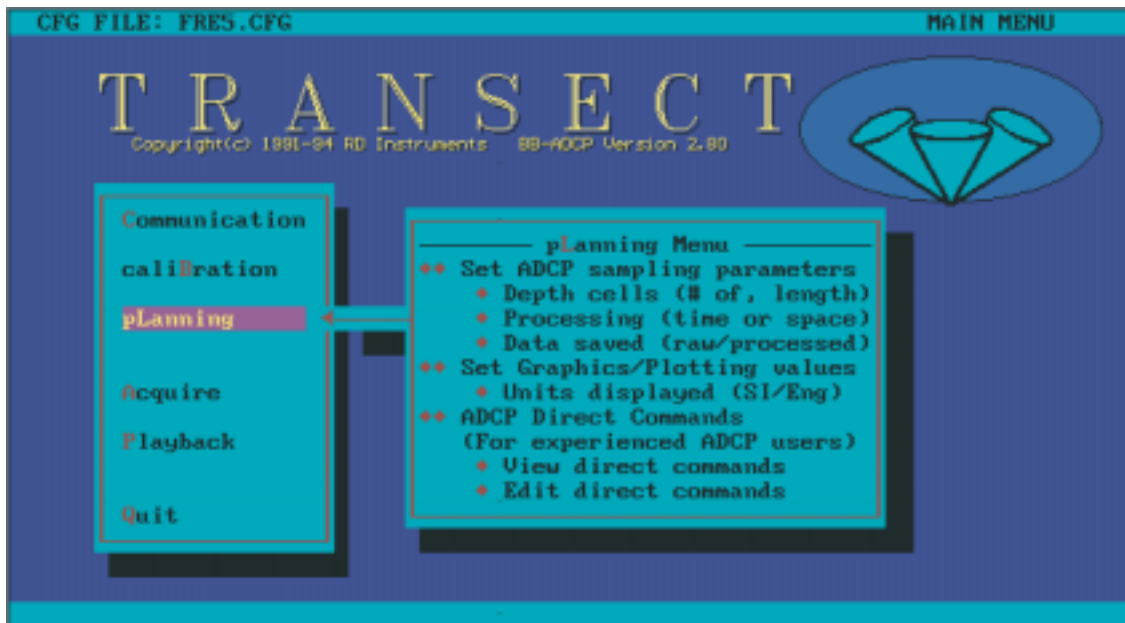

Figure 5.7. Transect main menu showing planning menu choices. BB-ADCP, broad-band acoustic Doppler current profiler.



Figure 5.8. Planning setup submenu screen. ADCP, acoustic Doppler current profiler.

where all ADCP data collected with this configuration will be stored and it also forms the first four characters of each filename of ADCP data.

The primary and secondary drives in the setup submenu are usually the same and are used to construct the data storage path name. For example, data from the above example would be stored in the FRE5 directory on the C drive (C:\FRE5). The secondary drive is used in cases where the Transect software runs out of storage space on the primary drive. When hard disk space is limited, the secondary drive can be changed to indicate another hard disk or a floppy drive.

Data recorded with Transect may be stored in three different types of files: raw, processed (averaged), and navigation. Raw data always should be recorded for USGS discharge measurements. These data provide the operator with the ability to “play back” any discharge measurements that were recorded from unprocessed BB-ADCP data-output files. Processed data can be recorded if additional information needs to be stored during the discharge-measurement series. Raw data files contain unmodified data recorded directly from the ADCP. Processed data files typically contain averaged ADCP data, but also may contain data from an external navigation device, configuration-file data, and estimates of edge discharges.

Navigation data should not be recorded unless the BB-ADCP is connected to external navigation devices such as GPS or Loran C systems. The recording and processing of navigation data requires a recent version of the Transect software (4.00 or later) to

execute properly. This report will not cover the operation of external navigation interfaces.

The processing selection (fig. 5.8) controls data averaging done by the Transect software (not in the BB-ADCP) and is used for processed data output. The raw ensemble data can be averaged with time (traverse time) or space (cross-section distance). This setting will affect the number of ensembles that are displayed during a cross-section traverse but will not affect the recording of raw ADCP data. The averaging of raw data is affected by the number of measurement pings averaged by the ADCP firmware (discussed in chap. 6).

The graphics and tabular displays can be annotated in either standard or metric units. This setting does not affect the raw data.

The planning ADCP submenu (fig. 5.9) allows the operator to input ship speed and the length of transect, and then provides the operator with a display of estimated transect time, first and last depth-cell positions, time between ensembles, and standard deviation of individual ensemble velocity averages. The operator also is informed of the amount of available disk space and disk space required for the transect.

If the operator has saved the configuration file at each of the above described menu steps, a configuration file has been created, much like the one in figure 5.10.

The Configuration File, in Detail

As explained in the previous section, the ADCP configuration file is used by the Transect software to communicate with, configure, and control an ADCP.

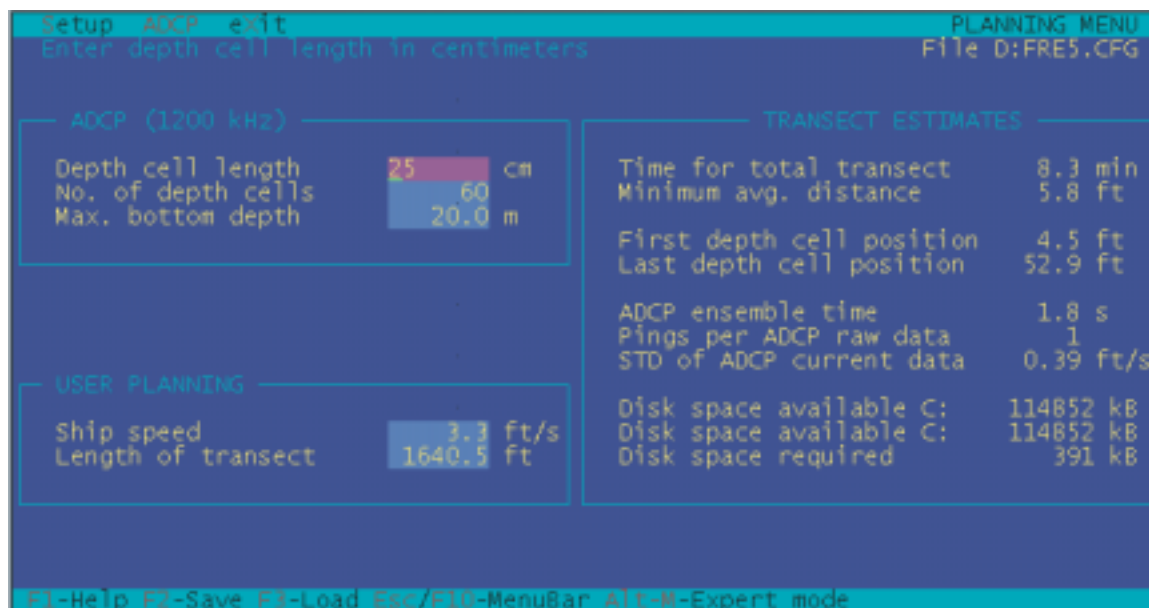

Figure 5.9. Planning acoustic Doppler current profiler submenu screen. ADCP, acoustic Doppler current profiler.

The configuration file also controls the type of data collected and where the data are stored on the host computer. Configuration files are standard text files that can be opened with a generic text editor.

The first line of a configuration file verifies that this is an official RDI configuration file and must be present for proper loading. If the line becomes altered or corrupted, the operator will get a message that reads “the file is not a Transect configuration file.” If the above described error occurs, the line can be corrected (with the exact text shown in fig. 5.10) using a text editor.

The configuration file consists of the following sections:

- The communications section
- The calibration section
- The recording section
- The ADCP hardware section
- The direct command section
- The processing section
- The graphics section
- The history section

Each section of the configuration file addresses different aspects of ADCP command and control, as well as Transect software data storage and visualization. We will discuss each section of the configuration file in detail in the following paragraphs. Sections within the configuration file are enclosed in braces.

The Communications Section

The first section is the communication section, which sets up the Transect software to “talk” with the ADCP. The section contains directives in the form

```
Device 5sp (Switch sp Port sp Baud-rate sp
Paritybits sp Databits sp Stopbits) [port baud
parity databits stopbits]
```

where

sp = space.

Items in parentheses should be edited to match the device configuration. Items in brackets are reminders or comments and should not be changed. For example, if an ADCP were setup to communicate at 38,400 bauds per second with no parity, eight stop bits, and one data bit through the COM1 port of a computer, the first directive line would read: ADCP (ON COM1 38400 N 8 1) [Port Baud Parity Databits Stopbits].

There are directives for all allowed devices that might communicate with the Transect software through the various computer ports. The ADCP directive line is mandatory; however, the other directive switches should be turned off unless needed (fig. 5.10). These directives also can be set from the communication menu in the Transect software.

Ensemble Out Section

The ensemble out section (fig. 5.10) contains a series of toggles that enable or disable output of the various ensemble data. If the ENSOUT directive in the communication section is ON, then information from

BEGIN RDI CONFIGURATION FILE — This line must be first in all RDI configuration files

COMMUNICATIONS — Begin communication section

```
{
  Switch Port      Baud  Parity  Databits  Stopbits
ADCP — A Must    ON   COM1    9600    N        8        1 — Must be set to ADCP rate
ENSOUT           OFF  COM2    9600    N        8        1

NAV — This is for OFF  COM3    9600    N        8        1
  GPS or Loran
REFOUT           OFF  COM4    9600    N        8        1
EXTERNAL         OFF  COM5    9600    N        8        1
UseSoftwareBreak (NO) — This is set to yes when using a radio modem.
}
```

ADCP HARDWARE

```
{
Firmware      (5.57)
Angle         (20)
Frequency     (1200)
System        (SHIP)
Mode          (1)
Orientation   (DOWN)
Pattern       (CONVEX)
}
```

This section (ADCP hardware) will fill with pertinent information when you start the acquire program (see text). If you have set these values incorrectly, you will receive a warning message after the ADCP responds.

Figure 5.10. Communication, ensemble out, and acoustic Doppler current profiler (ADCP) hardware sections of the configuration file. RDI, R.D. Instruments, Inc.; GPS, global positioning system.

each ensemble is transmitted from the selected computer port. This section normally is not used for ADCP discharge measurements. Details for obtaining real-time ensemble data are available in the Transect software manual (R.D. Instruments, Inc., 1995). The ensemble out section also can be set up from the communications menu in the Transect software.

Acoustic Doppler Current Profiler Hardware Section

The ADCP hardware section (fig. 5.10) is a list of parameters that describe the ADCP hardware configuration. These parameters are not actually transmitted to the ADCP but are checked against actual ADCP hardware parameters upon ADCP “wake up.” Missing parameters are filled in to match ADCP hardware. If the Transect software discovers a discrepancy between parameters in the configuration file ADCP hardware section and configuration data transmitted by the ADCP, a warning is displayed.

Additional information regarding this check is given later in this chapter.

Direct Commands Section

Direct commands are commands interpreted by the ADCP, much like a computer operating system interprets commands issued by a user. Direct commands can affect the outcome of a discharge measurement, therefore, it is imperative that the ADCP operator fully understand the purpose and outcome of the basic direct command set. The direct commands section is the most important part of the configuration file (fig. 5.11). Some direct commands are mandatory for proper discharge measurement. Erroneous commands can cause improper operation of the ADCP. The most important of the direct commands are the water- and bottom-mode commands (WM, WV, and BM). These commands were discussed in chapter 3, and are not discussed here.

Some direct commands may be controlled from menus within the Transect software. Direct commands are discussed in detail in the technical manuals for the BB-ADCP, Rio Grande, and narrow-band ADCP (R.D. Instruments, Inc., 1995–1999) and many of them are not referenced in this report. However, an understanding of the most important commands is required for proper creation of configuration files.

Direct commands, like all other BB-ADCP parameters, can be edited into the configuration files without using the Transect software menus. However, the expert mode (alt-M) in the ADCP planning sub-menu provides an easy way to enter direct commands into the configuration file. This mode allows the operator to specify the direct commands that will be sent to the BB-ADCP during Transect initialization (fig. 5.12).

DIRECT COMMANDS — Direct command section: These commands are very important and are covered in detail later in chapter 5 of this report.

```
{  
WS25 — Bin size  
BX300 — Bottom-track depth  
WNXXX — Number of water-measurement bins  
WF50 — Blanking distance  
WV170 — Mode 1 ambiguity velocity  
WZ5 — Mode 5 lag  
WD111100000 — Output data types  
WM1 — Water mode 1 — Number of bottom pings  
WP5 — Number of water pings  
BP4 — Number of bottom pings  
BM5 — Bottom-track mode  
TP000006 — Time between pings  
EX10111 — Coordinate transformation flags  
ES0 — Salinity  
}
```

RECORDING — Beginning of the ADCP recording setup section

```
{  
Deployment (FRE5) — Unique four-letter deployment name  
Drive 1 (C) — Primary data storage drive  
Drive 2 (C) — Secondary (or emergency) data drive  
ADCP (YES) — Set YES to record ADCP data (a MUST)  
Average (NO) — Averaged data are not usually recorded  
Navigation (NO) — Set to No external GPS data are recorded  
StartRecording (NO) — Set to yes to turn recording on by default  
when Transect is first started.  
}
```

Figure 5.11. Direct command and recording sections of the configuration file. ADCP, acoustic Doppler current profiler; GPS, Global Positioning System.

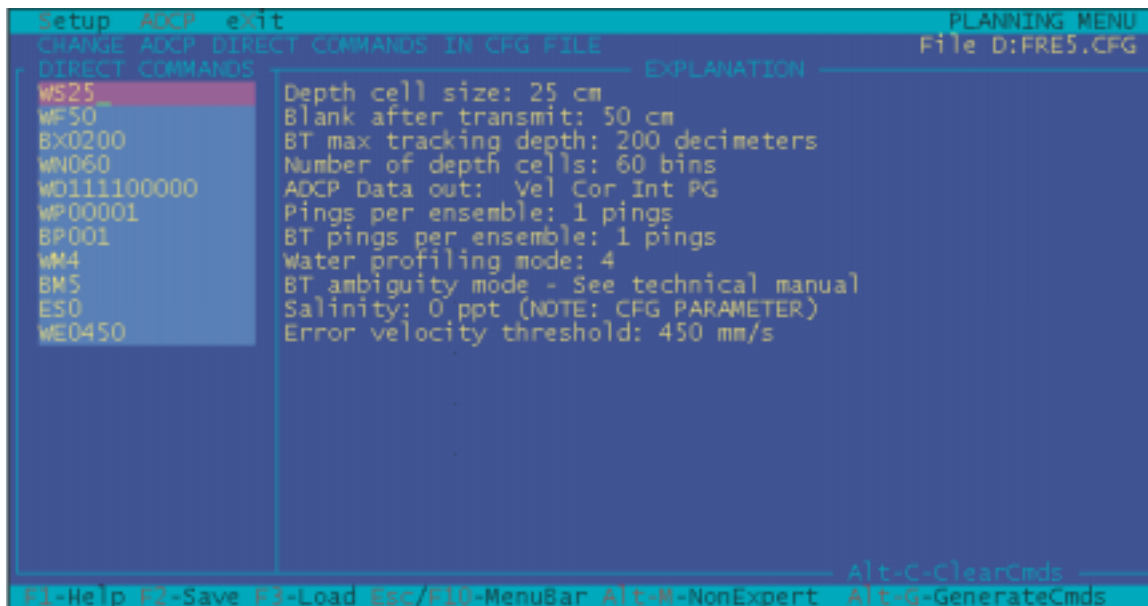

Figure 5.12. Planning acoustic Doppler current profiler (ADCP) menu in expert mode (Alt-M).

The direct command numeric arguments are set by the manufacturer and are in metric units. To avoid confusion, standard-unit conversions will not be presented in the following discussion. All direct commands listed in the technical manual are important; however, some are set by default and almost never change, some are not changed except under rare conditions, and some are changed dynamically by the instrument. Some direct commands must be changed by the operator for optimum BB-ADCP operation in changing environments and are discussed below.

When discussing the direct commands, the syntax for each command will be shown as CCnnnn, where CC is a two-letter command; and nnnn is an integer parameter. For example, the water ping command will be referred to as WPnnnn, where nnnn is the number of water pings averaged for a data ensemble.

Water-Track Commands

WSnnn

WSnnn is the command used to set the length, in centimeters, of the depth cell used for water-velocity measurement (0–999), and controls the vertical resolution of the measured-velocity profile. In most cases, this value of WS can be determined using table 5.1

These settings provide the best resolution in the event that velocity profile information must be extracted from the discharge measurement. By default, these values are placed in the direct command section

when a new configuration file is created with the ADCP frequency specified. In some cases, these values may have to be changed (in very deep or very shallow water, for example). Consult the BB-ADCP technical manual before doing so. The WS parameter also may be set in the planning menu of the Transect software.

WNnnn

WNnnn is the command used to set the number of water-velocity measurements (depth cells) in the vertical profile, and can have a numeric range of 1–128. This value should be set so that WS multiplied by WN exceeds the maximum expected depth in the cross section by a safe margin. CAUTION! Failure to properly set this parameter can cause loss of discharge-measurement accuracy, loss of vertical resolution, and incomplete velocity profiles. This parameter also can be set using the planning menu in the Transect software.

WPnnnn

WPnnnn is the command that sets the number of water-velocity measurements (pings) that are averaged together to form a data ensemble (range from 0 to

Table 5.1. Optimum bin size (WSnnn) for acoustic Doppler current profiler (ADCP) discharge-measurement applications

ADCP water mode	WSnnn for 1,200-kHz ADCP	WSnnn for 600-kHz ADCP	WSnnn for 300-kHz ADCP
Mode 1	25	50	100
Mode 5	5	10	20
Mode 8	5	10	20

Bottom-Track Commands

BA_{nnn}

6384). As a general rule it is recommended that this value be set to 1 because if an ambiguity error occurs, it will not be averaged with other pings and therefore can be readily identified. If data are averaged by using a WP command greater than 1 and an ambiguity error occurs in one of the ensembles, it will be averaged along with the good pings and will cause a bias error that may not be recognized when the data are played back. In situations where many ambiguity errors occur, the discharge measurement will be biased. This bias can occur using water modes 5 and 8 and sometimes is seen using mode 1 during dynamic conditions.

BA_{nnn} is the bottom-track evaluation amplitude minimum (1–255 counts). This command defaults to 30, but can be changed to 25 when bottom movement is suspected. Values lower than 25 should not be used because of the possibility of velocity-measurement contamination by sediment moving above the bottom. When bottom-sediment movement is present, using lower frequency ADCPs (300- or 600-kHz) may sometimes help eliminate bottom-movement bias (chap. 3) (example BA25).

BC_{nnn}

In some cases during low-flow measurements, when using mode 1, a modest number of pings can be averaged to help reduce the standard deviation of the discharge measurement. Averaging pings in the ADCP by using a non-zero WP command can increase the total number of pings collected during a discharge measurement because the ADCP firmware processes data faster than the Transect software. However, using a non-zero WP command is dangerous (because of the possibility of disguised velocity ambiguities) and should be used with caution.

BC_{nnn} is the bottom-track correlation magnitude minimum (1–255 counts). The BB-ADCP flags any data having a correlation magnitude less than this value as bad data—perfect correlation (solid target) is 255 counts and the default value is 220 counts. This value can be set slightly lower when bottom tracking is difficult to acquire (example BC210).

BP_{nnn}

WF_{nnnn}

WF_{nnnn} is a command used to set transducer blanking distance (range 0–9999 cm); the blanking-distance command defines the regions near the transducer faces where no velocity data should be collected. Depth cells close to the transducer faces may be corrupted because transmitted energy has not completely dissipated from the electronics or transducer ceramics. If this command is set too low, it may cause corruption of the first measured velocity bin. This corruption can be very hard to detect. For 1,200- and 600-kHz BB-ADCP units, the recommended minimum setting for this value is 50 for mode 1 and 30 for modes 5 and 8 operation. For Rio Grande units, the recommended setting for this value is 25 for all modes. Minimum recommended values for this parameter also depend upon operating frequency.

BP_{nnn} is the number of bottom pings that are averaged for each data ensemble (1–999 pings). This value should be set to the same value as that of the WP command, or one less than the WP command if more than one water ping is averaged for each data ensemble (example BP01).

BX_{nnnn}

WD_{nnn nnn nnn}

WD_{nnn nnn nnn} is the water-data output from the BB-ADCP. The toggles for these parameters are set to 1 or 0 (1 = enabled, 0 = disabled) for the following data: velocity, correlation, intensity, percent good, status, and P0, P1, P2, and P3 (Px = external parameter data 0–3). For example, WD11110000 outputs velocity, correlation, intensity, and percent good.

BX_{nnnn} is the maximum bottom-track search depth, in decimeters [80–9999 decimeters (dm)]. This value should be set to match the deepest expected depth plus a safety factor. CAUTION! Error in this parameter in water deeper than 8 m can cause loss of bottom track and invalid discharge measurements because of missing ensembles. This parameter is set in decimeters, rather than centimeters, and, therefore, is more prone to operator setup errors (example BX100).

&R_{nn}

The &R_{nn} command, while not a standard bottom-track command, must be set properly in the BB-ADCP because the default setting is not optimized for river discharge measurement. The value nn is the length of the bottom-track pulse, in percent of total depth. In BB-ADCP firmware, the default for this is 30 (30 percent). The manufacturer suggests that a value of 20 (20 percent) is more applicable to riverine environments. The recommended setting for this command is &R20, and it should be included in the direct commands section of the configuration file so that the default value is overwritten.

General Commands

ESnn

ESnn is the estimated salinity, in parts per thousand (0–40). It is important to set this parameter properly because the BB-ADCP default setting is for open ocean (ES35), which can cause discharge-measurement errors in freshwater if undetected. An ES0 command is necessary in the configuration file if measuring freshwater. Salinity in brackish or oceanic waters should be measured with a salinimeter. Unless the salinity is known, this command always should be set for zero salinity (ES0) because the value can be changed after the fact in the Transect calibration section (if it is discovered that brackish water was present, for example). If the value is set to the wrong salinity (other than 0) in the direct command section, it is much harder to correct the resulting discharge values.

EXnnnnn

EXnnnnn is the set of coordinate transformation flags, where each n in the command is set to a 1 or a 0, according to the following encoding scheme:

- EX00nnn = no transformation (beam coordinates)
- EX01nnn = instrument coordinates
- EX10nnn = ship coordinates
- EX11nnn = Earth coordinates
- EXnn1nn = uses tilts (pitch and roll) in transformation
- EXnnn1n = allows three-beam solutions if one beam is below WC threshold
- EXnnnn1 = allows bin mapping

This command allows the BB-ADCP to transform beam coordinates into other coordinate systems. The Transect software can do the above transformations if radial-beam velocities (beam coordinates) are recorded (the default mode). For robust operation, the BB-ADCP probably should be set for ship coordinate transformation because the data are transformed in the Transect software rather than adjustments made to the raw recorded data.

If velocity profiles are required, it is preferable to collect raw data in beam coordinates because of the difficulty in changing coordinate systems after conversion to Earth coordinates. (It is difficult to “back out” raw-beam coordinates if there is no ping-by-ping record of the corrections for pitch, roll, and heading.)

When recording in ship or beam coordinates while averaging ensemble data in the profiler, pitch, roll, and sharp boat movements and heading changes should be kept to a minimum. Corrections for these events are calculated by the Transect software at the end of the ensemble (not for each ping). For example, if

averaging is set to five water pings and five bottom-track pings per ensemble and beam coordinate transformation is selected, coordinate transformation and pitch and roll correction will not occur until the averaged ensemble is transmitted to the computer from the ADCP. In the above case, the transformation and correction occurs at the end of a 4- to 5-second interval. If the boat has pitched or rolled significantly during the 5-second period, the correction may be applied incorrectly or not applied at all. For velocity coordinates, the Transect software calculation is not affected by the coordinate system being used, however the software does require exact synchronization between the bottom-track vector and the water-track vector. If both coordinates are Earth transformed at the end of a 5-second interval and there are abrupt heading changes during the interval, the synchronization of these vectors may not be achieved because of time/phase lag in the onboard flux-gate compass. For these reasons, despite the lower ADCP ping-rate performance, the WP and BP commands probably should be set to average 1 ping for each data ensemble (WP01 and BP01) in windy conditions or conditions with a significant amount of pitch and roll.

Another reason for setting WP and BP to 1 is so ambiguity errors (chap. 3) will be more apparent. If data are averaged along with an ambiguity error, the error could be masked because of the averaging. This can be especially devastating in mode 5 because ambiguity errors are more likely to occur.

Pitch and roll corrections should be applied, unless the tilt sensors are defective. If tilt sensors are transmitting invalid data, they can be disabled to collect discharge data.

In most cases, three-beam solutions always should be enabled so that velocities can be calculated in the event that data are lost from one beam, however, there is some controversy as to the proper setting for three-beam solutions. Please check the USGS ADCP users web site (<http://il.water.usgs.gov/adcp/>) for late-breaking instructions.

Bin-depth mapping should be enabled so that the measurement bins are kept at the same depth for each beam during a pitch and roll event.

For example, an EX00111 command does no coordinate conversion (beam coordinates, uses pitch and roll in the transformation, allows three-beam solutions for missing beams, and allows bin-depth mapping for pitch and roll).

Recording Section

The recording section of the configuration file (fig. 5.11) contains information that is used by the

Transect software to set up the data recording paths, as well as specifications for drive priority, averaged data recording, and navigational data recording. Required sections are as follows:

- Deployment (cccc), where cccc is a four-character file name to be used as a prefix for the data file. For example, if the operator picks deployment (TUFA), resulting file names will be TUFA001r.000, TUFA002r.000, and so forth. The deployment name and configuration file name should be the same to keep the correct configuration file synchronized with the correct data set (version 2.72 and earlier). Version 2.80 (and later) of the Transect software stores a configuration file with each transect, thereby eliminating the synchronization problem.
- Drive 1 (d) where d is the path name for the primary data-storage drive. For example, if drive C:\ is the primary data drive, then the proper directive is drive 1 (C).
- Drive 2 (d) where d is the path name for the secondary data-storage drive. For example, if drive C is nearly full and is the primary data-storage drive, the Transect software will automatically switch to the secondary storage drive upon filling C drive with data. If a formatted floppy disk is placed in drive A for such an emergency, then the proper directive would be drive 2 (A).
- ADCP (YES/NO) specifies that the Transect software record (or not record) ADCP raw (unaveraged) data. This always should be set to YES.
- Average (YES/NO) specifies that the Transect software record (or not record) averaged data. This directive usually is set to NO, unless the operator wishes to record averaged data. Because raw data can be averaged on playback, this directive usually is not needed, even if averaged data are desired.
- Navigation (YES/NO) specifies that the Transect software record (or not record) external-navigation data. This is set to YES if external-navigation data from Loran C or GPS systems are to be recorded with each ensemble. Any external RS-232 data can be recorded in this manner and synchronized with the ADCP data.

Calibration Section

The calibration section of the configuration file (fig. 5.13) contains important information that supplies the Transect software with data that are vital to proper

coordinate transformation and discharge calculation. Note that these data can be changed upon playback and are not part of the raw data file.

- ADCP depth, in meters, is the draft (depth below water surface) of the ADCP transducer faces. This parameter is used by the Transect software to calculate the depths at the bin centers and is vital to the proper calculation of the curve fit estimation data as well as subsection depth.
- Heading/magnetic offsets are values that are primarily used to correct the internal flux gate compass of an ADCP to true north. One parameter adjusts for magnetic anomalies (such as metal objects), whereas the other adjusts for magnetic declination obtained from navigational charts or maps.
- Transducer misalignment is a value that is nonzero only when the compass is separate from the transducer assembly. This value is used to correct the azimuth of the transducer assembly to the azimuth of the compass (in degrees), and is primarily used with gyroscopic-based heading systems.
- The intensity and absorption values are scale factors used to correct the raw, backscattered intensity counts from the ADCP into decibel values corrected for receiver gain and range. The intensity scale factor is used to convert raw counts to decibels and should be left at the default value unless other values are indicated. From the calibration menu, the absorption value can be set to a default value, set to a known value, or calculated by the Transect software as a function of frequency, water temperature, and salinity. All three choices can be made from the Transect calibration software by tabbing to the appropriate selection in the sound absorption coefficient part of the scaling submenu.
- Salinity should be set to the measured or estimated salinity at the measurement site.
- Speed-of-sound correction and pitch-and-roll compensation normally should be set to YES, unless the temperature or tilt sensors are providing erroneous data.
- Tilt misalignment, pitch offset, and roll offset normally are set to zero unless the tilt sensors are mounted external to the ADCP case.
- Top discharge estimate can be set to POWER or CONSTANT. If it is set to POWER, then the Transect software uses the power-curve coefficient to estimate velocities in the unmeasured area near the water surface. If it is set to CONSTANT, then the Transect software

CALIBRATION — ADCP calibration section (discussed in detail in chapter 5 of this report).

```

{
ADCP depth (0.16 m) — ADCP draft (distance below water surface).
DBTDraft (0.00 m) — Depth sounder draft (if an external depth sounder is used).
Heading / Magnetic offset (0.00 10.00 deg) — For setting compass alignment to
true north.
Transducer misalignment (0.00 deg) — For aligning compass to ADCP (if compass is
separate).
Intensity scale (0.43 dB/cts) }
Absorption (0.278 dB/m) } Normally left at default values.
Salinity (0.0 ppt) — Set to correct salinity value here (or zero if in doubt).
Speed of sound correction (YES) }
Pitch & roll compensation (YES) } Normally set to YES.
Tilt Misalignment (0.00 deg) }
Pitch_Offset (0.000 deg) } Normally set to 0.00 unless the tilt sensors are mounted
Roll_Offset (0.000 deg) } external to the ADCP case.
Top discharge estimate (POWER) }
Bottom discharge estimate (POWER) } Normally set to POWER.
Power curve exponent (0.1667) — Normally set to 0.1667 unless the velocity profiles appear
to be nonstandard.
}

```

Figure 5.13. Calibration section of the configuration file. ADCP, acoustic Doppler current profiler.

uses the same cross product as is used for the uppermost measured bin to estimate near-surface, unmeasured discharge. Chapter 8 contains a discussion on how to examine the measured profiles to determine the proper estimation technique.

- Bottom discharge estimate can be set to POWER or CONSTANT. If it is set to POWER, then the Transect software uses the power-curve coefficient to estimate velocities in the unmeasured area near the channel bed. If it is set to CONSTANT, then the Transect software uses the same cross product as is used for the bottom-most measured bin to estimate near-bottom, unmeasured discharge. Chapter 8 contains a discussion on how to examine the measured profiles to determine the proper estimation technique.

- Power-curve exponent usually is set to 0.1667 for a “Manning-like” water-velocity profile. Under most conditions, this value should be set to the one-sixth power setting (0.1667), even in the estuary. A good test of this value is to pick a transect and average a series of ensembles in the deeper, faster part of the cross section. The averaged profile then should be then viewed from the discharge profile plot in the Transect software playback menu. If the plotted power curve fits the data points, the one-sixth exponent value can be used. If the plotted power curve does not fit the data, other exponent values can be tried until a good fit is obtained. If the velocity profile is distinctly nonstandard, or crosses zero (bidirectional) then a power-curve fit should not be used (use CONSTANT for top and bottom velocity estimates). This technique will be discussed in more detail in chapter 8.

Processing Section

The processing section of the configuration file (fig. 5.14) contains directives to the Transect software that control ensemble averaging, profiled depth, and internal depth-sounder data, as well as directives that control the output of an external velocity monitor (refout):

- Average every () directive can be set to a time value or a spatial value. For example, if the value is set to “average every [5.00 seconds (s)],” then the Transect software will display an averaged output to the console every 5 s. This parameter also can be set to a metric distance value. “Average every (5.00 m)” will send an averaged output to the console every 5 m (16 ft). During data acquisition (acquire) it usually is best to set this value to zero for faster updates to the computer screen. The setting of this value will not affect the raw-data file.
- Depth-sounder value must be set [(YES) or (NO).] If the ADCP has an internal fifth-beam depth sounder, this value should be set to YES; otherwise, it should be set to NO. (This normally should be set to NO, unless you have a special system.)
- BTM layer percent () is a value that overrides the normal maximum bottom profile range percentage (85 percent with 30° transducer angle and 94 percent with 20° transducer angles). This directive need not be used unless the operator wishes to change the default profiling range for the ADCP. This change must be made for old firmware versions for mode 5 operation and for other special circumstances. The accuracy of the Transect software output data can be seriously degraded if this value is set incorrectly. Inclusion of this command is not recommended unless you are trying to use water mode 5 with an older BB-ADCP with phase 2 firmware.

The remainder of the values in the processing section are not discussed in this report, and are used only if data are being sent to an external reference via an RS-232 port. Information on these settings is in the BB-ADCP or Rio Grande technical manual (R.D. Instruments, Inc., 1995–1999).

Graphics Section

The graphics section of the configuration file controls the Transect software display scaling factors. This section is best changed from within the Transect software in either the Acquire or playback software

using the F6 special function key. These settings are discussed in chapters 6 and 8.

History Section

The history section of the configuration file is modified by the Transect software. This section gives the version number of the Transect software used with the configuration file and should not be changed by the operator.

Finishing the Preliminary Configuration File: Required Commands

Before the preliminary configuration file that we created in the first part of this chapter can be used for data collection, some additional commands must be added, either by using an editor or by using the expert mode in the Transect software calibration menu. The sections must be checked, changed, or modified (figs. 5.15–5.18).

Entries in the ADCP hardware section that are added by the Transect software during the first run of the Acquire module are shown in figure 5.15. These entries also can be added using a text editor such as Microsoft Disk Operating System (MS DOS) Edit. The Transect software will check the values against values returned from the ADCP and will deliver a warning to the operator if they do not match.

Entries in the direct command sections that must be checked and entered manually, if necessary, also are shown in figure 5.15. The command syntax and purpose are discussed in the Direct Commands Section earlier in this chapter. The critical entries to check are as follows:

- WPnnn is the water pings per ensemble. This value normally should be set to 1 (example WP001).
- BPnnn is bottom pings per ensemble. This value normally should be set to the same value as the WP value (example BP001).
- ESnn is estimated salinity, in parts per thousand. This value should be set to zero, unless the operator is sure of the actual salinity value (example ES0). The Transect software can calculate speed-of-sound using salinity values after-the-fact.
- EXnnnnn is for coordinate transformation. If beam coordinates are selected, then EX00111 should be used.
- BXnnnn is bottom-track maximum search depth, in decimeters. This value should be set slightly deeper than the expected maximum depth at the measurement site. Loss of bottom track can result if this value is too shallow, and

PROCESSING — Beginning of the ADCP processing parameter section.

```
{
Average every (0.00 s) — Normally set to 0.00 unless you are data averaging
Use Depth Sounder (NO) — Set to NO unless the ADCP has a depth-sounder beam.
MaxFileSize (1200)
External_formats (N N N N N) [HDT HDG RDID RDIE]
External_decode (N N N N) [heading pitch roll temp]
Start_Shore_distance (-1) [cm]
End_Shore_distance (-1) [cm]
Edge_distance_prompt (NO)
Use GPS For Btm (0)
}
```

These data should be left alone unless the ADCP output is being sent to an external monitor or device other than the computer running the Transect software.

GRAPHICS — Graphics parameter section.

```
Units (English)
Velocity Reference (BOTTOM)
East_Velocity (-1.0 1.0 ft/s)
North_Velocity (-1.0 1.0 ft/s)
Vert_Velocity (-0.5 0.5 ft/s)
Error_Velocity (-0.5 0.5 ft/s)
Depth (1 35 bin)
Intensity (50 200 counts)
Discharge (-1 1 ft3/s)
East_Track (-211 211 ft)
North_Track (-190 231 ft)
Ship track (1 bin 0.5 ft/s)
Proj_Velocity (-1.0 1.0 ft/s)
Proj_Angle (250.0 deg from N)
Bad_Below_Bottom (YES)
Line1 ('Standard' Config file for 1200 kHz)
Line2 (Mode 1 -- 25cm bins -- 5 WP 4 BP -- Ship)
}
```

These values are set in the Transect program and should not be changed directly by editing the configuration file.

Information stored in these lines is displayed on Transect's output data plots.

HISTORY

```
{
SOFTWARE (BB-TRANSECT)
Version (4.05)
}
```

This section should not be modified. Transect stores the version number here that was used to collect discharge data.

END RDI CONFIGURATION FILE — This is a required end-of-file statement.

Figure 5.14. Processing, graphics, and history sections of the configuration file. ADCP, acoustic Doppler current profiler; GPS, Global Positioning System; RDI, R.D. Instruments, Inc.

```

BEGIN RDI CONFIGURATION FILE
COMMUNICATIONS
{
  ADCP (ON COM1 9600 N 8 1) [Port Baud Parity Databits Stopbits]
  ENSOUT(OFF COM2 9600 N 8 1) [Port Baud Parity Databits Stopbits]
  NAV (OFF COM3 9600 N 8 1) [Port Baud Parity Databits Stopbits]
  REFOUT(OFF COM4 9600 N 8 1) [Port Baud Parity Databits Stopbits]
  EXTERNAL (OFF COM5 9600 N 8 1) [Port Baud Parity Databits Stopbits]
  UseSoftwareBreak (NO)
}

ENSEMBLE OUT
{
  ENS CHOICE (NNNNNNNN)[Vel Corr Int %Gd Status Leader BTrack Nav]
  ENS OPTIONS (Bottom 1 8 18) [Ref First Last Start End]
  ENS TYPE (RAW) [RAW (default) or AVERAGED data transmitted]
}

ADCP HARDWARE
{
  Firmware (5.57)
  Angle (20)
  Frequency (1200)
  System (SHIP)
  Mode (1)
  Orientation (DOWN)
  Pattern (CONVEX)
}

DIRECT COMMANDS
{
  BX200 — The maximum bottom-track depth is 200 decimeters (20 meters).
  WS50 — Water bin size is 50 centimeters.
  WN060 — Set for 60 depth bins.
  WF50 — Blanking distance is 50 centimeters.
  WV170 — Mode 1 ambiguity velocity is set for 170 centimeters per second.
  WD111100000 — Data collected are velocity, correlation, intensity, and percent good.
  WM1 — Water-measurement mode 1.
  WP1 — One water ping averaged per ensemble.
  BP1 — One bottom ping averaged per ensemble.
  BM5 — Bottom-measurement mode 5.
  EX10111 — Coordinates are ship, with pitch and roll correction and bin mapping enabled.
  ES0 — Salinity is set to zero.
  &R20 — Bottom-track bin size is set to 20 percent of the measured depth.
}

```

This section now has information that should correspond to the current ADCP hardware on your system.

Figure 5.15. Hardware and direct command sections of the configuration file. RDI, R.D. Instruments, Inc.; ADCP, acoustic Doppler current profiler.

```

RECORDING
{
Deployment (FRE5) — Make sure to update this deployment name when
                    using the CFG file in another area.

Drive 1 (C)
Drive 2 (C)
ADCP (YES)
Average (NO)
Navigation (NO)
StartRecording (NO)
}

```

Figure 5.16. Recording section of the configuration file. ADCP, acoustic Doppler current profiler; CFG, configuration (file).

excessive ensemble times can result if it is too deep. For example, a BX0250 command sets the bottom-track maximum search depth at 25 m.

- WMnn, BMnn, and WVnnnn are water and bottom mode commands. These commands should be added per instructions in chapter 3.

The recording and calibration sections of the completed configuration file are shown in figures 5.16 and 5.17, respectively. If the configuration file is renamed for use at another measurement site, the four-character deployment name must be changed to one matching the new site. If the configuration file is reused at another site, the proper transducer draft must be entered. Failure to do so can cause significant errors when measuring shallow/wide rivers. The two-line comment in the graphics section (fig. 5.18) also should be updated when reusing the configuration file.

Transect Release Enhancements (2.80 and Later)

For purposes of brevity, Transect software releases 2.80 and later hereafter will be referred to as Transect 2.80+. The following enhancements are included in Transect software release 2.80+:

- A copy of the configuration file is saved with each discharge data file with the letter C imbedded in the file name. Example—If the raw data file name is JUNK001R.000, then the configuration file is JUNK001C.000.
- The user is prompted for starting and ending edge distances. These values are stored in the configuration file and in the processed data file, if one has been generated.

- The unique configuration file can be loaded automatically and used during the Transect software playback.
- The Transect module “Acquire” starts with recording turned off. This feature eliminates two keystrokes at the start of each measurement. Percent good is redefined by the user in processed data files.
- The Transect software will extrapolate discharge in missing bins.
- Default data file size is changed from 300 kilobytes (K) to 1,200 K.
- Other enhancements are included as detailed in the Transect version 2.80 software documentation.

Transect 2.80+ operation requires some additional commands within the configuration file and at the DOS prompt (or in the Autoexec.bat file).

Earlier versions of the Transect software allowed only for a triangular-shaped edge slope. Transect 2.80+ allows the operator to select an edge slope that can vary from square to no slope at all (fig. 5.19). Entering a -1 directs the Transect software to use a triangular-shaped edge slope (default). Entering a -2 directs the Transect software to use a square-edged slope, and entering a value between 1 and 0 directs the software to use that value as a slope coefficient where 0.91 is nearly square, 0.35 is almost triangular, and 0.05 is nearly flat (fig. 5.19).

In the processing section of the configuration file, there are three new items used by Transect 2.80+. If Edge_distance_prompt is set to YES, then the software will prompt the operator for edge-distance estimates during data acquisition (acquire). The values that are

entered by the operator are saved in the configuration file in the Start_Shore_distance and the End_Shore_distance variables (fig. 5.20).

Several DOS environmental variables also must be set before running Transect 2.80+. DOS environmental variables can be compared to memory “mail boxes.” The system operator puts a directive into a mail box, and when the Transect starts, it checks the mail box, reads the mail, and takes appropriate action. In the case of Transect 2.80+, four environmental variables (mail boxes) are used to send directives to the Transect software. The first environmental variable is typed at the DOS prompt, or in the Autoexec.bat file; (set AUTOSAVECFG = Y). This environmental variable tells the Transect software to save a

configuration file with each save of a raw- (or processed-) data file. The file names have the following form. If the deployment name in the RECORDING section of the configuration file is, ARKN, for example, then the files saved are

- ARKN001R.000 for the raw-data file;
- ARKN001P.000 for the processed-data file (if requested);
- ARKN001C.000 for the configuration file (this is the new one!);
- ARKN001N.000 for the navigation file (if requested).

```
CALIBRATION
{
ADCP depth (0.16 m) — This value must be updated when copying the
DBTDraft (0.00 m)           CFG file for use in a new deployment.
Heading / Magnetic offset (0.00  0.00 deg)
Transducer misalignment (0.00 deg)
Intensity scale (0.43 dB/cts)
Absorption (0.278 dB/m)
Salinity (0.0 ppt)
Speed of sound correction (YES)
Pitch & roll compensation (YES)
Tilt Misalignment (0.00 deg)
Pitch_Offset (0.000 deg)
Roll_Offset (0.000 deg)
Top discharge estimate (POWER)
Bottom discharge estimate (POWER)
Power curve exponent (0.1667)
Edge_slope coefficient (-1.00000) [-1=Trianglar(0.3535):-2=Square(0.91):User]
OneCycleK (0.0000000)
OneCycleOffset (0.0000000)
TwoCycleK (0.0000000)
TwoCycleOffset (0.0000000)
DBTOffset (0.00 m)
DBTScaleFactor (NO)
GPSLead (0.00 s)
}
```

Figure 5.17. Calibration section of the configuration file. ADCP, acoustic Doppler current profiler; GPS, Global Positioning System.

(Graphics section in part)

```
Proj_Angle (250.0 deg from N)
Bad_Below_Bottom (YES)
Line 1 (Sacramento River at Freeport)
Line 2 (Mode 1 -- 25cm bins -- 5 WP 4 BP -- Ship)
}
HISTORY
{
SOFTWARE (BB-TRANSECT)
Version (4.05)
}
END RDI CONFIGURATION FILE
```

} Remember to update this two-line message when redeploying the ADCP in a new area

Figure 5.18. Graphics and history sections of the configuration file. ADCP, acoustic Doppler current profiler; RDI, R.D. Instruments, Inc.

If AUTOSAVECFG = N or is missing, the Transect software will not save a configuration file when it saves a data file.

The second environmental variable is AUTOLOADCFG. Transect 2.80+ will autoload the matching configuration file when a data file is loaded for playback if the environmental variable AUTOLOADCFG is set to Y; (set AUTOLOADCFG = Y). These first two directives greatly enhance the post-processing of the Transect software data files. Although still necessary, the operator is not dependent only upon the log sheets for the recording of edge distance estimates. The operator also will be assured that changes to the transducer draft and other configuration directives will not be inadvertently applied to the wrong data files during playback.

The third environmental variable is STARTRECORDOFF, which can effectively eliminate one minor annoyance that is present in earlier versions of the Transect software; (set STARTRECORDOFF = Y).

This variable tells the Transect software to start the Acquire software with the data recording toggled OFF. Many operators prefer to start the cross-section traverse with the recording turned off because discharge should not be collected with zero good bins or only one good discharge bin. Recording can begin when the operator observes that velocities are being properly measured (chap. 7). Older versions of the

Transect software started with recording turned on and the operator was required to toggle recording off before starting ADCP data collection.

The fourth and final environmental variable relates to the collection of processed-data files. Older versions of the Transect software used an unusual definition of percent good to describe the data in each averaged bin (number of good four-beam and three-beam Earth transformations). In Transect 2.80, the operator can define the meaning of percent good in a processed-data file by setting the following environmental variables; (set USEPERCVEL = Y).

If this variable is set to Y, percent good will equal the number of good velocity values in each bin, averaged together by the Transect software; (set USEPERCQ=Y).

If this variable is set to Y, percent good will equal the number of good discharges in each bin averaged together by the Transect software. Note: the “redefined” percent good will be saved to the processed-data files, but nothing is saved to indicate which of the above two definitions were used.

To ensure that the above environmental variables are set each time the Transect software is run, the operator should edit them into the Autoexec.bat file in the boot drive root directory.

The additions to the Transect configuration file, discussed above, can be entered with a text editor or added from the Transect software calibration menu. In the Transect software calibration menu, the

```

CALIBRATION
{
ADCP depth (0.16 m)
DBTDraft (0.00 m)
Heading / Magnetic offset (0.00 0.00 deg)
Transducer misalignment (0.00 deg)
Intensity scale (0.43 dB/cts)
Absorption (0.278 dB/m)
Salinity (0.0 ppt)
Speed of sound correction (YES)
Pitch & roll compensation (YES)
Tilt Misalignment (0.00 deg)
Pitch_Offset (0.000 deg)
Roll_Offset (0.000 deg)
Top discharge estimate (POWER)
Bottom discharge estimate (POWER)
Power curve exponent (0.1667)
Edge_slope coefficient (-1.00000) [-1=Trianglar(0.3535): 2 =
    Square(0.91):User]
}

```

- Enter "-1" for a Trianglar edge slope (0.3535) (default)
- Enter "-2" for a Square edge slope (0.91)
- Enter a coefficient between 0 and 1 (see diagram)

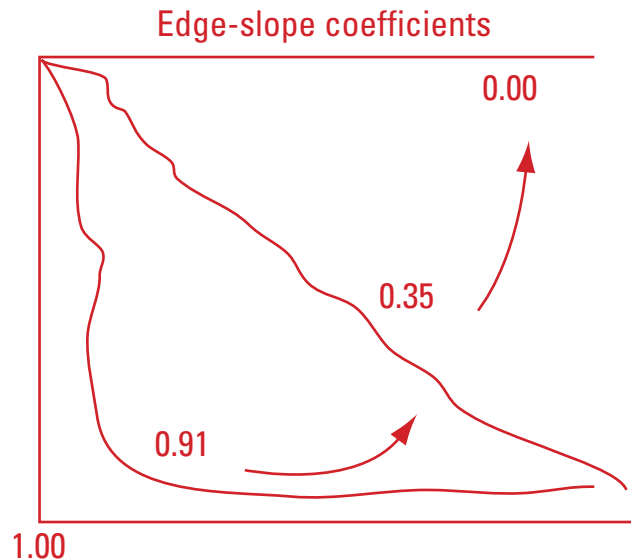

Figure 5.19. Edge-slope coefficient in the Transect 2.80+ configuration file. ADCP, acoustic Doppler current profiler.

```

PROCESSING
{
Average every (0.00 s)
Use Depth Sounder (NO)
MaxFileSize (1200) — This value defaults to 1200 kilobytes. When the file size reaches
1200 kilobytes, it is saved and the file extension is incremented
by 001 and a new file is started.

External_formats (N N N N N) [ HDT HDG RDID RDIE ]
External_decode (N N N N) [ heading pitch roll temp ]
Start_Shore_distance (-1) [ cm ] } These values will be added by the operator during
End_Shore_distance (-1) [ cm ] } transect if ...
Edge_distance_prompt (YES) — ... THIS value is set to YES (prompts the operator for edge
values).
}

```

Figure 5.20. Transect 2.80+ directives in the processing section of the configuration file.

configuration file must be loaded before the operator moves to the scaling screen. In the DISCHARGE EXTRAPOLATION box, the “Prompt for Edge Shore Distances” should be set to YES with the spacebar. The “Edge Shore Coefficient” for the channel should be selected. If the “Edge Shore Coefficient” is unknown, TRANGLE should be selected.

Summary

The Transect software requires a companion configuration file for each measurement session. The

configuration file contains instrument and recording setup data that enable the Transect software to properly measure the cross-section discharge and to store the resulting data. This configuration file can be created from within the Transect software or can be modified from a preexisting configuration file using a text editor. The configuration file should be checked before use with an American standard code for information interchange (ASCII) text editor to verify that the correct direct commands and recording parameters have been included and that unwanted commands are not present.

CHAPTER 6: DATA ACQUISITION

Operation of Transect Software

As described in chapter 5, Transect is a series of stand-alone software modules that are run from an executable menu program named Transect.exe. Transect.exe is an MS DOS-based computer program that can be run from an MS DOS prompt or from a batch file. There are several command line switches that can be used when running Transect, but we will discuss only the “/m” switch. The /m switch runs the Transect software in monochrome mode. It can be used when running Transect on a laptop with a monochrome liquid crystal display or on a laptop with a color screen if increased contrast is desired. For example, if the operator wishes to start Transect in monochrome mode, he would simply invoke Transect by typing TRANSECT /M at the command prompt. The default (color) mode is invoked by simply typing TRANSECT at the command prompt. Unlike unix, MS DOS commands can be typed in upper or lower case.

In chapter 5 we discussed the communication, calibration, and planning modules of the Transect software. In this chapter we will discuss the operation of the Acquire module.

Loading the Configuration File

During Transect initialization, the Transect software must obtain a valid configuration file. The proper configuration file can be loaded manually into the Transect software from any of the menus by pressing F3 and supplying a configuration file name (for example, by typing SACU.CFG). The Transect software stores the name of the last configuration file used in a small file called TRANSECT.PTR. TRANSECT.PTR may be edited and modified prior to entering the Transect software. For example, the TRANSECT.PTR file contains the following command: C:\SACU.CFG. When the Transect software starts, it will look for a file named SACU.CFG for its initial configuration. Any valid file path name can be entered into TRANSECT.PTR. For example, when TRANSECT.PTR is edited and C:\SACU.CFG is replaced with C:\BBTRAN26\SACU.CFG, the Transect program will find and load SACU.CFG from the C:\BBTRAN26 directory.

Starting the Transect Acquire Module

Entry into the Acquire menu (fig. 6.1) causes the Transect software to load a configuration file using the path name in the TRANSECT.PTR file. If a valid file name is not present in TRANSECT.PTR or if

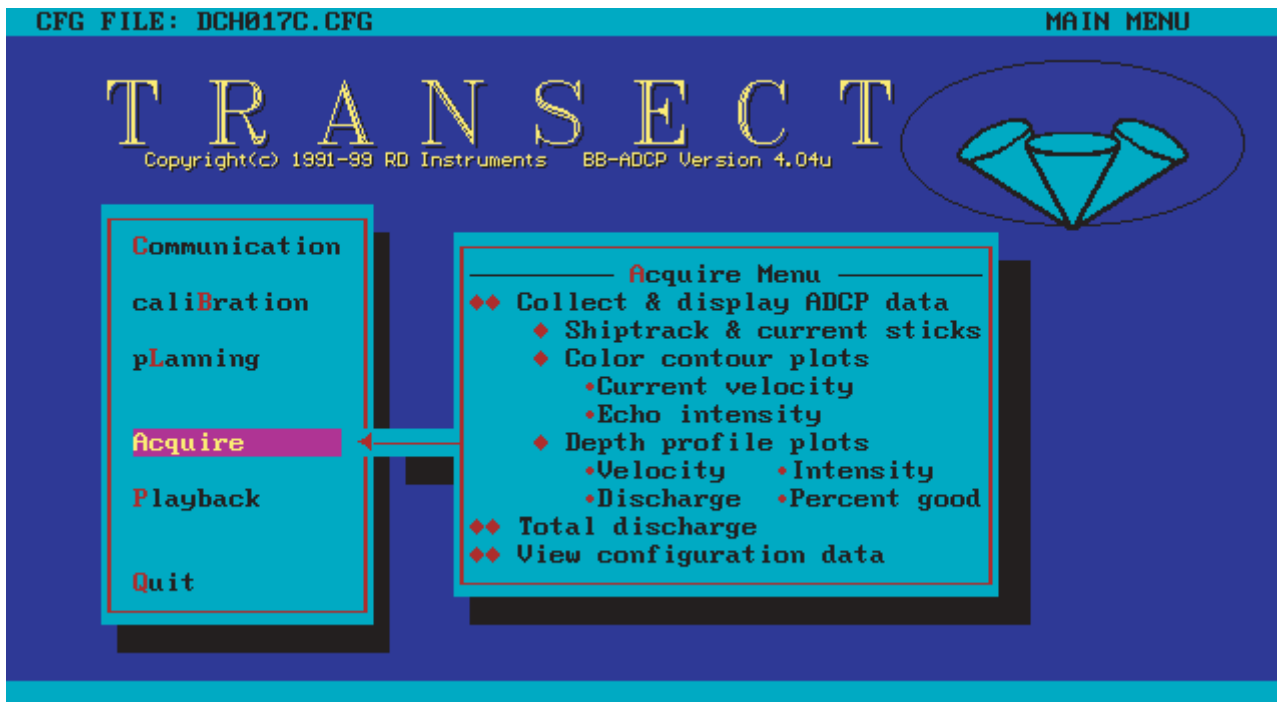

Figure 6.1. Transect software main menu. BB-ADCP, broad-band acoustic Doppler current profiler.

TRANSECT.PTR is not present, Transect will prompt the operator for a configuration file name. After loading the configuration file, Transect sends a “break” signal to the ADCP and waits a short time for a response. This is termed “waking up” the ADCP. If the ADCP does not wake up, usually it is because the operator has failed to turn on the power from the deck unit or that a communications or power cable has not been connected. If all attempts to communicate with the BB-ADCP from the Acquire menu meet with failure, the operator can do one of two things: exit the Transect software and try to establish communication with the ADCP using BBTALK or another terminal-emulator program, or enter the Transect software communication ADCP submenu and select auto connect. The Transect software will cycle through all combinations of baud rates and configuration combinations until it successfully establishes communications or it makes so many failed passes that the operator finally loses patience and calls for help. The BB-ADCP technical manual contains trouble-shooting procedures in cases of BB-ADCP failure or apparent faulty operation.

Once the ADCP is communicating properly, the introductory screen for the Acquire menu will appear on the monitor. This screen (fig. 6.2) contains helpful information on the setup and configuration of the ADCP:

- ADCP communication parameters;
- ADCP firmware parameters—firmware-release version, beam angle, operating frequency, coordinate system, operating mode, orientation system, and head configuration (pattern);
- Recording selections;
- ADCP operating variables: depth cell length, number of depth cells, pings per ensemble, time between pings, and blanking distance;
- Configuration file processing parameters.

The BB-ADCP operator should inspect the data for accuracy before continuing with the Transect software session.

Transect-Data Displays

The F10 or escape key then can be pressed to invoke the Transect software profile menu.

The Acquire menu provides many different ways to view ADCP data as they are being collected. Typically, most users will view incoming data using the Tabular display. Some of the available data displays are described below:

- Profiles of water velocity, echo intensity, and discharge cross product may be displayed (fig. 6.3).

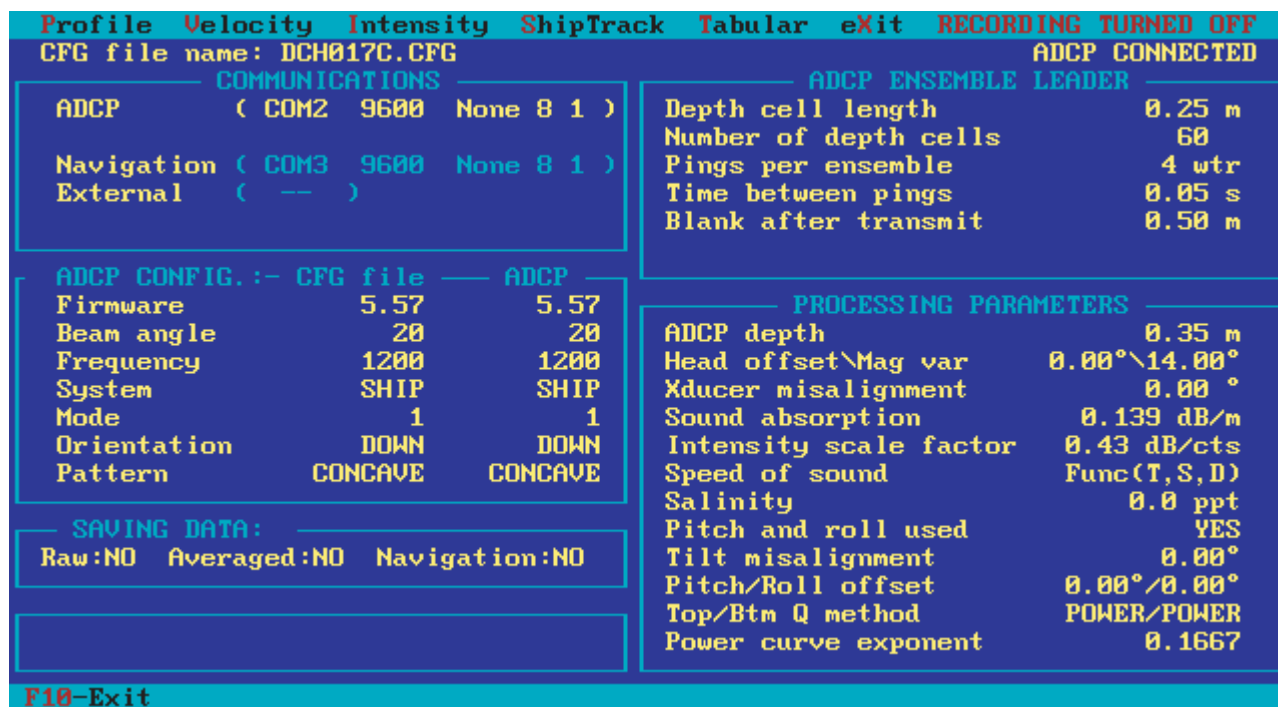

Figure 6.2. Transect software Acquire introductory screen. ADCP, acoustic Doppler current profiler.

- Color or monochrome plots of north velocity, east velocity, vertical velocity, error velocity, and velocity along a user set azimuth may be displayed (fig. 6.4).

- Backscattered intensities (fig. 6.5) also may be contour plotted. This can be useful for providing the operator with a relative indication of

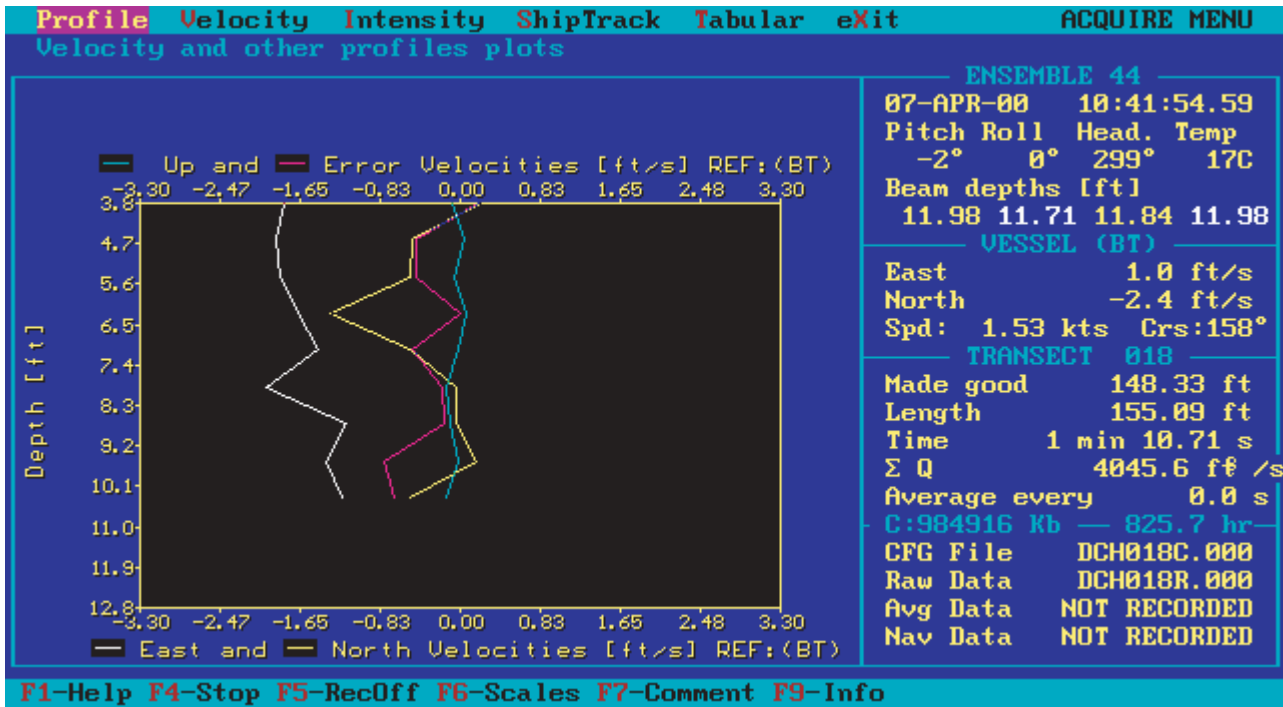

Figure 6.3. Transect software Acquire profile menu screen.

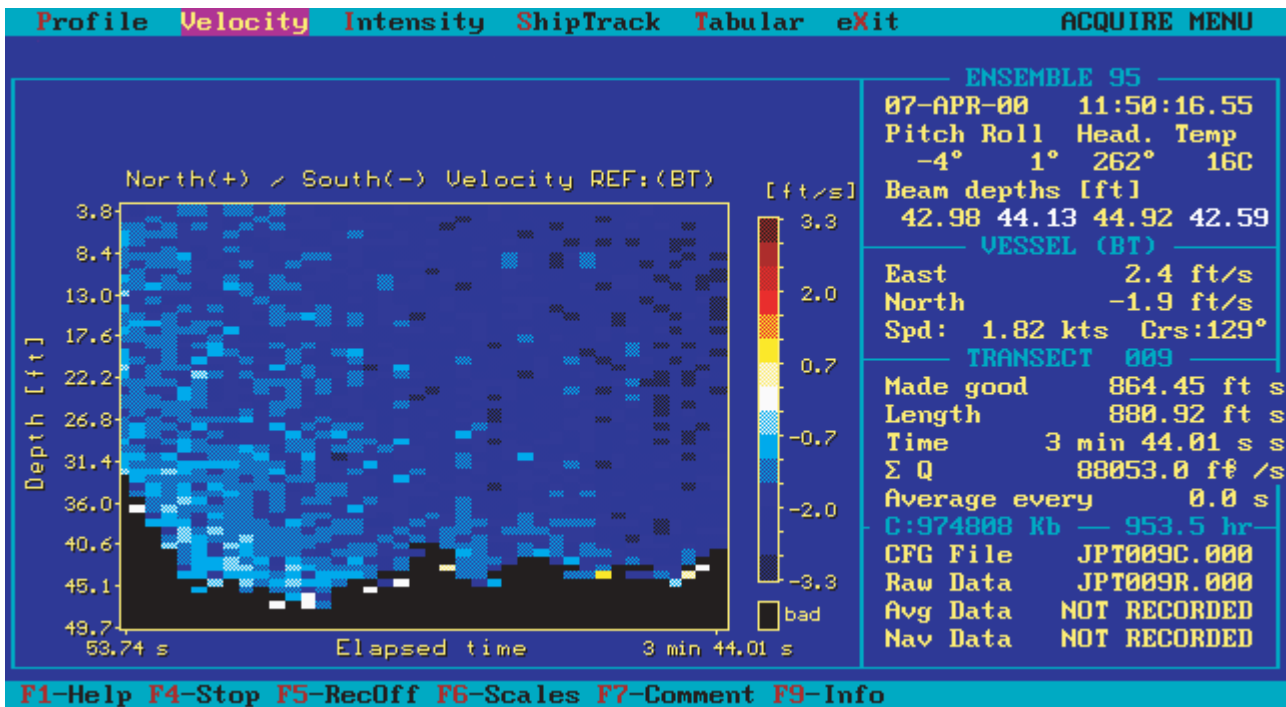

Figure 6.4. Transect software Acquire velocity contour plot screen.

suspended-sediment concentration in the measured cross section.

- The movement of the boat can be displayed in the so-called shiptrack plot (fig. 6.6). The

operator also can display velocity vector “stick” plots at specified depths.

- Measured velocities, intensities, and correlations may be displayed in tabular form

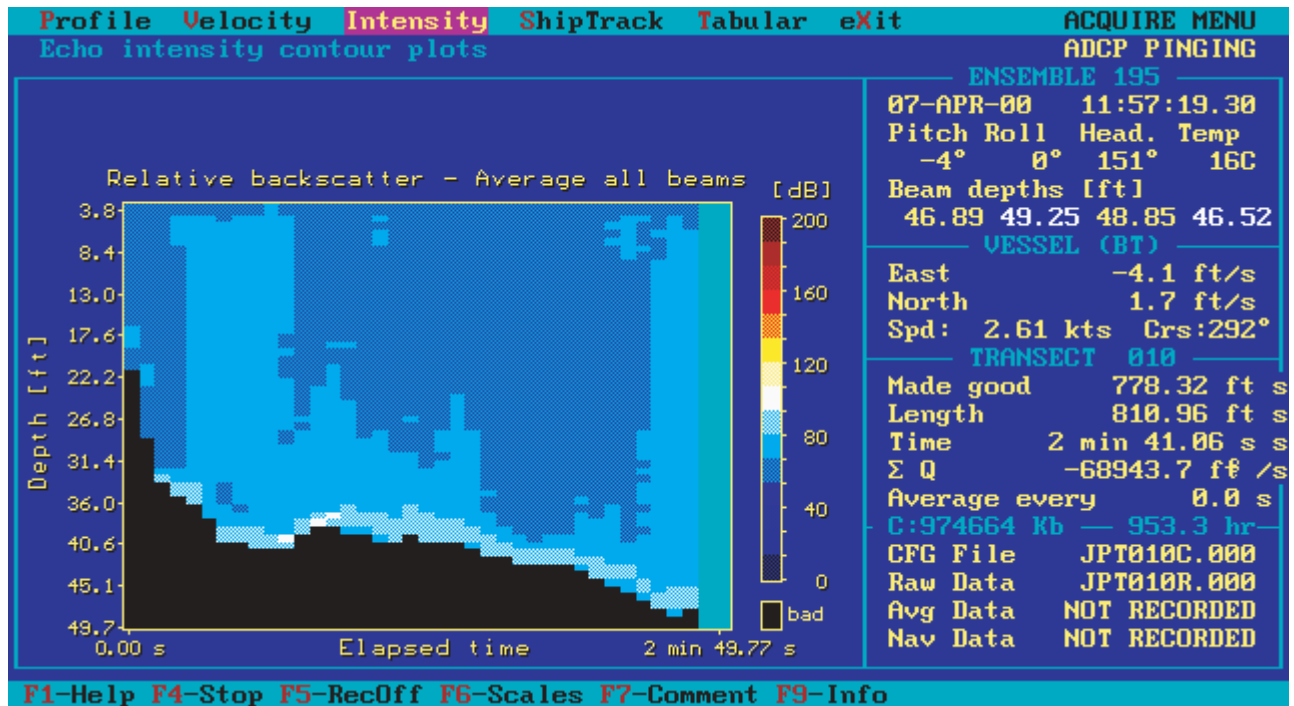

Figure 6.5. Transect software Acquire intensity contour plot. ADCP, acoustic Doppler current profiler.

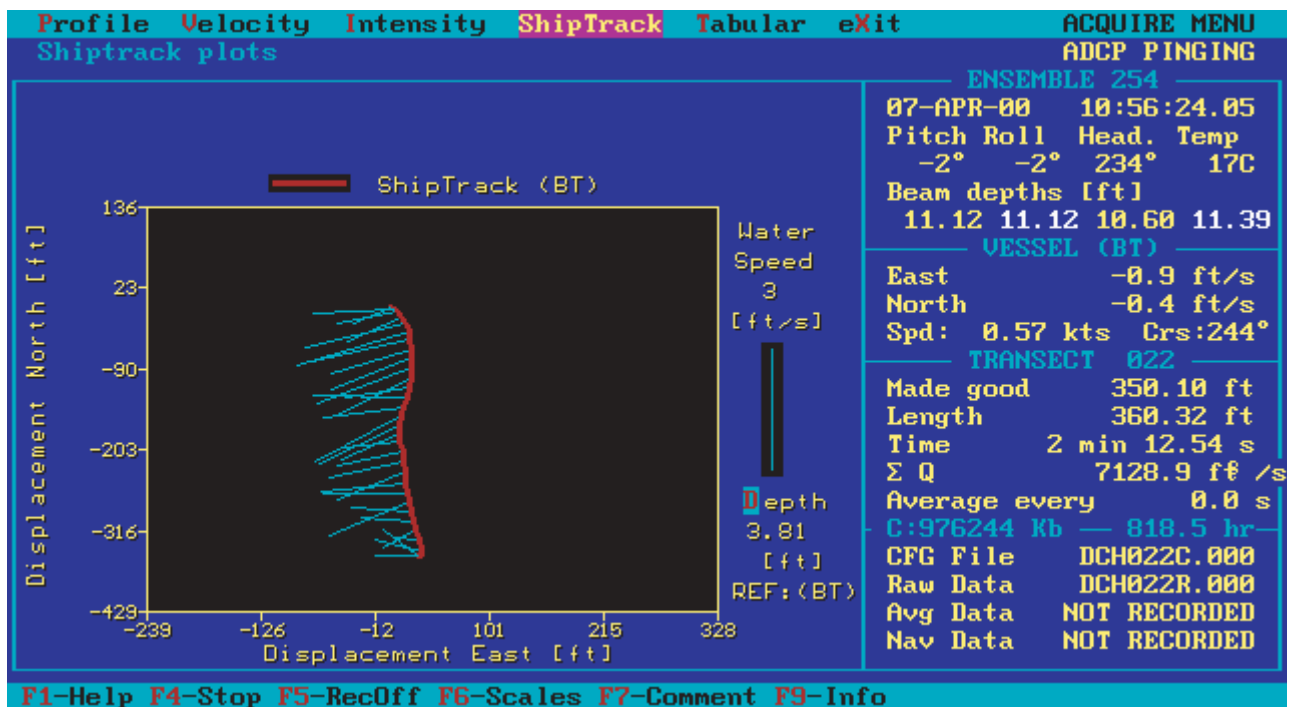

Figure 6.6. Transect software Acquire shiptrack plot. ADCP, acoustic Doppler current profiler.

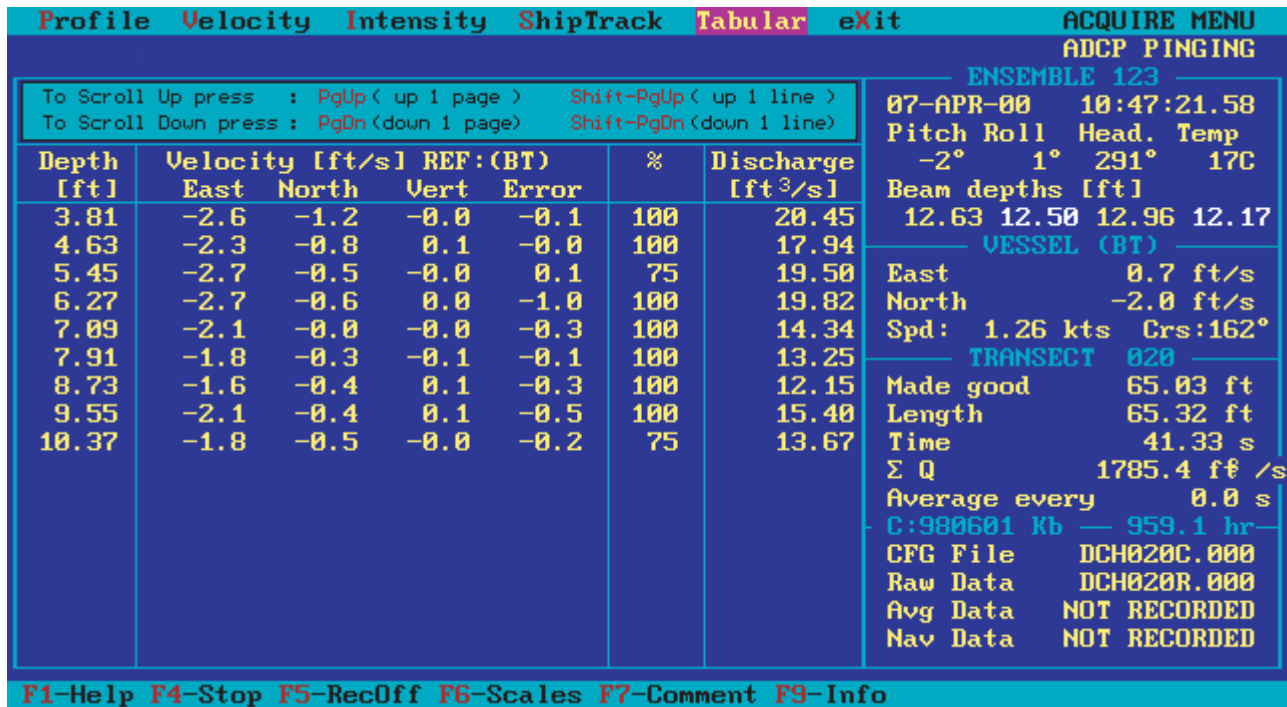

Figure 6.7. Transect software Acquire tabular display screen. ADCP, acoustic Doppler current profiler.

(fig. 6.7). The tabular screen is the most useful of the many displays available because of the information it imparts. The operator can tell quickly if error velocities are high, or if beam measurements or bottom tracking are bad, and scale factors need not be preset.

Transect-Data Recording

Data are recorded under the file name given in the RECORDING section (figs. 5.11 or 5.16) of the configuration file. Recording of the data to a data file is controlled by toggling the F5 key. When the Transect software is instructed to start recording (by toggling the F5 key), the discharge-measurement registers (but not the ensemble counter) are set to zero. The F4 key, on the other hand, wakes up the ADCP, starts the ADCP pinging, and resets the discharge-measurement registers and ensemble counter. Chapter 7 presents a detailed description of the use of the F4 and F5 keys.

Summary

Transect software data acquisition is invoked using the Acquire menu. The Transect software always loads the last used configuration file. There are two ways to load a new configuration file. The first is to edit the TRANSECT.PTR file and insert the path name of the configuration file before starting the Transect software. The second is to use the F3 key when starting the Transect software. The software then will prompt the operator for a configuration file name.

Actuating the F4 function key starts the data collection by the acoustic Doppler current profiler (ADCP). Recording can be toggled on and off with the F5 key.

Data displays during data acquisition can be selected by the operator. The tabular view is one of the more useful displays available during data collection. Some operators prefer to collect data while displaying profile plots of velocity magnitude and direction.

This page left blank intentionally.



Figure 7.1. Improper discharge-measurement technique.

CHAPTER 7: DISCHARGE-MEASUREMENT PROCEDURE

In this chapter we will discuss procedures for making discharge measurements (fig. 1) utilizing the ADCP and the Transect software. The following topics will be discussed in detail:

- Cross-section reconnaissance
- Premeasurement checkout
- Boat-maneuvering techniques
- Transect software tips and tricks during the discharge measurement
- Alternate discharge-measurement techniques for low-flow conditions
- What constitutes a “good” discharge measurement
- Recent Transect software enhancements

Cross-Section Reconnaissance

Figure 7.2 shows a 91-m- (300-ft-) wide stream with tidally affected flows having a roughly trapezoidal cross section with average depths of 4.5–6 m (15–20 ft). This cross section on Dutch Slough near Oakley, California, is typical of rivers in the northern California Sacramento/San Joaquin River Delta. Proper cross-section reconnaissance is vital to the precision and accuracy of ADCP discharge measurements. The measurement vessel depth sounder or the ADCP depth-range measurements are useful tools in determining the usability of the cross section for ADCP discharge measurements.



Figure 7.2. Discharge-measurement cross section on Dutch Slough near Oakley, California.

In general, the ADCP operator should look for a cross section with a roughly parabolic, trapezoidal, or rectangular shape, having an average depth of at least 1.5 m (5 ft). The measurement sometimes can be made at locations having less depth, if water modes 5 or 8 are employed (chap. 3).

Cross sections with asymmetrical bottom topographies should be avoided, if possible. For example, the operator should avoid a measurement cross section that is very shallow on one side and deep on the other.

Average water velocity also is an important factor in choosing a measurement cross section. Cross sections exhibiting slow [less than 10 cm/s (0.30 ft/s)] average velocities should be avoided. Although measurements can be made under these conditions, special techniques must be employed (discussed later in this chapter).

Premeasurement Checkout

After the boat is launched and the ADCP equipment is set up, care should be taken to obtain an accurate transducer depth measurement.

If a side-swing mount is used, the weight of the operator(s) can cause an unwanted pitch of the ADCP vessel (fig. 7.3). This pitch angle may cause an erroneous reading of the ADCP depth. For example, when the operator moves to the side of the vessel to measure transducer depth, the vessel pitches to that side because of the operator’s shifted weight. The operator notes the depth of the ADCP below water surface, and then returns to his normal position in the vessel causing the vessels pitch to return to the original value. This



Figure 7.3. Broad-band acoustic Doppler current profiler mount being deployed vertically.



Figure 7.4. Discharge-measurement log sheet/note.

recorded depth measurement will be incorrect. Because the transducer depth measurement is used in the Transect software to compute discharge, the error in ADCP depth sometimes can cause a significant bias of the ADCP discharge measurement. This is true especially for wide, shallow rivers.

Before the discharge measurement begins, the operator should note any conditions relevant to the discharge measurement on the discharge-measurement log sheet (fig. 7.4). Wind, bidirectional flow, eddies, standing waves, passing boats, and sediment conditions are just some of the things that should be noted for later analysis of the discharge measurements.

Before a discharge measurement begins, the operator should complete the following tasks:

- Meet all DOI boat-safety requirements and make sure all required life jackets, throwable devices, fire extinguishers, and horns are in good working condition aboard the ADCP vessel.
- Determine the “unpitched” transducer depth and enter it on the log sheet and in the configuration file.
- Perform a PT200 diagnostic test using BB-TALK or other terminal emulator software. Save the test results to an ASCII file placed in the deployment directory.
- Synchronize the computer, ADCP, and operator watch times.
- Perform a short reconnaissance of the cross section to determine shallow areas and the shape of the cross section so that unmeasured areas near the bank can be characterized. If the cross section is unsuitable for any reason (too shallow

in places, for example), select another measurement cross section.

- If buoys are used to aid the estimation of edge distances, they should be deployed and the distance to shore from each buoy should be measured and noted on the discharge-measurement log sheet.
- If range finders are used to determine edge distances, they should be checked for proper calibration.
- Record weather, hydrological, and other physical phenomena pertinent to the discharge measurement on the discharge-measurement note.
- Make sure that the right configuration file has been loaded properly into the Transect software.
- Make sure that the power supply has been turned on and the ADCP has been “awoken.”

Boat-Maneuvering Techniques

Boat-maneuvering techniques for discharge measurements when using the ADCP and the Transect software do not require the precision once needed for conventional moving-boat discharge measurements. However, there are some basic maneuvers that improve accuracy and allow smooth transitions between measurements.

Starting the Cross-Section Traverse

For a typical measurement, the operator must maneuver the boat close to, and parallel with, the riverbank (fig. 7.5). The boat should be maneuvered in as close as possible to the bank without grounding (bottoming out) the boat motor propeller or the



Figure 7.5. Acoustic Doppler current profiler vessel at the beginning of a discharge measurement.

BB-ADCP transducer assembly. Performing this maneuver takes practice.

While the boat is somewhat stationary, the operator should start the Transect software and set the Acquire display to tabular velocity mode (initial setting). The tabular mode setting is optional as the Transect software will collect data in any display mode. However, the tabular mode enables the operator to determine if there is an adequate number of depth cells (having good discharge) before starting the measurement traverse. This capability provides the greatest advantage over the other display modes, especially when starting and ending the discharge measurement.

At this point, the operator is beginning the discharge measurement and must accomplish several tasks quickly:

- The distance to shore must be estimated by some means and recorded.
- The operator must turn the ADCP data recording off by pressing the F5 key and must start the ADCP pinging by pressing the F4 key.
- While looking at the tabular display, the operator must verify that the ADCP is collecting at least two good bins of velocity data.
- When the operator is satisfied that accurate data are being collected and the boat is in the correct position to start the discharge measurement, he must press the F5 key to begin recording and wait until two good ensembles have been collected. During this period (about 5 s), the boat should be barely moving toward center channel.



Figure 7.6. Acoustic Doppler current profiler vessel near center channel.

During the Cross-Section Traverse (Transect Tips and Tricks)

When the Transect software begins collecting data, the operator should verify that there is an “ADCP PINGING” message near the upper right of the monitor display and that a transect recording file is opened (file name visible at the lower right of the Transect software screen). At this time the boat should have just begun traversing the river cross section. The operator must quickly scan the initial ensemble display to determine if everything is operating correctly. Signs of improper operation are flagged “bad” in all columns and rows or “bad” in all rows of an individual column. The display columns correspond to north velocity, east velocity, vertical velocity, error velocity, and percent good. If the incoming data appear correct, the operator should continue the transect with the same course and a slightly increased speed (approximately that of the water or slightly less). As the boat enters faster flow, engine revolutions per minute (rpm) and boat heading may have to be adjusted slightly to enable a smooth traverse (fig. 7.6).

Uniform boat speed during a transect is more important than steering a straight course. The course may be allowed to change slightly and slowly, if necessary, during the traverse. However, rapid course and boat heading changes can introduce errors into the measurement. The key element here is to **DO EVERYTHING SLOWLY**, including course changes, the speed of the vessel itself, and even the speed of persons moving around onboard the measurement vessel. Sharp accelerations of the measurement vessel in any direction should be minimized or eliminated.

Ending the Cross-Section Traverse

As the vessel approaches the opposite edge of the measuring section, the boat should be slowed by slowly changing the heading to a more upstream direction and slowing the boat motor. The boat then can creep (crab) toward the bank. When the operator decides that the approach cannot be continued further, an edge value is determined, and the F5 key is pressed to end the transect.

At the end of a cross-section traverse (fig. 7.7), the boat heading is changed just enough so that the boat stops its bankward movement and begins to slowly creep in the direction of center channel. At this point, the operator may press the F5 key again to begin another transect and obtain a starting distance value. Slow “crabbing” at the start and finish of each cross section works better than nosing the boat into the bank and then backing away. The ADCP should not be allowed to pass over the boat propeller vortex during the discharge measurement. Entrained air in the vortex will cause failure of the BB-ADCP bottom track and result in lost ensembles.

The operator should practice the above described technique a few times before an actual transect session is begun so that you (and the boat operator) can become accustomed to the flow conditions at this location. The more practice you have in making these measurements, the more uniform will be the measurement results. When maneuvering near the riverbank, you must remember that making a large heading adjustment away from the bank (swinging the bow away from the bank) will bring the stern (and, therefore, the engine prop and shaft) into contact with the bank or bottom. This maneuver can produce highly undesirable results.



Figure 7.7. Acoustic Doppler current profiler vessel at the end of a cross-section traverse.

The boat will crab slowly away from the bank with only minor adjustments needed in the boat steering.

Alternate Techniques Used During Low-Flow Conditions

The above described technique works only when there is sufficient stream velocity to allow the boat to crab. At very low stream velocities [less than 10 cm/s (0.33 ft/s)], the boat must be turned VERY SLOWLY to enable a direct crossing of the stream. In some cases, the best approach is to raise the engine and pull the boat slowly (at the stream velocity or less) across the stream with ropes or a tag-line (fig. 7.8).

The winching system shown in figure 7.8 was used to measure leakage through control structures in the USGS Illinois District (Oberg and Schmidt, 1994). Because the velocities measured were very slow



Figure 7.8. Winching system used to move an acoustic Doppler current profiler vessel at slow speeds.

[around 10 cm/s (0.3 ft/s)], the ADCP was winched slowly across the control structure opening to reduce the random error in the discharge measurement (chap. 9).

To gain reasonably accurate measurements in very slow moving water, special setup commands must be used to increase the measurement pulse lag times (chap. 5). The use of these long lag times causes the ambiguity velocity to be very low. Therefore, the boat must be moved across the stream ever so slowly (as if rows of dominoes were balanced on the gunnels).

What Constitutes a “Good” Discharge Measurement?

The ADCP operator should consult Lipscomb (1995) for guidelines on discharge-measurement requirements and documentation procedures. However, because these instruments are relatively new and sometimes used for special purposes, common sense also will dictate the procedures in some cases. General procedures conforming to the quality-assurance plan are presented here, but the ADCP operator is cautioned to observe conditions and to document as much information as possible during the transect session. With the advent of electronic instruments used for data recording, valuable information can sometimes “fall through the cracks” and may not be missed until the ADCP operator reviews the data back at the office.

Because a BB-ADCP transect may be made much faster than a conventional discharge measurement, multiple transects usually are averaged to increase discharge-measurement accuracy. During fairly uniform conditions, a group of four or more transects usually are averaged for a final discharge-measurement value. If one transect differs significantly (± 5 percent) from the rest, and there is no rationale to discard it, at least four additional transects should be obtained and the average recomputed. The average of these transects can be reported as an individual discharge measurement and logged on a USGS ADCP discharge-measurement note (fig. 7.9). The back of the USGS measurement note has space for 14 transects, their edge-value estimates, and other pertinent data (fig. 7.10).

In figure 7.10, the values labeled standard error (range) and standard error (percent) near the bottom of the note are critical for measurement results in steady-flow conditions. For fairly uniform flow conditions, at least four ADCP discharge measurements should be made to determine mean and standard-deviation values. From these data, the standard error, in percent of mean

discharge, should be calculated. The standard error, in percent of mean discharge, also is known as the coefficient of variation (CV). The CV is calculated by dividing the standard deviation (in discharge units) of the four transect discharges by the mean discharge. If the CV is larger than 5 percent, additional measurements should be made. A large CV can be an indication that the ADCP ping rate is too slow, or that the boat should be slowed during the cross-section traverse to collect more pings. Outliers or single, bad, transects can cause a large CV, however, they should not be simply thrown out without an attempt to discover the reason for their imprecision. When in doubt, it is always advisable to collect additional transects.

For measurements of net flow in tidally affected estuaries and rivers, many discharge measurements may have to be made (more than can be logged on the example ADCP discharge-measurement form). Figure 7.11 shows a series of transects made at a tidally affected gaging station on a tributary of the San Joaquin River.

In these cases, a discharge-measurement log sheet (fig. 7.12) may be used with pertinent data logged on a discharge-measurement note (fig. 7.9) that is attached to the log sheet. This log sheet is used by the USGS California District. Standard-deviation calculations for tidally effected discharge measurements are meaningless unless the “true mean” discharge can be calculated. Because of the difficulty in calculating the coefficient of variation for tidally effected discharge (or any dynamically changing discharge), its inclusion on the discharge-measurement note example (fig. 7.9) is of questionable significance.

Where tides or discharge conditions are changing rapidly, the operator may not wish to average transects and, in these cases, a single transect constitutes a discharge measurement. In most cases, many measurements will be required to have as much coverage as possible of the dynamic flow time series. Single measurements should be logged on a BB-ADCP discharge-measurement note (fig. 7.9) and if many are made, they should be logged on a discharge-measurement log sheet (fig. 7.12) with an attached USGS discharge-measurement note. Again, standard-deviation calculations or coefficient of variation calculations, in these cases, are of questionable value.

Archival of Acoustic Doppler Current Profiler Discharge-Measurement Data

Transect software data files should be placed on archival media in the following form:

U.S. DEPARTMENT OF THE INTERIOR
Geological Survey
WATER RESOURCES DIVISION
ADCP DISCHARGE MEASUREMENT NOTES

Sta. No. 11-4670.50 Meas. No. 186
Comp. by AMS
CK'd by AMS

Sacramento River near Sacramento

Date August 11, 1996 Party Simpson, Adorador, Posey
Index Vel 1.15 G.H. 9.23 Rt Area tidal -- see back of sheet Discn _____ Rt Vel _____
Firmware Ver 5.43 Transect Ver 2.80 Water mode 4 Bottom mode 5
ADCP S/N 296 X-ducer Freq 1200 Boatmotor used Mercury 45
X-ducer depth 0.30m Blank Dist 0.50m Cell depth 0.25m ADCP set to watch yes
No. water pings 5 No. bottom pings 4 ADCP diag. test pt200 passed

GAGE READINGS					EDL DATA	
Time		Inside	Outside		Vel	
1230	s	9.20	9.19		1.11	Downloaded before meas. ✓
		see back for meas				File name <u>f081196</u>
1240		9.22			1.14	DATA OK? <u>Yes-good rcrd</u>
1250		9.24			1.15	EDL set for meas.
1300		9.25			1.17	Time <u>1220</u> interval <u>10m</u>
1310	f	9.26	9.25		1.20	EDL reset
						Time <u>1320</u> interval <u>15m</u>
						EDL set to watch <u>1220</u>
						ADCP DATA
Weighted Mean						Config <u>fre5.cfg</u>
Correction						Nav file <u>n/a</u>
Corrected Mean		9.23			1.15	Vel file <u>fre50xx.000</u>

Check bar: chain found 23.34 changed to _____ at _____
Wading, cable, ice, boat upstr. downstr. side bridge 100 feet mile above below gage
Measurement rated excellent (2%) good (5%) fair (8%) poor (over 8%) based on the following
Flow Uniform except for eddy on right bank
Cross section roughly trapezoidal, shallow on RB side
Control channel / tidal reach -- no visible riffle or water level change
Weather cloudy/light rain Wind spd 2 mph Direction NE
Stratification normal profile

Visual Vel 1.00 upstr downstr

Water Density Conditions			
Time	Temp	Cond	Depth
1200	19c	100 ms	5m
1202	19.2	110 ms	0m

Gage operating No last record Battery voltage 13.5 Manometer Pressure Tank 1900
HWM Tidal seed line @ 10.22 ft outside in well
Remarks Eddy on RB causing a flow reversal from bank out to 20 feet or so.

Figure 7.9. Example of an acoustic Doppler current profiler (ADCP) discharge-measurement note (front).

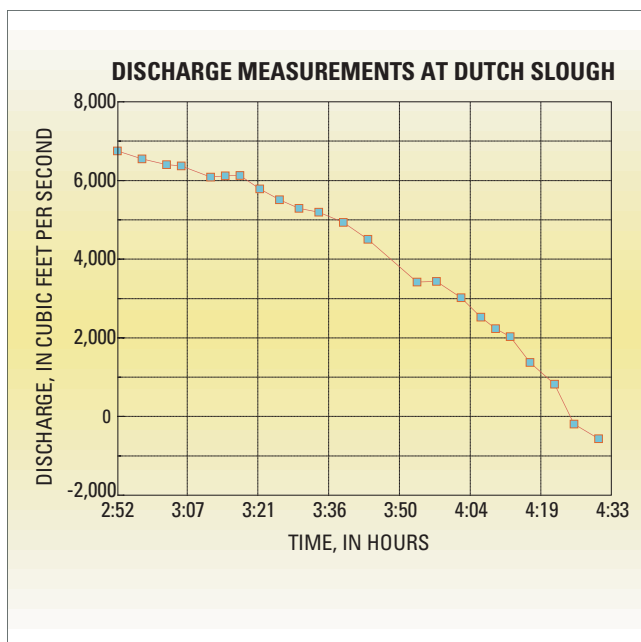

Figure 7.11. Discharge-measurement data from a tidally affected gaging station on a tributary of the San Joaquin River.

media may consist of a compact disk, read-only-memory (CD-ROM), optical media (30-year), or a disk drive on a computer system that is backed up regularly. The computer hard disk of the laptop used for data collection is not considered “safe media.”

Summary

A smooth bank-to-bank transect technique is essential for accurate discharge measurements. The operator always should remember that slow, smooth boat movements are desirable.

For steady-state flows, at least four transects should be made and the results averaged to calculate a

“discharge measurement.” If one measurement is more than 5 percent from the mean, four additional transects should be collected and averaged. A CV should be calculated from the discharge-measurement series by dividing the standard deviation, in units of discharge, by the mean of the series. If the CV is greater than 5 percent, the ping rate should be increased or the boat slowed during the transect to collect more pings per transect. Additional transects should be made until a series of four is obtained having a CV of less than 5 percent.

For discharge measurements made in tidally affected rivers and estuaries, the CV value and standard deviations cannot be computed easily and, therefore, are not used. However, comparison and common sense sometimes can detect inaccurate transect discharges. In these cases, a single transect can be used as a discharge measurement, although many measurements usually are made during a discharge-measurement session to define the dynamic flow conditions.

Suitable log sheets and discharge-measurement notes must accompany the discharge-measurement series. The operator should store a copy of the configuration file that is used for the series in the Transect software deployment directory with a documentation file containing edge values and other pertinent information (described above). A documentation file should be stored with the Transect software data files describing stream conditions and pertinent information not collected by the Transect software.

All Transect data files and accompanying configuration and documentation files should be archived to “safe” media as soon as possible after the measurements are made. Although paper-copy records can be kept for records computation, acoustic Doppler current profiler discharge-measurement archives should be such that the discharge measurements could be wholly recreated from data stored on electronic media.

United States Department of the Interior
Geological Survey
Water Resources Division

ADCP Discharge Measurement Notes

Sta. No.: 11-4670.50 Name: Sacramento River @ Freepart, CA.
 Date: Aug 31, 1996 Party: Simpson, Aborder, Posey
 Width: 530 Area: 1019 Vel. 2.140 G.H. 1.20-1.40 Discharge Tidal

ADCP Information

Ser. No. 296 Firmware 5.43 Software 2.72 Diagnostic Test Pass
 ADCP draft: 0.34 m Depth Cell Size: 0.25 m

Recorder ADCP Watch	Hour	Minute	Second	Circle	Transducer	Beam	Shore Description	
	<u>12</u>	<u>45</u>	<u>05</u>	<u>CST</u>	Frequency	Angle	Left	Right
	<u>12</u>	<u>45</u>	<u>20</u>	CST	<u>1200</u>	<u>20</u>	<u>Sloping</u>	<u>Sloping</u>
	<u>12</u>	<u>46</u>	<u>10</u>	CST			Vertical	Vertical

Transect Number	Watch Time	Distance to Shore Start	Distance to Shore End	Start Back	Sum Q	Edge Estimate	Total Discharge	Config File	Remarks
001	1220	50	40	L R	12433	320		FRE6.CFG	file fre6001R.000
002	1225	42	60	L R	12524	298		"	Passing Boat (wake)
003	1228	38	43	L R	12632	265		"	Wind picking up 5.0 mph
004	1232	49	60	L R	12722	300		"	
005	1235	58	37	L R	12845	305		"	
~~~~~BAD~~~~~				L R					
006	1239	42	50	L R	12963	285		"	Small white caps
007	1243	53	39	L R	13005	242		"	
008	1247	36	62	L R	13107	303		"	Large ship passed (wake)
009	1252	64	37	L R	13152	312		"	
010	1256	56	63	L R	13098	320		"	
011	1301	66	39	L R	13005	301		"	Getting more windy 10 mph
012	1305	42	54	L R	12970	259		"	
013	1310	57	39	L R	12920	288		"	
014	1314	43	62	L R	12860	276		"	nees not too good (wake)
015	1319	60	39	L R	12740	300		"	
016	1323	32	57	L R	12610	296		"	
017	1328	56	37	L R	12500	299		"	really windy ~20 mph
018	1342	39	62	L R	12320	276		"	
019	1346	61	38	L R	12200	300		"	Went to Dutch Slough
				L R					

Figure 7.12. Discharge-measurement log sheet. ADCP, acoustic Doppler current profiler.

This page left blank intentionally.

## CHAPTER 8: DISCHARGE-MEASUREMENT REVIEW AND ASSESSMENT

Individual transects should be checked for discharge-measurement errors and inconsistencies as soon as possible after collecting the discharge-measurement series. In most cases, this examination is done at the office or in a motel suite, but it can be done at the measurement site. The data are examined by using the Transect software to reconstruct the measurement from the stored raw data and configuration files. This is termed “playing back” the discharge measurement. During playback, the edge discharges also can be estimated, and the power-curve (or other) estimation scheme used near the top and bottom of the profile can be examined for correctness and changed, if necessary.

Proper review and assessment of ADCP discharge measurements is almost as important as the techniques and instrument setup used to collect the original data. Improper instrument setup and faulty measurement techniques can be revealed during post processing and, in some cases, corrections can be made to improve discharge-measurement accuracy.

Review of ADCP discharge measurements should include the following steps.

- Configuration file review with focus on the applicability of the following sections to river conditions:

- ADCP hardware setup
- ADCP direct commands
- ADCP calibration constants

- Transect software playback with focus on the following subjects:

- Missing data ensembles
- Possible bottom-sediment movement
- Magnitudes of discharge in the unmeasured (estimated) parts of the cross-section near the top and bottom of the profile
- Technique used for low-velocity [ $< 10$  cm/s (0.33 ft/s)] measurements
- Power-curve-fit applicability
- Reasonableness of edge values
- Shiptrack examination

These assessment procedures are discussed in the following paragraphs.

### Configuration-File Review

The first thing that should be checked is the applicability of the configuration file to the data file and to river conditions. The ADCP discharge-measurement

notes should indicate the location of the configuration file used for the discharge-measurement series or contain a listing of the file.

### River Conditions

The configuration file should be examined in a text editor to determine if the proper setup and configuration commands were used for the stream or river being measured. All sections should be checked, but the most important are the ADCP hardware, the direct command, and the calibration sections:

#### Acoustic Doppler Current Profiler Hardware

- First examine the ADCP Hardware section of the configuration file.

(example)

```
ADCP HARDWARE
{
Firmware           (5.45)
Angle (20)
Frequency (1200)
System (BEAM)
Mode (4)
Orientation (DOWN)
Pattern (CONCAVE)
}
```

Are these entries compatible with the ADCP used to make the discharge measurements? Is the proper mode being used for the river or stream in question?

#### Acoustic Doppler Current Profiler Direct Commands

- Next examine the Direct Commands section of the configuration file.

(example)

```
DIRECT COMMANDS
{
WS25
WF50
BX200
WN060
WD111100000
WP00001
BP001
WM1
BM5
ES0
WE0450
}
```

Is the blanking distance (WF) adequate for the transducer frequency? Is the bin size (WS) proper for the transducer frequency? Are enough depth bins specified (WN) to cover the range of depth measured? A few playback profiles may have to be examined



before this question is answered. Is the bottom track maximum depth (BX) greater than the maximum stream depth? If BX is less than the maximum depth, there will be missing ensembles. Are the bottom and water modes (BM,WM) specified correct for the measurement application? Is an ES0 (salinity of zero) command present?

### Calibration Section

- Finally, examine the calibration section.  
(example)  
CALIBRATION  
{  
ADCP depth (.40 m)  
Heading/Magnetic offset (0.00  
0.00°)  
Transducer misalignment (0.00°)  
Intensity scale [0.43 decibels ( dB) per count]  
Absorption (0.440 dB/m)  
Salinity [0.0 parts per thousand (ppt)]  
Speed of sound correction (YES)  
Pitch and roll compensation (YES)  
Tilt Misalignment (0.00°)  
Pitch_Offset (0.000°)  
Roll_Offset (0.000°)  
Top discharge estimate (POWER)  
Bottom discharge estimate (POWER)  
Power curve exponent (0.16670)

Does the transducer draft correspond to the draft entered on the ADCP discharge-measurement notes? Have the proper offsets (if any) been entered? Is the proper estimation scheme being used for the bottom and the surface, and is the proper power-curve exponent being used?

### Transect Software Playback

When the configuration file has been verified, the Transect software data files should be loaded and replayed using the Transect software playback menu. When the playback section is first entered, the software looks for the last loaded configuration file (in TRANSECT.PTR) for information about file locations. The operator either can load a new configuration file or load an individual data file by pressing the F3 key. The operator can load a list of files from a deployment by pressing the F8 key. During playback, the data should be examined with a critical eye for the anomalies discussed in the sections below. Common sense also should be used when reviewing Transect software data files.

### Missing Ensembles

A velocity contour plot of the ADCP discharge measurement should first be examined for missing ensembles. Missing ensembles show as vertical black lines in the contour plot, as shown in figure 8.1. Figure 8.1 shows a transect containing missing

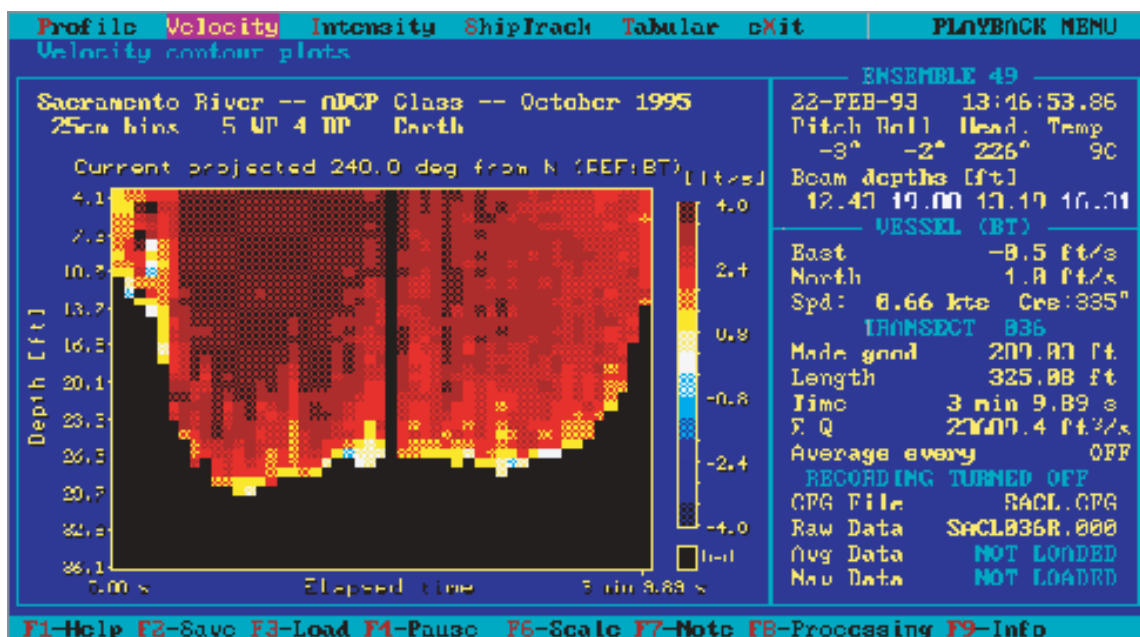

Figure 8.1. Transect containing missing ensembles caused by a loss of bottom tracking.

ensembles caused by a loss of bottom tracking. Note that, in this case, the missing ensembles would contain a significant amount of flow if they were present. The discharge calculated from the transect described above will be underestimated unless the missing data are estimated.

The following procedure can be used (using one of Transect's hidden commands) to correct transects containing bad bottom-track velocities:

- In the playback section of Transect, load the file to be used in the normal way.
- Put playback into single-step mode by toggling the F4 key, and rewind the file using the ALT W command.
- Type F6 to open the 'scale menu' and enter 7 m/s (20 ft/s) for the water-speed (current sticks) value. Type F10 to return to the main menu.
- Hit the space bar to single step through the data. Write down the ensemble number for any ensemble that has anomalously long current sticks, or high or bad speed indicated in the bottom-track portion (near the right side of the screen). After stepping through the entire file, type ALT W to rewind the file. Let's assume ensemble 40 was bad.
- Set caps lock, scroll lock, and num lock on.
- Single step through the file to the ensemble preceding the bad ensemble (39). Type CTRL-END (simultaneously). A small window will open in the upper left corner of the screen with the message ENTER ACCESS CODE:. Type 3200 then ENTER (on a laptop computer, the zero key may be remapped to another location on the keyboard as a result of pressing num lock). The bottom-track velocity now is locked into its present value. Single step to the next ensemble (40). The bottom-track velocity should be the same as the preceding ensemble (39). If the next ensemble (40) is good, open the access code window again and type 3200 to release the lock. If the next ensemble (41) is bad, continue stepping through the file until the ensemble preceding the last bad ensemble is reached and then release the lock. The locking procedure described above is then repeated until all bad ensembles have been corrected and the end of the file is reached. The total discharge will then include estimates for missing ensembles, based on extrapolated bottom-track velocities.
- Edge estimates should be done in the usual way.

The method described above should be used with caution. It only should be used to "fill in" one or two missing ensembles, at most. When the method is used, it should be so noted on the discharge-measurement log sheet and the discharge measurement should be rated accordingly. If most of the measurements collected during a measurement session contain missing ensembles, the discharges should be remeasured at a more favorable cross section (usually with slower velocities) or should be remeasured when conditions become favorable.

## Error Caused By Sediment Movement Near the Bottom

Errors caused by bottom movement generally show as negatively biased discharge measurements. These errors are introduced into the discharge-measurement cross product as apparent upstream boat movement. Sometimes the quantity of sediment moving near the bottom is enough to completely attenuate the bottom echo, causing catastrophic loss of bottom track, which shows as missing ensembles in the playback data. Figure 8.1 shows a velocity contour plot with missing ensembles caused by loss of bottom track.

When the ADCP is affected by bottom-sediment movement but has not lost bottom track, one might expect the resulting shiptrack plot to be curved in the upstream direction, even though the vessel is moving normal to the flow. In reality, the boat usually is pushed downstream by the current and, therefore, the information from the shiptrack plot can be misleading.

If bottom movement is suspected, the vessel should be anchored near the highest flow area in the cross section and data collected for at least 10 minutes. Examination of the resulting shiptrack plot will reveal the magnitude of the bottom-track error as a upstream-going shiptrack. The length of the track, in meters, multiplied by the elapsed time can be used to calculate the speed of the apparent upstream boat movement.

Figure 8.2 shows a shiptrack plot taken with the boat at anchor. The plot shows an apparent upstream boat movement of 18.7 m (61.5 ft) and an elapsed time of 612 s. This indicates an apparent velocity measurement error of 0.03 m/s (0.10 ft/s). It would be tempting to use this value to correct discharge measurements, however, the bottom probably is moving at different speeds in the cross section (slower near the edges and faster near the center, for example). A correction based on a single bottom-movement measurement would be questionable. Again, ADCP measurements sometimes can be made during conditions of bottom-sediment movement by substituting differential GPS-positioning inputs for

ADCP bottom-tracking data. See the manufacturers' web sites for information on using GPS systems for bottom tracking ([www.rdiinstruments.com](http://www.rdiinstruments.com)) and ([www.sontek.com](http://www.sontek.com)).

### Large Magnitudes of the Unmeasured Layers

Figure 8.3 shows the ending edge estimate (ALT E) screen with the show unmeasured discharge

(ALT U) switch invoked. The unmeasured discharge magnitudes near the top and bottom of the channel are summed with the measured discharge (circled area in fig. 8.3). If the magnitude of the discharge in these unmeasured areas is greater than 30 percent of the measured discharge, special attention must be paid to the applicability of the power-curve estimation scheme used. A deeper cross section should be located and used, if possible.



Figure 8.2. Transect software shiptrack plot of an anchored vessel.

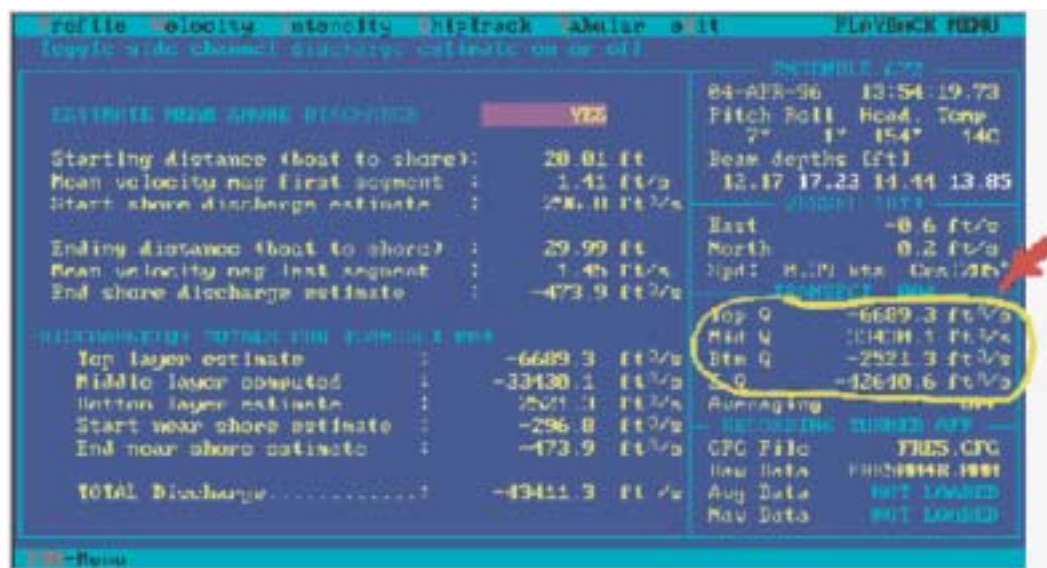

Figure 8.3. Transect software edge-value screen showing unmeasured layers.

## Low-Velocity Measurements

Most of the errors seen during Transect software playback are caused by too few ensembles being collected for a given river velocity. Even seasoned ADCP operators sometimes fall prey to this error. It cannot be over emphasized that SLOWER river traverses are BETTER when it comes to the measurement of discharge in rivers having slow mean velocities. Slow traverses allow more ensembles to be collected, thereby reducing the amount of random error in the discharge measurement. In general, the boat should traverse the river at about the same velocity as the water. In large, wide rivers, this often is not possible (or feasible), and in such cases, equation 9.1 in chapter 9 should be used to estimate the proper boat velocity. The large standard deviation of ADCP-measured (slow) velocities can be seen in the shiptrack plot of figure 8.4.

The boat speed for the traverse (fig. 8.4) was close to that of the water. Even though there was a large single-ping standard deviation, the standard deviation of the resulting group of discharge measurements was small. If any single discharge measurement has a coefficient of variation larger than 5 percent, the ADCP and boat operator should be cautioned to decrease vessel speeds during discharge measurements at the site in question for similar or lower velocities.

## Power-Curve-Fit Applicability

Figure 8.5 shows a discharge profile with measured data, cross-product curve fit, and the resulting discharge profile.

As can be seen from figure 8.5, the actual measured profile differs significantly from the one-sixth power-curve fit. In this profile, velocity near the surface is less than the velocity in the middle of the profile (as shown by the arrow). This may be caused by such things as wind shear or a flow reversal near the surface. If many or all of the measured profiles differ in this manner, then the TOP estimation scheme should be changed from POWER to CONSTANT in the configuration file, and the data replayed. The circled area indicates the profiled area where measurement bias can occur because of incorrect top layer discharge estimates. Generally, the bottom estimation scheme should be left at POWER. The exception to this rule is when significant numbers of profiles are bidirectional. A bidirectional profile is one wherein the velocities are stratified with the top-most velocities moving in a different direction than the bottom-most velocities. In cases of stratified flow, the estimation scheme should be set to CONSTANT at the top and CONSTANT at the bottom. This method will introduce some errors but the errors will not be as great as those caused by setting the estimation scheme to POWER.

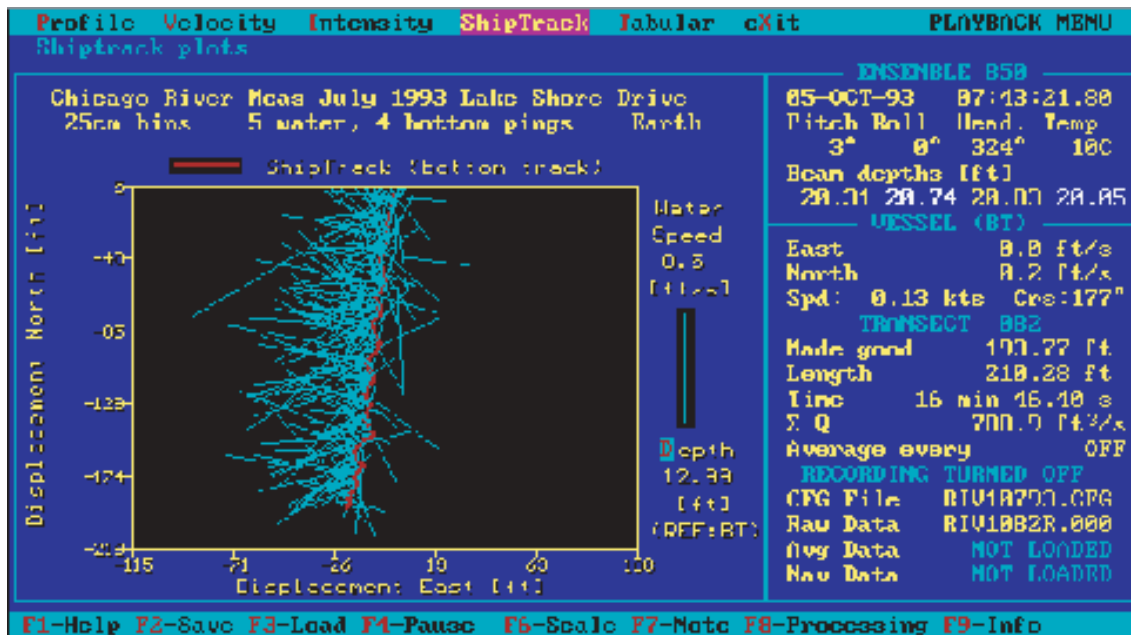

Figure 8.4. Transect shiptrack plot of acoustic Doppler current profiler-measured velocities on a slow-moving river.

## Edge Values

Figure 8.6 shows the Transect software playback edge-value estimate screen, which is accessible by pressing ALT-E after Transect playback. Note! This feature is available only during playback at this time. This menu allows the operator to insert start and end

edge distance estimates. The software then calculates an estimated discharge for each edge and adds it to the total discharge. Transect software version 2.80 (and later versions) allows the operator to enter edge values while acquiring the discharge measurement. These edge values are saved in the configuration file and can be loaded during playback.

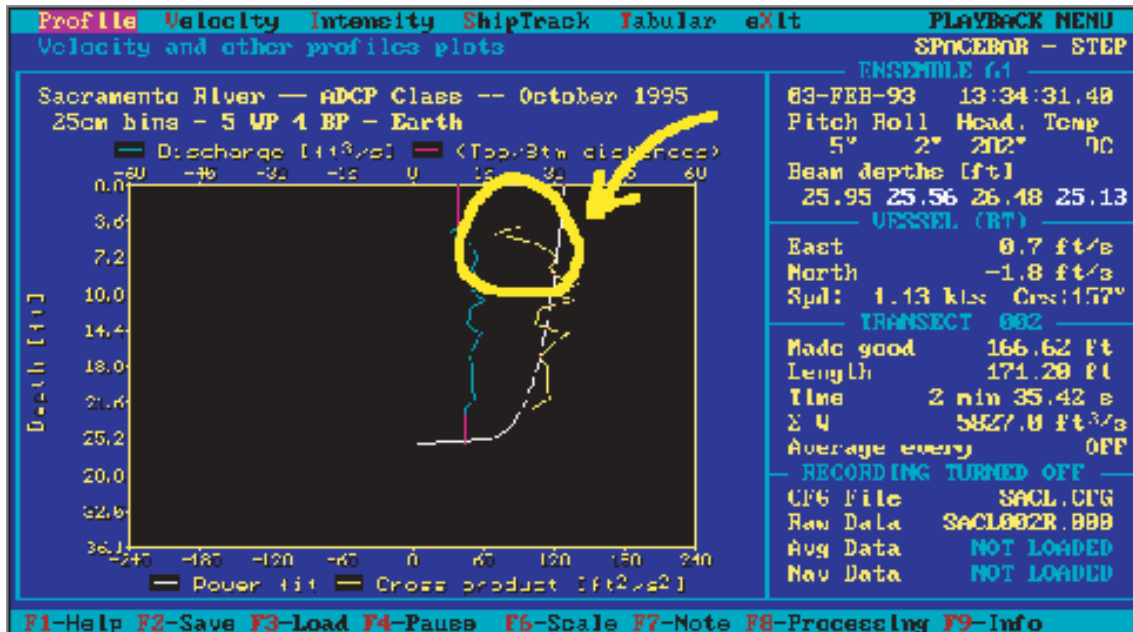

Figure 8.5. Transect software discharge profile plot. ADCP, acoustic Doppler current profiler.

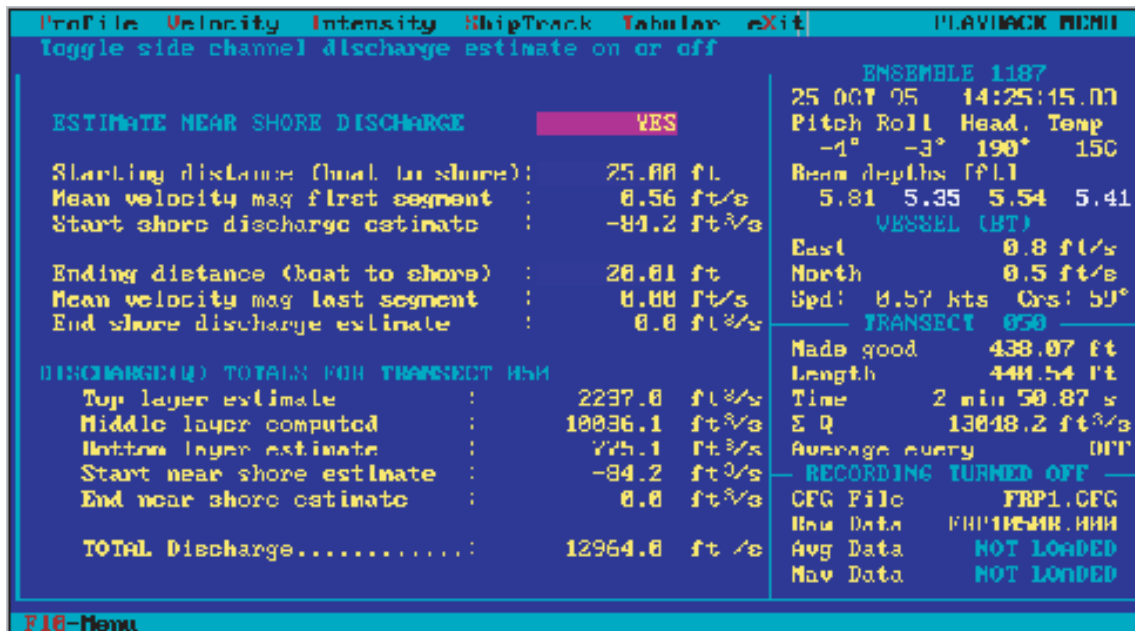

Figure 8.6. Transect software edge-value screen.

Note that in figure 8.6, the start edge-discharge estimate is negative, the main body of discharge is positive, and the end edge discharge is positive. This phenomena can be caused by two things:

- The start-edge discharge is moving in the opposite direction from the main body of discharge and the end-edge discharge [this can occur because of eddies or momentum effects (fig. 8.7)].
- Initial boat movement was toward the starting shore rather than away from it.

The sign (+ or -) assigned to the cross-product calculation is based on the boat course, in relation to the flow direction. If the water is flowing uniformly in one direction and the boat is traversing the flow uniformly without changing course, the sign of the cross product should remain constant. If the boat reverses course (or the flow changes direction during the traverse), the sign of the cross product will change. If this occurs at either or both edges, the edge velocities will have a sign that differs from that of the main flow body (fig. 8.6). In recent versions of the Transect software (version 4.00 and later), corrections have been made to eliminate incorrect signs (+ or -) near the riverbank edges, however, the operator still should carefully examine the edge-value water velocities.

## Shiptrack

The operator should take care to start the Transect software only after the boat begins the cross-

section traverse and to stop the Transect software before making the course reversal at the end of the traverse. During the discharge measurement, the ADCP operator also should note any observed longitudinal-flow reversals on the discharge-measurement log sheet. Longitudinal-flow reversals can take place at high flow (due to eddies) and near slack tide (due to momentum effects). Longitudinal-flow reversals should be noted during the review of shiptrack plots. Then the reviewer should determine whether the reversal is actual or caused by initial boat movement toward shore.

The shiptrack plot shown in figure 8.7 also should be examined for discrepancies in the motion of the discharge-measurement vessel. In general, a good discharge measurement occurs when the measurement vessel makes a smooth traverse from bank to bank. An extreme example of irregularities in the shiptrack is illustrated in figure 8.8. Examination of the velocity-profile data in figure 8.9 does not reveal these irregularities. If the shiptrack plot of this measurement had not been examined, it may have been erroneously labeled as a good measurement.

The shiptrack plot should be examined for “hooks” (fig. 8.10) near the edges that indicate that the F5 key was either pressed too early in the transect (before the vessel had started its move toward the far bank) or too late (after the boat operator has reversed course at the end of the transect). Such “hooks” can be edited out of the data using the F8 subsectioning menu (fig. 8.11).

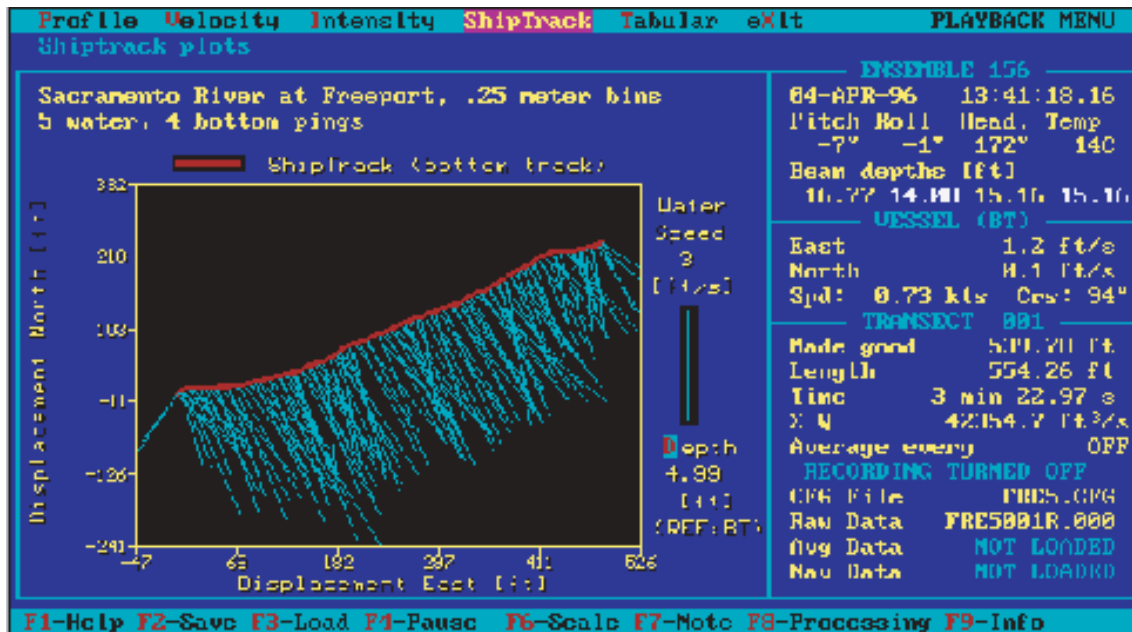

Figure 8.7. Transect software shiptrack plot.

## Summary

Transects should be replayed as soon as possible after being collected to check for possible errors in acoustic Doppler current profiler (ADCP) setup and discharge-measurement technique. Configuration files should be examined to see if proper ADCP setup parameters were used for the measurement. The power-curve estimation scheme should be checked for

correctness and the edge-value estimates should be checked.

Discharge-measurement technique should be checked for correctness. In particular, the boat speed should be slow enough to reduce the discharge-measurement standard deviation to a value under 5 percent (of mean discharge). In tidally affected areas or large shallow, slow-moving rivers, equation 9.1

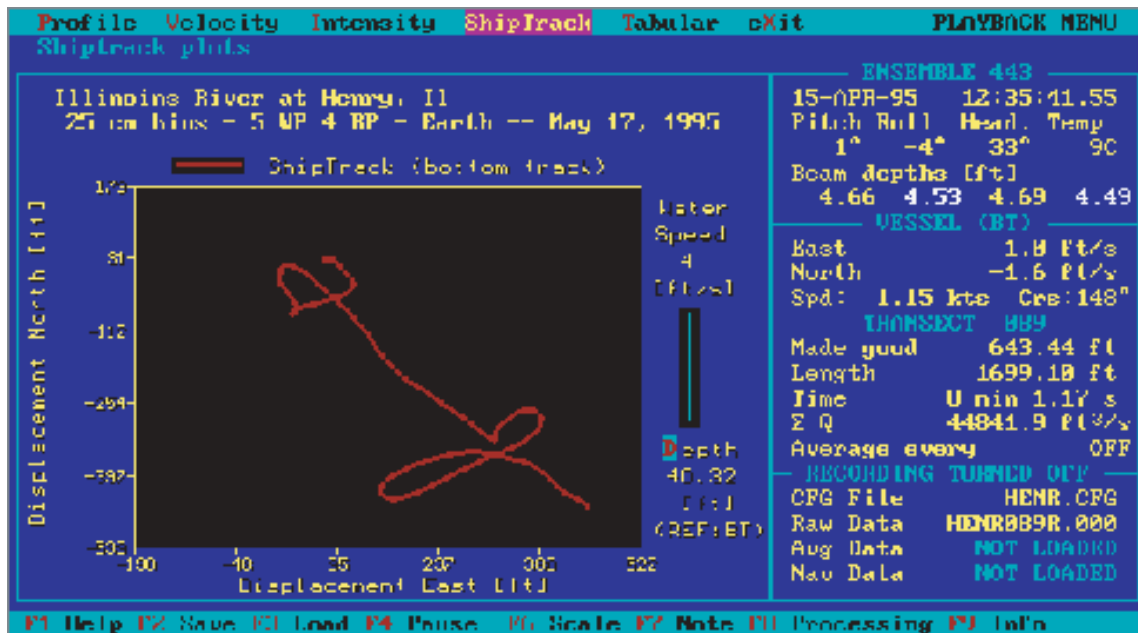

Figure 8.8. Transect software shiptrack plot with operator's initials.

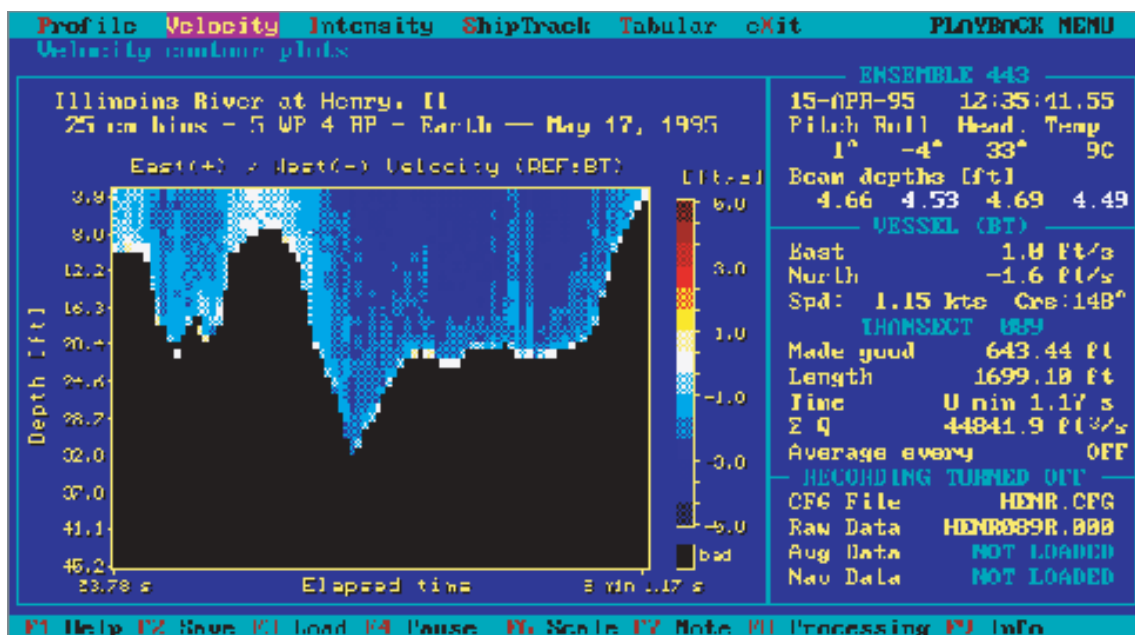

Figure 8.9. Transect software profile plot of "initials".

(chap. 9) can be used to assess discharge-measurement standard deviation.

If bottom movement is suspected, the boat should be anchored in an area of the highest channel flow and transects should be collected for at least 10 minutes. The resulting shiptrack plot should be examined for apparent upstream boat movement.

If a few missing ensembles are discovered during playback, they can be estimated using the technique

described in this chapter. If there are many missing ensembles present in the transect data, the discharges should be remeasured at a different cross section or when conditions become more favorable.

Magnitudes of the discharges in the unmeasured layers should be examined and, if they comprise a significant portion of the total discharge, the operator should attempt to locate a deeper cross section for future measurements.



Figure 8.10. Transect shiptrack screen. ADCP, acoustic Doppler current profiler.



Figure 8.11. Transect subsectioning menu screen.



This page left blank intentionally.

## CHAPTER 9: DISCHARGE-MEASUREMENT ERROR

### Side-Lobe Interference

In this chapter we will discuss the major sources of error in ADCP discharge measurements. We will first review velocity-measurement uncertainty (chap. 1) and then discuss random and systematic ADCP discharge-measurement errors. A simple discharge-measurement error model is presented to aid the operator in premeasurement planning and error assessment.

### A Review of Major Acoustic Doppler Current Profiler Velocity-Measurement Limitations and Uncertainties

A short review of ADCP velocity-measurement uncertainty and measurement limitations will help in understanding discharge-measurement errors. Detailed explanations and examples of these uncertainties are discussed in chapter 1.

#### Limitations

##### Range Limitations

The signal strength of an acoustic pulse decreases logarithmically with distance from the transducer face (range). As the signal strength and signal-to-noise ratio decreases, the spectral width of the returned signal increases. This increase in spectral width with range causes an increased standard deviation of the measured velocity with range. At some range the return echo is unusable. This limiting range is largely dependent on transducer frequency and, to a much lesser extent, on transmit pulse length and beam angle for any given ADCP. The usable range of an ADCP also is affected by the number of scatterers in the water column. Below is a conservative estimate of ADCP maximum range for several transducer frequencies (table 9.1).

**Table 9.1.** Approximate maximum depth range for 300-, 600-, and 1,200-kilohertz acoustic Doppler current profiler (ADCP) systems

[kHz, kilohertz; m, meter; ft, foot]

ADCP frequency (kHz)	Range (m) (ft)
300	20 m (390 ft)
600	48 m (157 ft)
1,200	15.4 m (50.5 ft)

When a parasitic side lobe strikes the bottom, the returning echo drowns out the reception of the echo from the main beam. In an ADCP with 20°-beam angles, this loss of reception occurs at a point equal to about 94 percent of the total depth. This area of side-lobe interference near the bottom (equal to 6 percent of total depth) can be calculated using equation 1.4. Using this equation, the Transect program “throws out” discharge data in the area of side-lobe interference and then estimates the velocities near the bottom using power-curve fits or other estimation techniques. However, if the operator is collecting velocity profiles, the velocities may not be flagged “bad” by the Transect software. To determine the depth at which the side-lobe interference will affect the data, the operator must examine backscattered intensities. In a normal profile, the backscattered intensities start at around 140 counts (or higher) and “drop off” with depth. Velocity measurements become questionable at the point where intensities increase (or stop decreasing). Looking at beam 1 in the tabular plot in figure 9.1, we see that the intensities start at 145 and increase to 147 in the following bin because of ringing (mechanical and electronic resonance). This error in the top-most bin occurs if the blanking distance is set too short (see the next section on Blanking Distance). The intensities decrease until about 123 counts where they “flatten” and then begin to increase. The depth at which the counts flatten and do not decrease is the depth at which the velocities may become affected by side-lobe interference. The area between the last good bin center and the bottom must be estimated by some means to obtain mean velocity in the vertical profile.

##### Unmeasured Velocity Due to Blanking Distance and Transducer Draft

After transmitting the acoustic signal, the ADCP transducers and electronics must “recuperate” briefly before they can receive the incoming echoes. During recuperation, the acoustic signal travels a short distance (blanking distance). Acoustic reflections cannot be received within the area between the transducer face and the blanking distance.

The transducer assembly must be submerged adequately so that it does not break the water surface during pitch and roll events. The depth of the transducer faces below water surface is called transducer draft.

To calculate the distance to the center of the first bin, it is necessary to use the BB-SETUP software module, available from RDI, as part of the Transect software package. From the screen capture shown in figure 9.2 it can be seen that if you are using a

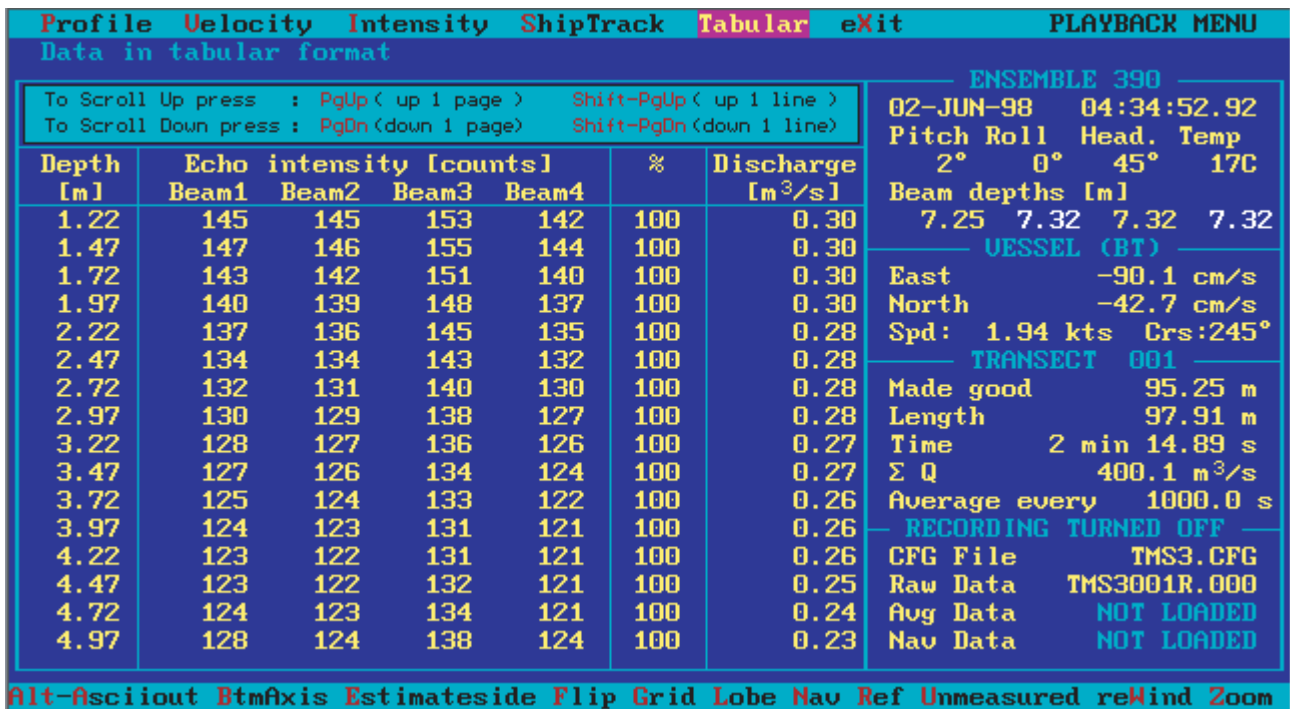

Figure 9.1. Screen shot of Transect software showing tabular output.

1,200-kHz BB-ADCP with 0.25-m (0.82-foot) bins, a blanking distance of 0.5 m (1.64 ft) and an ambiguity velocity (WV) of 190 cm/s (6.2 ft/s), the center of bin 1 will be at a range of 0.85 m (0.28 ft) from the face of the transducers. If the transducer draft is 0.25 m (0.82 ft), the center of the first bin is 0.85 + 0.25 = 1.10 m (3.6 ft) below water surface. Water velocity in the area between the water surface and the first bin center must be estimated to calculate mean water velocity in the vertical profile.

### Random and Systematic Uncertainty

In chapter 1, we discussed ADCP velocity-measurement uncertainty in detail. In the following paragraphs we will touch on each of the major sources of ADCP velocity-measurement uncertainty so that we can more readily grasp the causes of discharge-measurement error.

ADCP velocity-measurement uncertainty can take two forms:

- Random uncertainty
- Systematic uncertainty (bias)

Random uncertainty can be reduced by data averaging, but systematic uncertainty cannot. If the magnitude of systematic uncertainty is known, it can sometimes be corrected using adjustment factors or coefficients.

### Random Uncertainty Due to Self Noise and Lag Distance

The most significant source of random uncertainty in a BB-ADCP water-velocity measurement is caused by self noise (freeway analogy in chap. 1). The magnitude of this uncertainty is affected by ADCP transducer frequency, transmit pulse width, lag distance, and many other factors. This uncertainty directly affects ADCP water-velocity measurement precision. Techniques such as pseudo random phase encoding, data averaging, and increasing the lag distance are used to help reduce the effects of this uncertainty. The magnitude of this uncertainty can be predicted using the BB-SETUP program that is shipped with the Transect software files. Figure 9.2 shows a screen shot of a typical 1,200-kHz broad-band ADCP setup scenario.

In mode 1 operation, the operator can control the lag distance by changing the value of the ambiguity velocity (WV command). Notice that for an ambiguity velocity of 190 cm/s the single-ping standard deviation (an indicator of velocity-measurement random uncertainty) is 14.08 cm/s (0.46 ft/s). If the operator lowers the ambiguity velocity to 90 cm/s (2.95 ft/s) for example, the single ping standard deviation drops to 10.3 cm/s (0.34 ft/s). There are practical upper and lower limits to the ambiguity-velocity setting; setting the ambiguity velocity too high will produce unacceptable random uncertainty in the velocity measurement and setting the ambiguity velocity too low may introduce ambiguity uncertainty (chap. 1). In

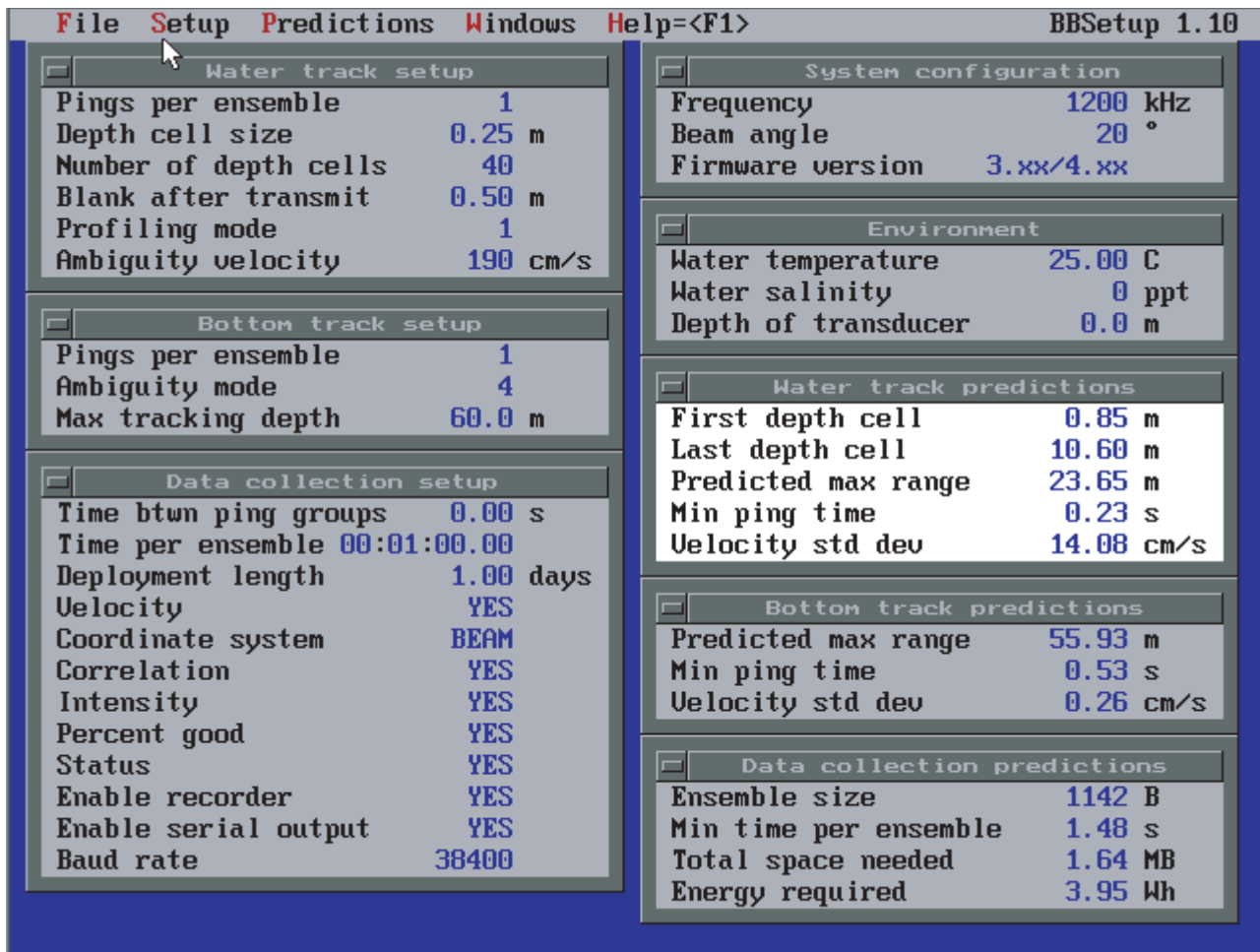

**Figure 9.2.** Screen shot of BB-SETUP software showing a typical setup for a 1,200-kilohertz broad-band acoustic Doppler current profiler.

mode 5 operation, the velocity-measurement uncertainty is greatly reduced (by about a factor of 10) because of the large lag spacing. However, because this large lag spacing lowers the ambiguity velocity, mode 5 only can be used in conditions where the bottom and water velocities are low [less than 50 cm/s (1.64 ft/s)], relative to the ADCP.

#### Systematic Uncertainty Due to Velocity Ambiguity

If the operator is recording single-ping ensembles, velocity-ambiguity uncertainties show as “spikes” in the data that are the opposite sign of the “true” velocity. The difference between the “true” velocity and the erroneous velocity is twice the magnitude of the ambiguity velocity (WV command in mode 1). A detailed explanation of this uncertainty is in chapter 1. For mode 1 operation, the operator can raise the value of the ambiguity velocity to eliminate these uncertainties, but the single-ping velocity-measurement standard deviation will increase, causing decreased measurement precision. The ambiguity-

velocity setting is a trade off and usually can be set to a “safe” value using equation 3.1 in chapter 3. If the ambiguity-velocity values are set to a high value because of possible ambiguity uncertainties, the operator may have to slow the boat during the cross-section traverse to improve the discharge-measurement standard deviation (discussed later in this chapter).

For mode 5 operation, the ambiguity velocity (WZ command) is set automatically by the ADCP, depending on water depth and depth-cell length. If, during mode 5 operation, ambiguity uncertainties are encountered, the operator either must switch measurement modes or look for a cross section having lower velocities and (or) current shear.

#### Systematic Uncertainty in Speed of Sound Due to Temperature

Speed-of-sound calculations that are not corrected for temperature can cause velocity-measurement errors and depth errors as great as 7 percent. Fortunately the Transect software uses data from a thermistor in the transducer assembly to correct

speed-of-sound calculations for temperature variations in the water near the transducer. Under normal stream conditions, this correction reduces speed-of-sound errors to insignificant levels. Sometimes, however, the water column becomes temperature stratified. Unlike horizontal water-velocity errors, depth-measurement errors can be introduced by temperature gradients in a stratified water column. Figure 9.3 shows depth errors, in percent, due to improper temperature compensation for speed of sound. Fortunately temperature gradients must be extremely high (10°C or more) to cause a significant error in a BB-ADCP depth measurement. Gradients of this magnitude sometimes can occur during the summer in slow-moving water.

Speed-of-sound errors also can be caused by a faulty thermistor in the transducer assembly. An error in temperature causes an erroneous calculation of water density, which results in a speed-of-sound uncertainty.

#### Systematic Uncertainty in Speed of Sound Due to Salinity

The speed-of-sound equation in the Transect program (R.D. Instruments, Inc., 1995) depends on a user-supplied salinity value to calculate speed-of-sound corrections (as discussed in the velocity-measurement error section in the first part of this chapter). This value is specified in the Transect software configuration file. If the operator has entered an incorrect value or has forgotten to enter the proper value, depths (as well as velocities) are calculated incorrectly. Depth errors as high as 3 percent can be caused by speed-of-sound calculations that are not corrected for salinity (fig. 9.4). Fortunately “ball park” salinity values usually will reduce this error to less than 1 percent.

Velocity errors due to salinity-caused speed-of-sound variations can be at least as serious, therefore, many boat operators carry a salinimeter (or conductivity meter) with them to the discharge-

measurement site. Salinity can be calculated and entered into the configuration file prior to the discharge measurement, however, a better approach is to enter zero salinity into the configuration file (ES0). The correct salinity can be plugged into the configuration file during playback. An incorrectly entered salinity using the ES direct command can be very hard to correct after the fact.

#### Systematic Uncertainty Due to Incorrect Beam Geometry

The largest source of systematic uncertainty in an ADCP is caused by uncorrected errors in the measurement of the beam-pointing angles. These uncertainties usually are in older BB-ADCP units that were sold before the manufacturer instituted stringent quality-control procedures. Late model BB-ADCPs and Workhorse Rio Grandes have transducer assemblies that meet more exacting beam-angle tolerance requirements. Each ADCP is tested on a distance course and corrections are saved in the ADCP firmware for any measured beam-angle discrepancies. Older ADCPs can be upgraded by the manufacturer and then tested in a lake to identify and correct beam-angle uncertainties.

#### Minimizing Uncertainty in Velocity Profiles

Many scientific studies require accurate water-velocity profile measurements and discharge measurements. Many of the velocity-measurement errors described above can be minimized or eliminated by using the following common sense rules:

- Use the proper water mode for the job. If the velocities are dynamically changing, or the vessel is affected by pitch and roll, use water mode 1. In shallow water that is placidly moving, mode 5 may be used. In shallow, fast-moving water, mode 8 may be used.

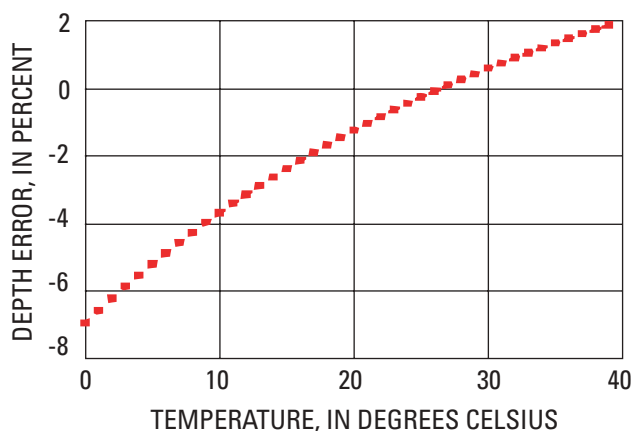

**Figure 9.3.** Depth error due to speed of sound that is uncorrected for temperature.

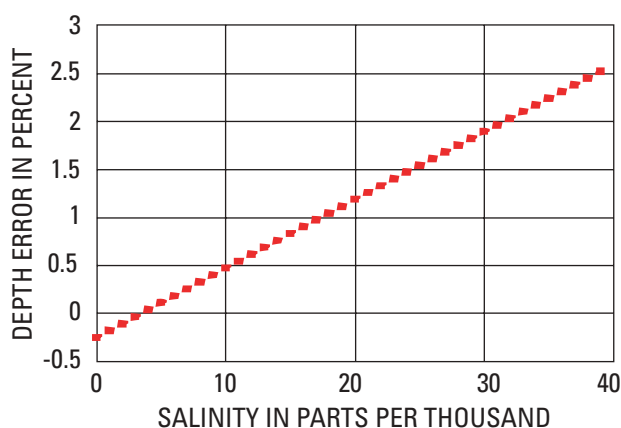

**Figure 9.4.** Depth error due to speed of sound that is uncorrected for salinity.

- Collect enough data at the profile location to ensure that the measured water-velocity standard deviation is within usable limits (after the data are averaged).
- If the unmeasured bottom and top velocities are to be estimated, ensure that the measured portion of the profile (after averaging) is congruent with the estimation scheme used. For example, if the measured part of the profile is bidirectional, a one-sixth power-curve estimation scheme is improper.

## Errors Affecting the Accuracy of Discharge Measurements

If heavy sediment loads are not present and a moving river bed problem does not exist, errors in ADCP discharge measurements usually are caused by improper river traverse rates or erratic movements of the discharge-measurement vessel. These random errors usually cause imprecision in the discharge measurement (scatter). Reducing the traverse rate and eliminating erratic vessel movements can reduce random error.

The next most common error types are depth errors caused by incorrect transducer draft, depth errors due to speed-of-sound variations, and cross-product errors due to improper application of the power-curve fitting scheme. These sources of error are biases that cannot be improved by slowing the traverse rate or averaging the data (see bias error section later in this chapter). Random errors in discharge measurements made with the BB-ADCP system roughly can be predicted if the following values are known:

- ADCP water-velocity measurement precision
- ADCP bottom-track velocity measurement precision
- The standard deviation of naturally occurring water-velocity pulsations (at the ADCP-measurement time scale)
- Approximate average cross-sectional water depth
- Approximate average water speed
- BB-ADCP bin size
- BB-ADCP ping rate

Table 9.2 gives the approximate depth-averaged, water-velocity standard deviation for 1,200-, 600-, and 300-kHz BB-ADCPs with 20° beam angles using mode 1 operation with an ambiguity velocity of 190 cm/s (6.23 ft/s).

Mode 5 bottom-track standard deviation is much less than the water-velocity standard deviation for all ADCP frequencies [0.2–0.3 cm/s (0.006–0.009 ft/s)].

**Table 9.2.** Approximate depth-averaged single-ping precision for 1,200-, 600-, and 300-kilohertz broad-band acoustic Doppler current profiler-measured water velocities using mode 1 operation, 20° beams, and WV190

[kHz, kilohertz; m, meter; ft, foot; cm/s, centimeter per second; ft/s, foot per second]

Frequency (kHz)	Depth cell size	Average standard deviation for depth range
1,200	0.25 m (0.8 ft)	14.1 cm/s (0.46 ft/s)
600	.50 m (1.64 ft)	14.1 cm/s (.46 ft/s)
300		14.1 cm/s (.46 ft/s)

### Simplified Random-Error Model

The precision of a discharge measurement may be computed using the following algorithm in equation 9.1:

$$\sigma_q = \frac{\sqrt{\left[ \left( 100 \frac{X_w}{V_m} \right)^2 + \left( 100 \frac{X_b}{V_m} \right)^2 + \sigma_p^2 + \sigma_z^2 \right]}{\sqrt{0.75 N_b N_s}} \quad (9.1)$$

where

- $\sigma_q$  = standard deviation of discharge measurement, in percent;
- $V_m$  = estimated approximate mean stream velocity, in centimeters per second;
- $X_w$  = BB-ADCP water-velocity precision, in centimeters per second (table 9.2.);
- $X_b$  = BB-ADCP bottom-track precision, in centimeters per second (table 9.2.);
- $\sigma_p$  = estimated standard deviation of natural pulsations, in percent of mean velocity; a value of usually 8–12 percent (at the time interval used for an ensemble by the BB-ADCP);
- $\sigma_z$  = depth error due to round off and resolution limitations;
- $N_b$  = average number of bins in the vertical; and
- $N_s$  = total number of subsection measurements.

Equation 9.1 is derived using the following assumptions:

- A 15-percent bin-to-bin correlation
- A 0-percent subsection-to-subsection correlation
- A smooth rectangular channel

The 0.75 constant in equation 9.1 is a rough approximation of the Markov model output when there is a sample (bin-to-bin) correlation of 15 percent (Matalas and Langbein, 1962). Matalas and Langbein (1962) present an equation for the calculation of effective N for any correlation coefficient, and this equation should be used in error models that are developed for the estimation or prediction of BB-ADCP (or narrow-band ADCP system) discharge-measurement error.

Depth error due to BB-ADCP round off and resolution limitations ( $\sigma_z$ ) is estimated by the manufacturer to be 4 percent of the measured vertical depth range on an individual beam (Joel Gast, R.D. Instruments, Inc., oral commun., 1997). Because four beams are averaged for the depth measurement, the error becomes  $\frac{4}{\sqrt{4}} = 2$  percent for each ping averaged during the discharge measurement.

Figure 9.3 shows graphs of mode 1, 1,200-kHz, error model output for a 61-m- (200-foot-) wide river, with boat speeds of about 0.3 and 0.9 m/s (1.0 and 3.0 ft/s). Figure 9.3 reveals that a boat operator traversing a 61-m- (200-foot-) wide, 4.6-m- (15-foot-) deep river could use a boat speed of about 0.3 m/s (1 ft/s) for the measurement of all mean river velocities above 0.15 m/s (0.5 ft/s). Figure 9.5 also shows that discharge-measurement error increases with the boat speed. This increase occurs because the BB-ADCP is collecting fewer pings during the cross-section traverse, with a resultant increase in random error (because fewer data are averaged). The boat operator must remember that the precision of a discharge measurement can change dramatically with changes in the total number of pings and the total number of bins sampled during the traverse. The total number of depth bins depends on the water depth. Figure 9.6 shows the same scenario as in figure 9.5, but with an average cross-section depth of 9 m (30 ft) rather than 4.3 m (15 ft). Note that the discharge-measurement error decreases to magnitudes similar to those shown in figure 9.5. This decrease occurs because there are twice as many bins averaged in the vertical profile.

Although equation 9.1 can be programmed into a spreadsheet and used to predict discharge-measurement uncertainty, a small executable software application (QERROR) has been developed (for mode 1 use) that is more easily used in the field. Figures 9.7–9.9 show screen shots from the QERROR application. Figure 9.7 shows the input screen. The measurement units are in mixed systems on the input screen for two reasons:

- USGS field office personnel are more adept at estimating widths and depths in the standard-measurement system.

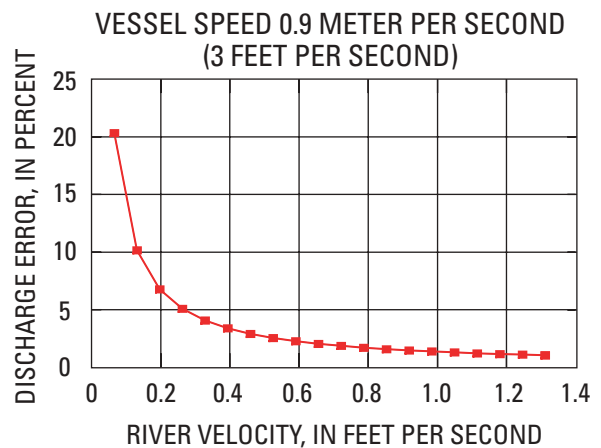
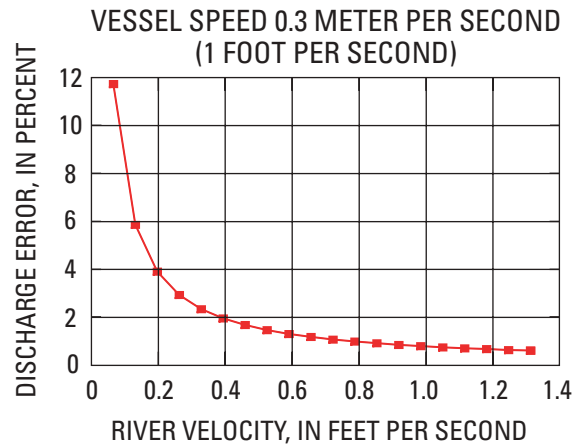

**Figure 9.5.** Discharge error using a boat speed of about 0.3 meter per second (1 foot per second) and about 0.9 meter per second (3 feet per second).

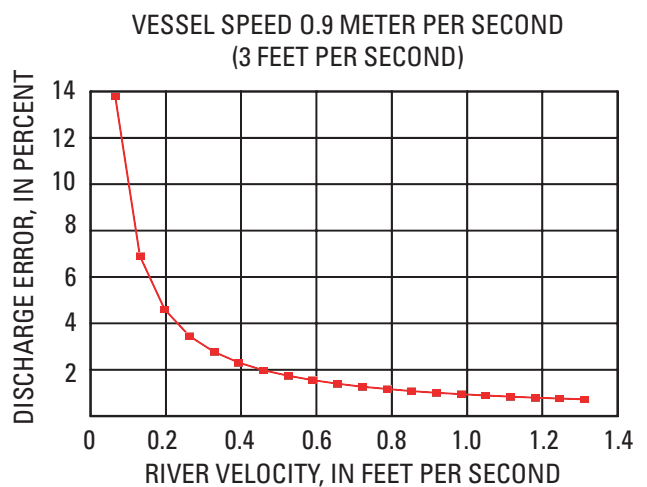

**Figure 9.6.** Discharge error using a boat speed of about 0.9 meter per second (3 feet per second) in 9 meters (30 feet) of depth.

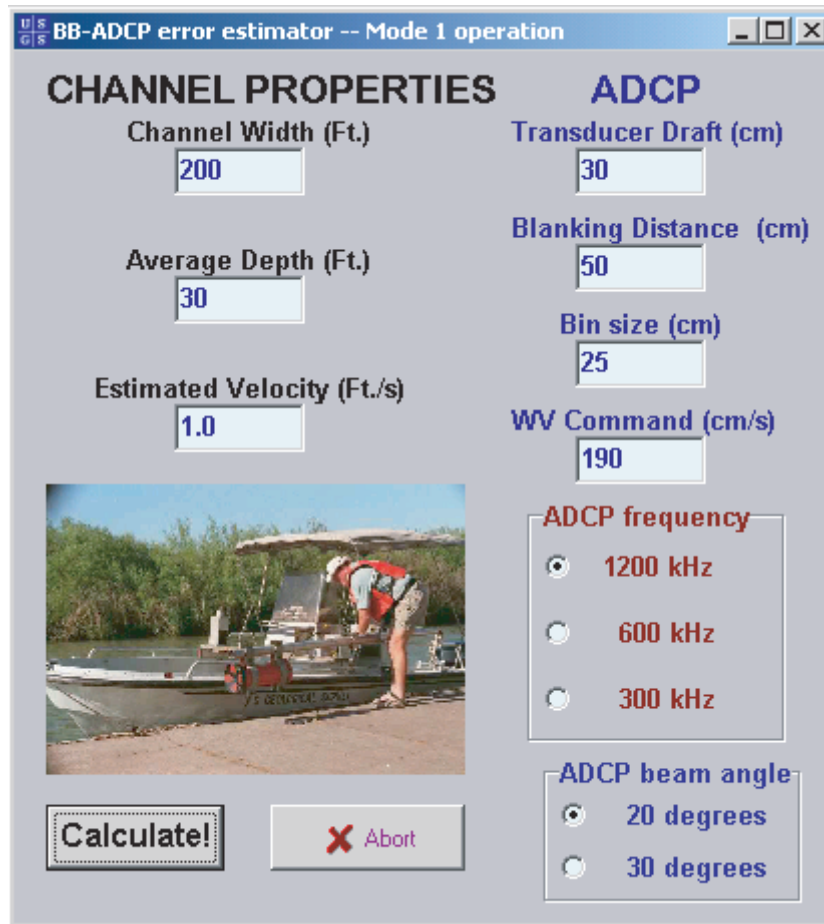

Figure 9.7. QERROR setup screen. ADCP, acoustic Doppler current profiler.

- ADCP input parameters always are requested in SIS units.

Figure 9.8 is the output screen from the QERROR application and it illustrates the importance of slow-vessel traverse rates when measuring rivers with slow mean velocities. Note that the error is reasonable when the boat is moving at speeds less than, or equal to, the water velocity. A good rule of thumb is to traverse the river at about the same speed as the mean water velocity. However, this rule becomes inapplicable when measuring wide, deep rivers, with slow water velocities. The operator would not be able to complete such a measurement within a reasonable time frame. In cases of wide, deep rivers, the operator can use equation 9.1 or the QERROR application to estimate discharge-measurement error based on boat speed, average water depth, and estimated mean water velocity.

Figure 9.9 shows the same measurement scenario as used for figure 9.8 with a mean river velocity of 0.15 m/s (0.5 ft/s). Notice that boat speeds

as high as 0.6 m/s (2 ft/s) could be used for accurate measurement of the above described river, partly because the river (figs. 9.6 and 9.7) is 9 m (30 ft) deep. If the river depth were shallow [3 m (10 ft) or less], the boat would have to be slowed to the mean water velocity to maintain a reasonable precision (a CV of less than 5 percent) (fig. 9.10).

Examination of fig. 9.6 reveals that the length of time required for the river traverse increases exponentially as mean river velocities approach 0. The requirement for this extended averaging period begins to defeat the purpose of the BB-ADCP measurement system at very shallow depths and low velocities. Water mode 5 should be used, if possible, in these cases because it will reduce the above described discharge-measurement errors by almost an order of magnitude, however, its use is limited to rivers having little shear or turbulence. For 600-kHz BB-ADCPs, water mode 8 can be useful in shallow water if the vessel is slowed to reduce the higher random error of mode 8 operation.



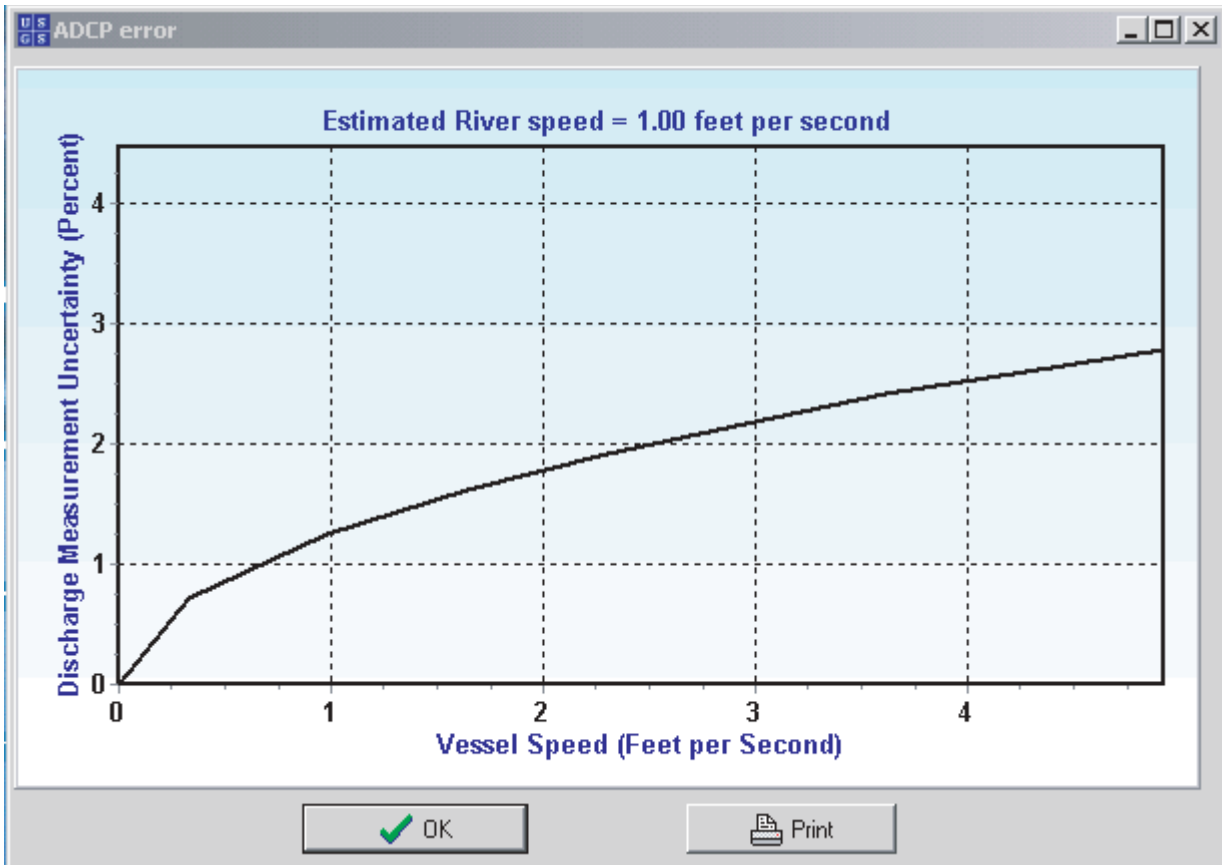

**Figure 9.8.** Discharge error with a mean water velocity of about 0.3 meter per second (1.0 foot per second). ADCP, acoustic Doppler current profiler.

### Bias Error

Discharge-measurement random error can be reduced by data averaging (slowing the vessel speed for the measurement transect), as discussed above. Bias (systematic) errors cannot be reduced by data averaging.

Bias error can be separated into two classes: instrument error and operator error. Instrument error is due to physical, electrical, or acoustical limitations of the BB-ADCP instrument (or defects in the BB-ADCP hardware and firmware). Operator error is caused by improper BB-ADCP installation, setup, and, in some cases, application.

#### Instrument-Caused Bias Error

There are many sources of instrument bias error. Some are more significant than others. This report will not attempt a discussion of ADCP systematic error sources related to the physics of the acoustic signal (other than beam-pointing angles and depth measurements) because many of these sources are not yet documented and are beyond the scope of this report.

The manufacturer is aware of many of these types of errors and reports that the two most important of these are water-velocity measurement errors, due to selective absorption (nonuniform signal absorption in the water mass over the transmitted signal spectrum), and bottom-track errors due to terrain effect (the leading edge of the acoustic beam is far20ther away from the transducer than is the trailing edge when it impinges the channel bottom). These and other errors are thought by the manufacturer to be small and insignificant for most applications (Joel Gast, R.D. Instruments, Inc., oral commun., 1992). The following paragraphs will discuss or revisit instrument errors that significantly can affect the accuracy of an ADCP discharge measurement. These errors are as follows:

- Beam-angle errors.
- Depth-measurement errors.
- Speed-of-sound errors due to temperature and salinity.
- Bias errors caused by improperly estimating the unmeasured portions of the cross section.
- Operator-caused bias errors.

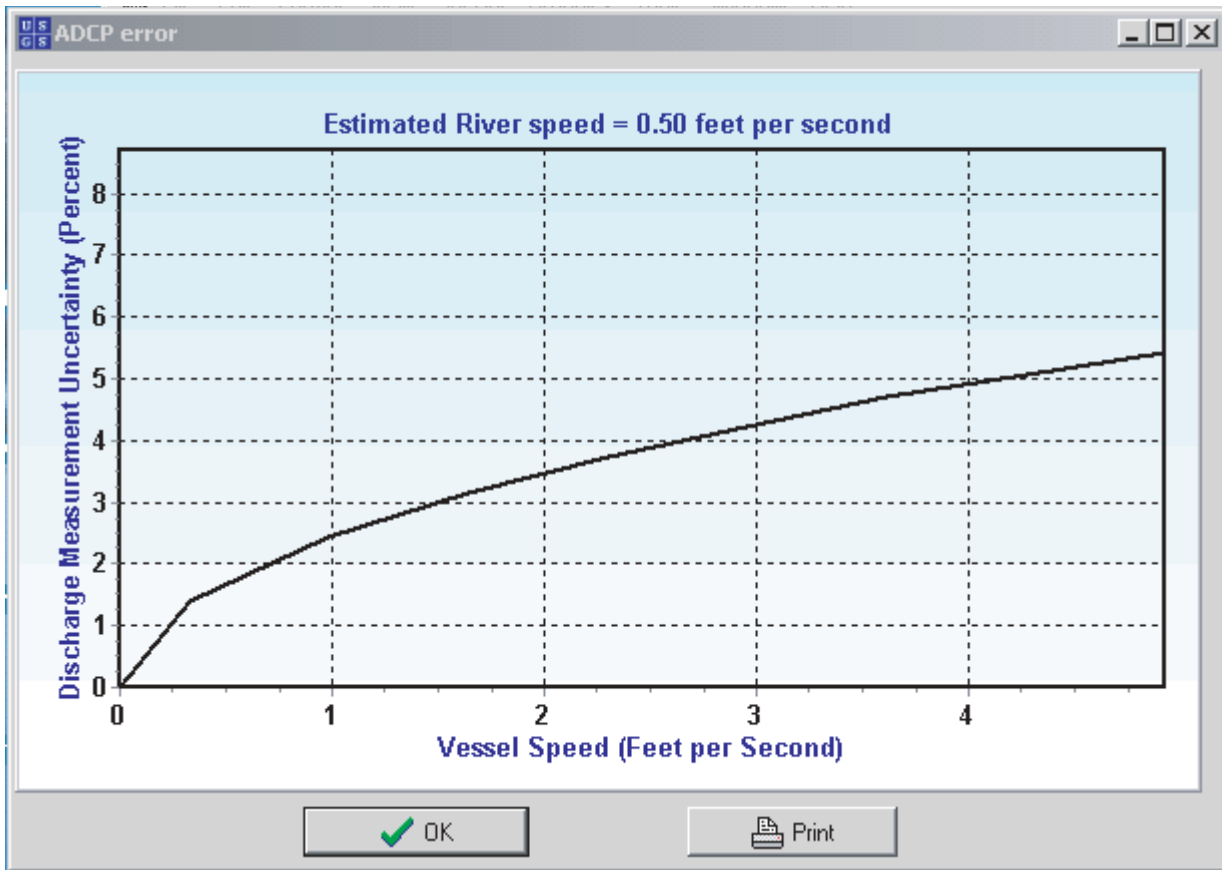

**Figure 9.9.** Discharge error in deep water [9 meters (30 feet)] with a mean river velocity of about 0.15 meter per second (0.5 foot per second). ADCP, acoustic Doppler current profiler.

#### Beam-Angle Errors

Errors in the beam-pointing angles (discussed in the velocity-error section) have an equivalent affect on the accuracy of discharge measurements.

#### Depth-Measurement Errors

The Transect software uses depth measured from the four acoustic beams to calculate mean depth for each discharge-measurement subsection. These depth-measurement errors can come from two sources:

- Depth sampling errors due to limitations of the acoustic beams and bin sizes.
- Depth errors due to improper estimation of speed of sound.

Figure 9.11 shows an exaggerated instance of depth error due to limitations of the acoustic beams. If only a few depth measurements were taken, per cross-section traverse, this type of error would be significant. However, the averaged depth is calculated using all four beam depths for each ensemble and, if the ensembles are kept short enough, the mound (fig. 9.8) will be integrated into the total cross-section averaged depth. A

typical BB-ADCP discharge measurement collects many more depth measurements during the cross-section traverse than are collected using conventional methods.

Near the bank edges, the BB-ADCP beams oriented toward shore will show shallow depths, whereas the beams oriented toward the channel will show greater depths. An average of all four beams will approximate the vertical depth from the center of the BB-ADCP transducer assembly to the bottom. In pitch and roll conditions, averaged depth measurements from all four acoustic beams will be more accurate than depths measured by a single, vertically placed, depth sounder because of the large beam “footprint” or pattern.

#### Speed-of-Sound Errors Due to Temperature and Salinity Gradients

Speed-of-sound errors (discussed in the ADCP Velocity-Measurement Limitations and Uncertainties section of this chapter) affect the accuracy of discharge measurements in the same way that they affect the accuracy of velocity measurements. These uncertainties

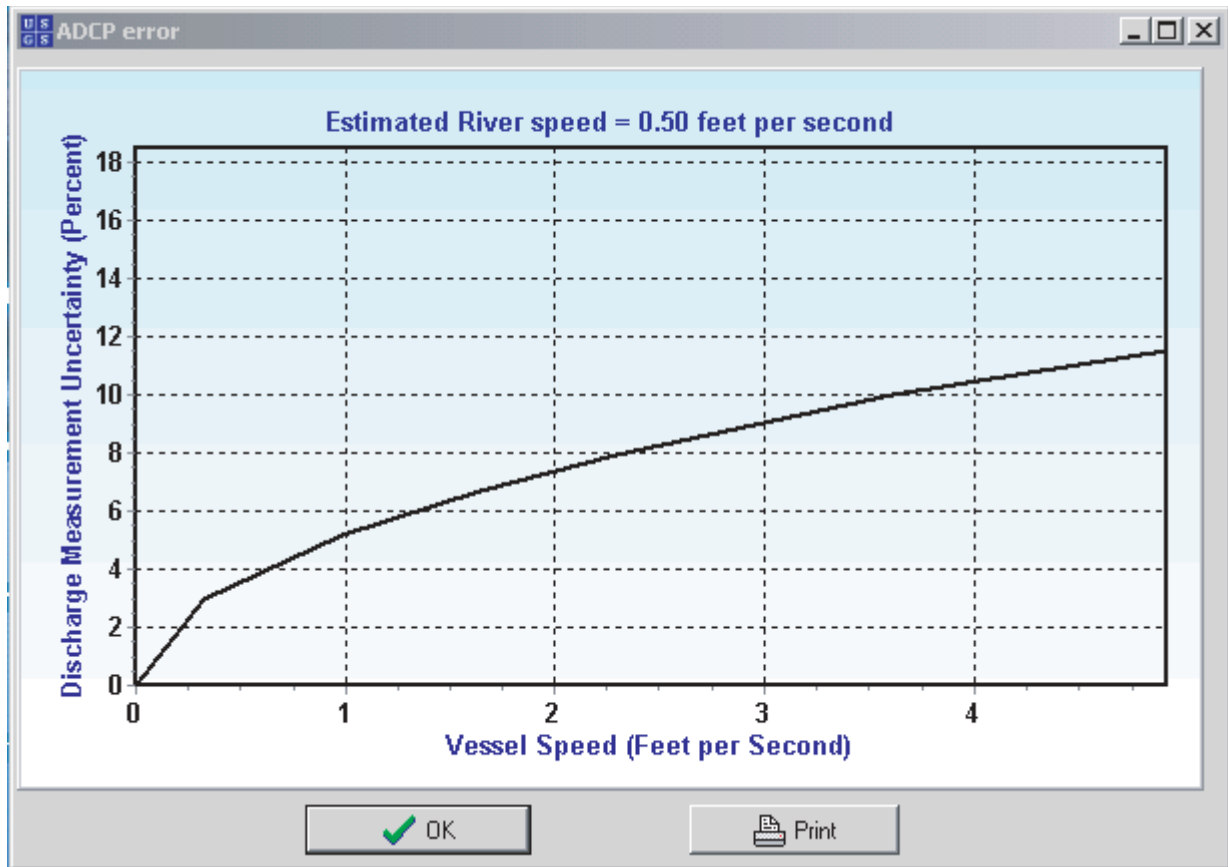

**Figure 9.10.** Discharge error in shallow water [3 meters (10 feet)] with a mean river velocity of about 0.15 meter per second (0.5 foot per second). ADCP, acoustic Doppler current profiler.

are subtle and hard to spot in the collected data. Close attention to detail is required by the ADCP operator to eliminate speed-of-sound uncertainties.

**Bias Error Due to Incorrect Estimation of Unmeasured Velocities Near the Water Surface and Channel Bottom**

Errors of this type are called extrapolation errors. An example of a nonstandard velocity profile is shown in chapter 8 to illustrate this error. The extrapolation scheme used to estimate cross products near the water surface and channel bed assumes a “Manning-like” velocity profile. The unmeasured area near the bottom usually is not a problem because the velocity must go to zero at some point close to the bed. However, the unmeasured area near the water surface is problematic, particularly in wind-affected cross sections and in estuaries. Wind effects can cause nonstandard profiles that are significantly biased (near the water surface). In these cases, the POWER estimation scheme (used in the Transect program) can be changed to CONSTANT.

In the estuaries and other backwater-affected sites, gravitational circulation sometimes can cause

nonstandard profiles as well as bidirectional flow. Examination of the Transect program playback files can sometimes reveal nonstandard profiles and can provide the basis for a revised power-fit coefficient (chap. 8). In cases of bidirectional flow, the estimation scheme should be changed to CONSTANT on the bottom and CONSTANT at the surface because a power function extrapolation mathematically cannot cross zero. In bidirectional flows, the velocities may be positive (flowing downstream) in the upper portion of the water column and be negative (flowing upstream) in the lower portion of the water column.

Fortunately, extrapolation errors can be corrected during data playback. The raw recorded data are not affected by changing the extrapolation scheme, and the operator and office analyst can use trial-and-error techniques to reduce bias error that is due to incorrect estimation of unmeasured cross products.

**Operator-Caused Bias Error**

Operators can introduce a number of bias errors affecting a discharge measurement. Many of these

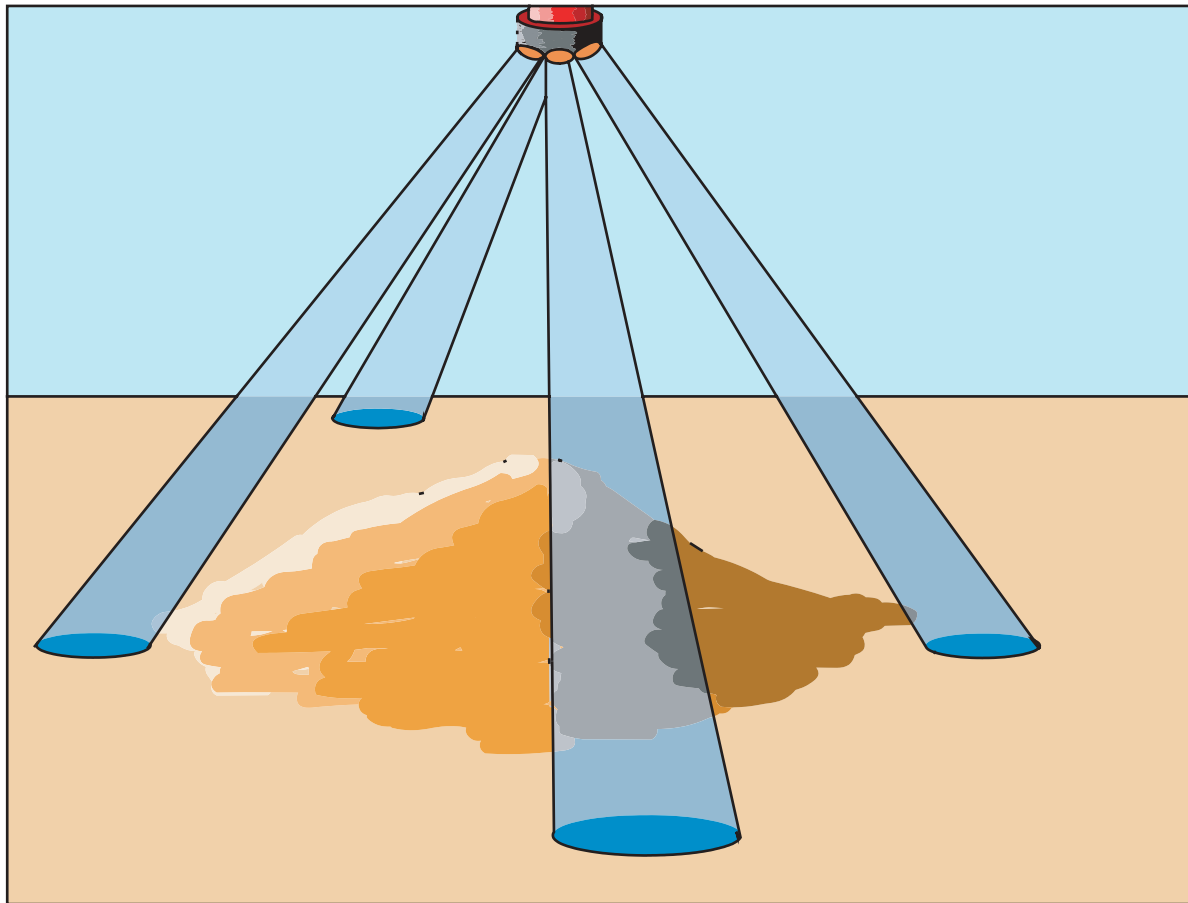

**Figure 9.11.** Exaggerated instance of depth error due to limitations of the acoustic beams.

errors have been covered in previous chapters, but are summarized here.

#### **Incorrect Transducer Draft**

This error probably is the most common operator-caused bias error. Missetting the transducer draft can cause significant discharge-measurement errors, particularly in wide, shallow channels.

#### **Improper Broad-Band Acoustic Doppler Current Profiler Mounting**

If the BB-ADCP is mounted to the side of the boat keel and in the boat wake, entrained air can cause occlusion of one or more BB-ADCP beams. A BB-ADCP that is mounted too high near the boat hull can suffer from the “good side/bad side” effect. The “good side/bad side” effect manifests itself in a series of discharge measurements that seem to be directionally biased. For example, discharges measured from right to left bank seem to be significantly different from discharges measured from left to right bank. Victor Levesque (U.S. Geological Survey, oral commun., 1996) has quantified this error and has

associated it with the venturi effect of the boat hull on flowing water: water passing under the boat hull is slowed on the streamward side of the boat, and accelerated on the downstream side of the boat. This effect causes bias in the uppermost bins. Averaging even numbers of transects can help reduce this error.

#### **Incorrect Edge-Distance Estimates**

Distances to the riverbank are almost always underestimated unless the operator is very close to the riverbank when the distance is estimated. This underestimation can cause a significant bias error, if undetected.

#### **Incorrect Estimated Edge Shapes**

In narrow channels, significant bias errors can result from incorrectly characterizing the near-bank geometry. Rectangular-shaped edge-discharge areas can contain significant amounts of unmeasured discharge if the triangular edge algorithm is used for edge-discharge estimation.

### Bottom Movement

As a general rule of thumb, all discharge measurement series taken where velocities are greater than 1 ft/s or where bottom movement is suspected should be followed or preceded by a bottom movement check (chap. 8).

### Configuration-File Error

Every BB-ADCP operator undoubtedly has collected transects with the wrong configuration file or has inserted incorrect direct commands in the configuration file (at least once). Attention to detail will help eliminate this error.

### Poor Choice of Cross Sections

Because the BB-ADCP is such a versatile instrument, it is easy to measure discharge in a cross section that normally would be rejected for use with conventional methods. “Pan-handle”-shaped cross sections with deep channels near one side of the river are examples of poor cross sections. The beam “footprint” (with accompanying side lobes) becomes larger as depths increase. Discharge in a submerged canyon may be unmeasurable because the beams and side lobes impinge the canyon walls. Proper reconnaissance and experience will help in choosing a cross section that eliminates bias problems due to this effect.

### Common Sense Rules

By following the common sense rules listed below, errors in discharge measurements can be reduced or eliminated:

- Be a smooth operator! The BB-ADCP discharge-measurement system will give more consistent results if rapid movements and course changes are kept to a minimum. Smooth boat motion is more important than a straight-line course
- Be observant! Are the edge flows moving in the same direction as the main body of flow? Did

the wind come up? Did a motorboat pass the bow of the measurement vessel during the transect? This information may be needed during playback to properly evaluate the discharge measurement

- Is the discharge-measurement vessel moving slowly enough? The more pings collected during a discharge measurement, the more precise the measurement
- Examine discharge data on site, if possible. Problems with improper setup may not appear until the measurements are replayed
- Don't trust an “eyeball” edge estimate. Most people tend to underestimate the distance to shore unless the vessel is very close to shore when the estimation is attempted
- Don't be afraid to ask for help! Experienced BB-ADCP operators carry a cellular phone, a long list of phone numbers, and are not afraid to ask, “What gives here?” Only novice operators are too proud to ask for help.

## Summary

If high sediment loads are not present, errors in acoustic Doppler current profiler (ADCP) discharge measurements usually are caused by traversing the river too fast during the discharge measurement. As a rule, the vessel should traverse the river at the approximate speed of the mean water velocity to obtain consistently precise discharge measurements. When measuring wide, deep rivers or estuaries, the operator should use equation 9.1 to estimate correct vessel traverse rates, if possible. If the operator checks the standard deviation of the discharge measurements at the measurement site he or she can easily determine if the discharge measurements have too much scatter (5 percent or greater). If such is the case, the boat traverse rate can be slowed and the measurements can be redone. Most bias errors can be eliminated with proper attention to detail.

## REFERENCES CITED

- Buchanan, T.J., and Somers, W.P., 1969, Discharge measurements at gaging stations: Techniques of water resources investigations of the United States Geological Survey, book 3, chap. A8, 68 p.
- Chen, Cheng-Lung, 1989, Power law of flow resistance in open channels. Manning's formula revisited: International Conference on Channel Flow and Catchment Runoff. Centennial of Manning's Formula and Kuichling's Rational Formula, May 22–26, 1989, Charlottesville, Virginia, (Proc.), v. 8, p. 17–48.
- Chereskin, T.K., Firing, Eric, and Gast, J.A., 1989, On identifying and screening filter skew and noise bias in acoustic Doppler current profiler instruments: Journal of atmospheric and Oceanic Technology, v. 6, p. 1040–1054.
- Christensen, J.L., and Herrick, L.E., 1982, Mississippi River Test, Volume 1. Final report DCP4400/300, prepared for the U.S. Geological Survey by AMETEK/Straza Division, El Cajon, California, under contract No. 14–08–001–19003, p. A5–A10.
- Doppler, J.C., 1842, Über das farbige Licht der Doppelsterne und einiger anderer Gestirne des Himmels: Abn.königl.böhm.Ges.Wiss, v. 2, p. 465–482.
- Fulford, J.M., and Sauer, V.B., 1986, Comparison of velocity interpolation methods for computing open-channel discharge in S.Y. Subitsky (ed.) Selected papers in the hydrologic sciences: U.S. Geological Survey Water-Supply Paper 2290, 154 p.
- Hansen, S.D., 1986, Design and calibration issues for current profiling systems. High-frequency volumetric backscattering in an oceanic environment: IEEE Third Working Conference on Current Measurement, January 22–24, 1986, Airlie, Virginia, (Proc.), p. 191–202.
- Lipscomb, S.W., 1995, Quality assurance plan for discharge measurements using broad band acoustic Doppler current profilers: U.S. Geological Survey Open-File Report 95–701, 7 p.
- Matalas, N.C., and Langbein, W.B., 1962, Information content of the mean: Journal of Geophysical Research, v. 67, no. 9, p. 3,441–3,448.
- Morlock, S.E., 1996, Evaluation of acoustic Doppler current profiler measurements of river discharge: U.S. Geological Survey Water-Resources Investigations Report 95-4218, 37 p.
- Minkoff, John, 1992, Signals, noise, and active sensors. Radar, sonar, laser radar: John Wiley and Sons, Inc., New York, 249 p.
- Oberg, K.A., U.S. Geological Survey acoustic Doppler current profiler Office of Surface Water support pages. <http://il.water.usgs.gov/adcp>. Accessed July 1998.
- Oberg, K.A., and Schmidt, A.R., 1994, Measurements of leakage from Lake Michigan through three structures near Chicago, Illinois, April–October 1993: U.S. Geological Survey Water-Resources Investigations Report 94-4112, 48 p.
- R.D. Instruments, Inc., 1989, Acoustic Doppler current profilers—Principles of operation. A practical primer: R.D. Instruments, San Diego, California, 36 p.
- , 1994, Users manual for R.D. Instruments' Transect Program for use with broadband acoustic current profilers: R.D. Instruments, Inc., San Diego, California, 190 p.
- , 1995, Direct reading and self contained broadband acoustic Doppler current profiler technical manual for Firmware version 5.XX: R.D. Instruments, Inc., San Diego, California, 460 p.
- , 1996, Principals of operation. A practical primer for broadband acoustic Doppler current profilers (2nd ed.): R.D. Instruments, Inc., San Diego, California, 51 p.
- , 1999, Workhorse Rio Grande technical manual. P/N 957-6101-00. <http://www.rdinstruments.com>. Accessed February 2000.
- Simpson, M.R., and Oltmann, R.N., 1993, Discharge measurement using an acoustic Doppler current profiler: U.S. Geological Survey Water-Supply Paper 2395, 34 p.
- Theriault, D.B., 1986, Incoherent multibeam Doppler current profiler performance: IEEE Journal of Oceanic Engineering, v. 11, no. 1, p. 7–25.
- Urick, R.J., 1975, Principles of underwater sound. (2nd ed.): McGraw-Hill, San Francisco, California, 375 p.