

Characteristics of Pulsatile Flow with the Same Oscillatory Fraction in a Grooved Channel

Xiaoyu ZHANG^{*1}, Hirofumi ARIMA^{*2}, Yongning BIAN^{*1} and Yasuyuki IKEGAMI^{*2}

^{*1}State Key Laboratory of Structural Analysis for Industrial Equipment
Dalian University of Technology, 116024, China

^{*2}Institute of Ocean Energy, Saga University, 840-8502, Japan

Abstract

The flow characteristics with the same oscillatory fraction in the grooved channel for pulsatile flow have been conducted experimentally. The results showed that for the same oscillatory fraction, the pressure drop decreases monotonously with the frequency of the pulsatile flow in the laminar flow and transitional flow, while it has an inflection point and then increases in the turbulent flow. On the other hand, the local pressure has few changes with the overall pressure drop in laminar and turbulent flow, but it behaves randomly in the transitional flow. The above results are very important for the design of the efficient heat exchanger.

Keywords : Grooved channel, Pulsatile flow, Oscillatory fraction, Local pressure, Overall pressure drop

1. Introduction

Humans entered into the 21st century, along with the development of modern society, people meeting more and more serious energy problems. Ocean thermal energy conversion (OTEC) is a useful way to solve the energy crisis that uses the different temperatures between warm seawater and cold seawater to produce electricity^[1]. As a most important apparatus of the OTEC system, it is indispensable to improve the heat and mass transfer efficiency of the plate type heat exchanger. Many investigators devote their efforts to this requirement.

Initially, Bellhouse et al.^[2] studied how large fluid oscillations improve fluid mixing and mass transfer in a 2-D furrowed channel. They confirmed that the combination of a large laminar oscillation with a much smaller mean flow through a wavy-walled channel could achieve a higher mass transfer rates. Nishimura et al.^[3] conducted an experiment about the flow characteristics in wavy-walled channels for steady flow. They got the critical Reynolds numbers which is 350 for the way channel and claimed that the unsteady vortex motion significantly promotes wall shear stress at the maximum cross section. Then Nishimura et al.^[4] finished another study on mass transfer characteristics for pulsatile flow. They found that the mass transfer enhancement depends on three parameters: net flow Reynolds number, oscillatory fraction of the flow rate, and Strouhal number. Meanwhile, Brevard Garrison and Chris Rogers^[5] found that oscillations of the shear-layer and Ekman-layer pumping are the dominant mechanism for fluid transfer in most cases. Furthermore, B.S. Lee et al.^[6] discussed the mass transfer enhancement in an axisymmetric wavy channel for pulsatile laminar flow. Their numerical results indicated that the optimal Strouhal number increases as the Reynolds number and the channel wavelength decreasing. Later, Nishimura et al.^[7] described the fluid flow and mass transfer with a wavy-walled tube at moderate Reynolds numbers. Sun et al.^[8] researched the Strength characteristics of the self-sustained wave in grooved channels with different groove length. They found the first and second frequency of the T-S wave. At the same time, they reported that they will get a higher amplitude of the T-S wave by increasing the pressure, which is of great help to the more efficiency exchangers for OTEC.

In this study, the available pulsatile operating range and oscillatory fraction range for the experimental apparatus will be decided. And then, the overall pressure drop and local pressure will be examined and the flow characteristics will be discussed systematically.

2. Experimental Apparatus

The experiment is carried out with the apparatus shown in Fig.1. The flow is provided by a centrifugal pump and the city water is used as the working fluid. The steady flow rate Q_s is controlled by the control valve and the amplitude Q_0 of the pulsatile flow is adjusted by the piston pump, both of them are measured with an electromagnetic flowmeter.

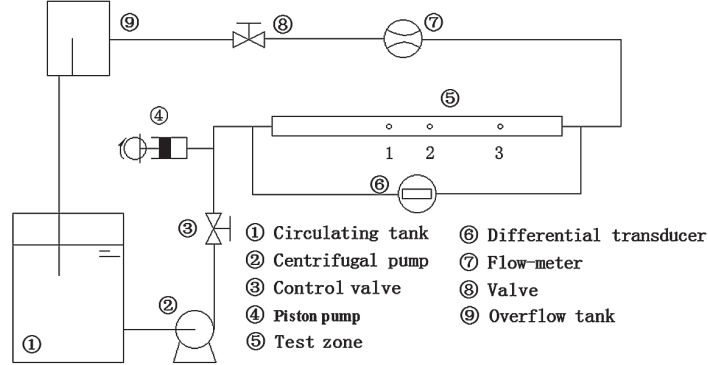

Fig.1 Diagram of the experimental system

The test section is shown in Fig.2 which is consisted of two plates, and its dimension is $L=20\text{mm}$, $W=200\text{mm}$, $h=2.5\text{mm}$ and $l=12\text{mm}$. The overall pressure drop of the test section ΔP is recorded by a differential transducer.

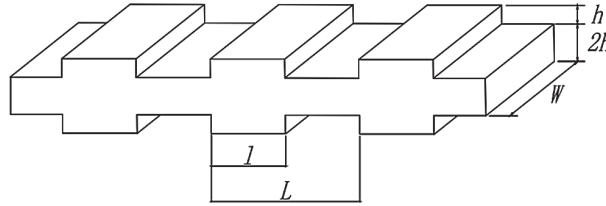

Fig.2 Dimension of the grooved channels

The local pressures (P_1 , P_2 and P_3) are measured by the pressure sensors. Only three different sites shown in Fig.3 are used to measure the local pressures because of the effect of the entrance length. The distance between the points is $d_1=210\text{mm}$ and $d_2=420\text{mm}$.

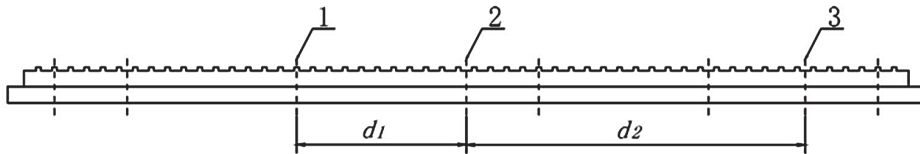

Fig.3 Points of the measurement

The Reynolds number Re , the amplitude of the pulsatile flow Q_0 and the oscillatory fraction P are calculated according to the following definitions:

$$Re = \rho * u * h / \mu \quad (1)$$

$$Q_0 = 0.5\pi^2 * f * s * D^2 \quad (2)$$

$$P = Q_0 / Q_s \quad (3)$$

Where, ρ is the density of water, $u = 1.5u_m$ is the characteristic flow velocity and $u_m = Q / (2Wh)$, while μ is the viscosity of water which is $0.001 \text{ Pa}\cdot\text{s}$ in the experiment and f is the frequency of the pulsatile flow. S is stroke of the piston pump. $D = 50\text{mm}$, is the diameter of the piston pump in the piston pump. All the experiments are conducted under the room temperature.

3. Results and Discussion

3.1 Validation of the experimental method

The pulsatile flow for the experiments is conducted by the piston pump which is droved by a servo motor. There is

a metal plate with some holes connecting the pump and the motor, and the stroke of the piston pump can be controlled by changing the holes attached to the motor. On account of the limitation of the apparatus, some tests have been done and the available operating range is decided, that s ranges from 20mm to 70mm and P ranges from 0.3 to 1.0.

The purpose of the experiment is to test the characteristics with the same P , but according to the instability of electromagnetic flowmeter and centrifugal pump, some exams had been done to verify the experimental method. After measured the overall pressure drop and the local pressure in the grooved channel with $Q_s=140\text{ml/s}$ for all available s and f , some calculations have been done for the relationship of P and f , and the contrast results of the calculations and the experiments are shown in Fig.4.

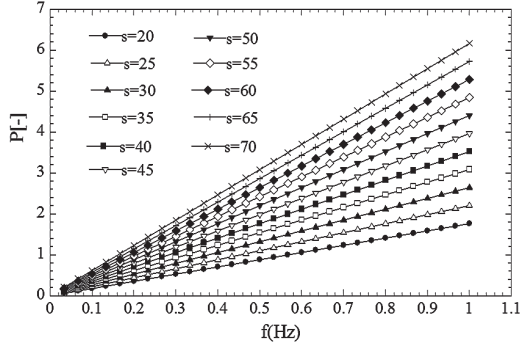

Fig.4 (a) Oscillatory fractions in calculation

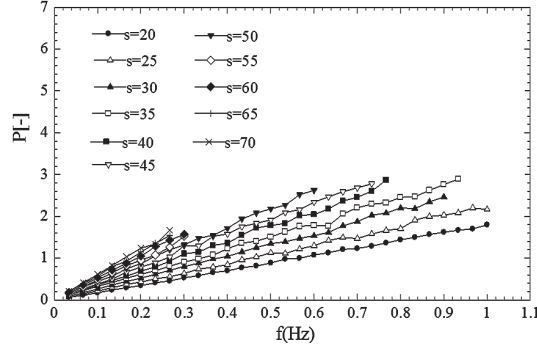

Fig.4 (b) Oscillatory fractions in experiment

The patterns are similar for each other and some data of $s=20\text{mm}$ are picked out for understanding directly as shown in Fig.5. The oscillatory fractions increase in the same slope between the experiment and calculation, and the data are almost same for each other below the line $P=1$. The same graphs can be got in other conditions, so the method is practicable for the experiment.

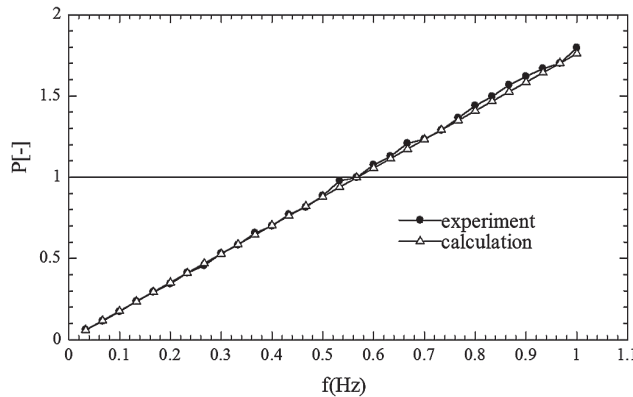

Fig.5 $P - f$ in $s = 20\text{mm}$

3.2 Filter processing

To investigate the characteristics with the same P , frequency of the pulsatile flow for every stroke should be calculated, the frequency with $Q_s=140\text{ml/s}$ for $P=0.5, 0.7$ are shown in table 1.

Table 1 Frequency of pulsatile flow with $Q_s = 140\text{ml/s}$ for $P = 0.5, 0.75$

s (m)		0.020	0.025	0.030	0.035	0.040	0.045	0.050	0.055	0.060	0.065	0.070
f (Hz)	$P = 0.5$	0.284	0.227	0.189	0.162	0.142	0.126	0.114	0.103	0.095	0.087	0.081
	$P = 0.75$	0.426	0.341	0.284	0.243	0.213	0.189	0.170	0.155	0.142	0.131	0.122

Then some studies have been done taking advantage of the result of calculation, the results are captured for various strokes at different status which are measured by Sun et al. [8], that the fluid is in laminar flow when the Reynolds number is less than 265 and the flow rate is less than 71ml/s , and it is in turbulent flow when the $Re > 601$ and the $Q > 160\text{ml/s}$, then it is transitional flow while the two parameters are at intermediate values. All the experimental data are processed with a low-pass filter.

The filter is a linear low-pass FIR filter which is designed by FDA tool. In order to save time in the course of the

experiment, various sample frequencies have been set and then many filters have been designed. Now, taking the sample frequency of 100 Hz for example, frequencies of passband boundary and stop band boundary are 1 Hz and 2 Hz, respectively. Passband ripple is less than 0.1 dB in the frequency band less than 1 Hz and stopband attenuation is greater than 80 dB in the frequency band more than 2 Hz. Then, data that are measured in $Q_s = 140\text{ml/s}$, oscillatory fraction $P = 1.0$, $s = 20\text{mm}$ were processed and the result is shown in Fig.6. It is seen that high-frequency signal cannot through the filter and the curve is smoother, and then the measured data are more accurate and credible.

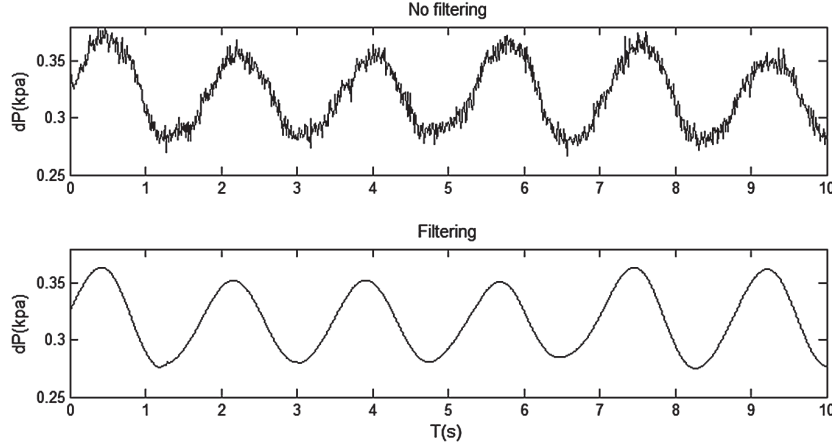

Fig.6 Contrast with the data on no filtering and filtering

3.3 Flow characteristics for different frequencies with the same oscillatory fraction

To understand the characteristics of pulsatile flow with the same oscillatory fraction, the behaviors of the overall pressure drop and the local pressure have been researched. The oscillatory fractions range from 0.2 to 1 due to the limitation of the experiment apparatus, and the experiment is divided into three parts: laminar flow, transitional flow and turbulent flow, and the flow characteristics will be discussed respectively.

(1). Characteristics in laminar flow

To investigate the flow characteristics in laminar flow, the study of $Q_s = 60\text{ml/s}$ for the same oscillatory fraction has been done. The experimental results indicate that the numbers of ΔP reduce as the frequency increasing persistently as shown in Fig.7 (a). The fluctuations of the curves are ascribed to the instability of apparatus.

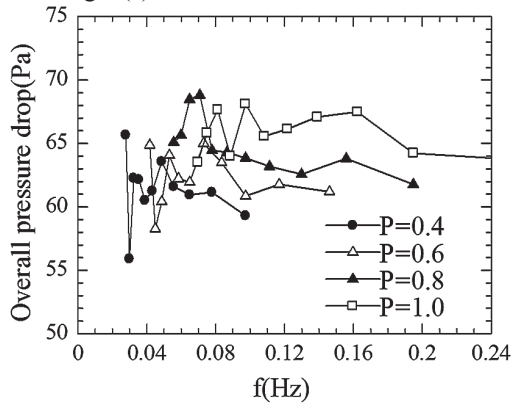

Fig. 7(a) ΔP - f in $Q_s = 60\text{ml/s}$

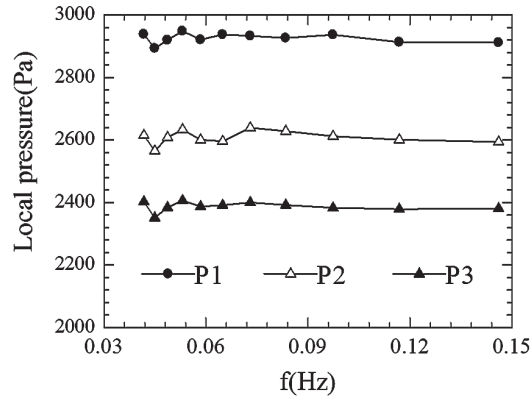

Fig. 7(b) $P1, P2, P3$ - f in $P = 0.6$

Furthermore, the specialty of local pressure for $P = 0.6$ is shown in Fig. 7(b), and the diagram shows that the $P1, P2, P3$ have the same characteristics with each other and they also have the same behaviors with the overall pressure drop, that they decrease with the increment of the oscillation frequency. The same phenomena can be observed in other oscillatory fractions.

(2). Characteristics in transitional flow

In this part, two experiments have been done in $Q_s = 100\text{ml/s}$ and $Q_s = 140\text{ml/s}$, and the same conclusion can be got with the study in $Q_s = 60\text{ml/s}$ for the overall pressure drop, that the ΔP has an opposite trend with the oscillation frequency.

But, the characteristics of local pressure with the frequency are quite different, even though the $P1$, $P2$, $P3$ still have the same characteristics with each other on any terms. Fig.8 gives some graphs of $P1$ in different conditions.

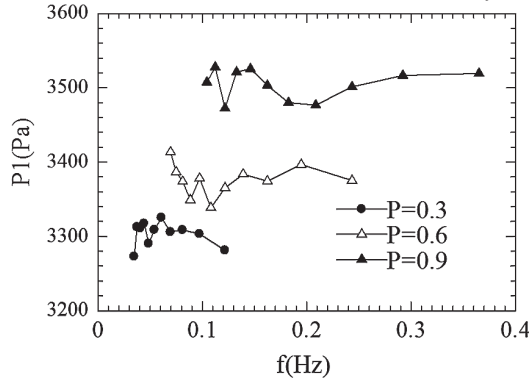

Fig.8 (a) $P1-f$ in $Q_s= 100\text{ml/s}$

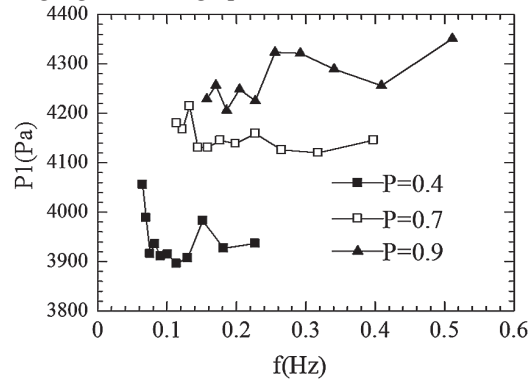

Fig. 8(b) $P1-f$ in $Q_s= 140\text{ml/s}$

In this section, the local pressure behaves irregularly, it increases with the increment of the frequency some times, and reduce itself other times. Even thinking about the influence of apparatus, the irregularity of the local pressure is still obvious and incomprehensible. Therefore, the local pressure behaves randomly for transitional flow in grooved channels.

(3). Characteristics in turbulent flow

To examine the relationship between the flow characteristics and the frequency in turbulent flow, a research has been done in $Q_s= 200\text{ml/s}$. A similar phenomenon for the overall pressure drop can be found in the $P=0.2\sim 0.6$ part just as what it does in laminar and transitional flow, the ΔP decreases monotonously with the increment of the f .

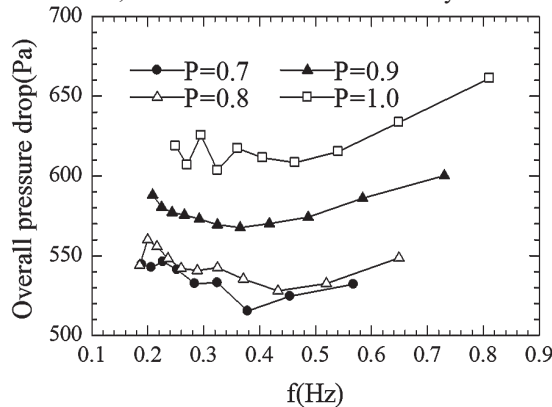

Fig.9 $\Delta P-f$ in $Q_s= 200\text{ml/s}$

However, in the section that P is equal or greater than 0.7, the behaviors of the overall pressure drop, as shown in Fig 9, become quite different from what observed before. It is seen in these figures that at the beginning, the ΔP decreases with the increment of the frequency as usual, then it begins increasing when the f rises to about 0.5. Table 2 lists some numbers of the inflection points and it is very hard to find any regularity for the inflection frequency from the table. Whereas, if takes the effect of the flow rate fluctuation into consideration, the table can be amended by adding some feasible turning points and the rules are apparent. Therefore, the results indicate that the inflection frequency increases with the increment of the oscillatory fraction.

Table 2 Values of inflection frequency

Oscillatory fraction	$P=0.7$	$P=0.8$	$P=0.9$	$P=1.0$
Inflection frequency	0.3786	0.4327	0.3651	0.4637
Inflection frequency (amended)	0.3246	0.3709	0.3651	0.4057
	0.3786	0.4327	0.4173	0.4637

Moreover, the local pressure has the same trend just as what the overall pressure drop does in turbulent flow, that it behaves randomly as it is in the transitional flow for small oscillatory fraction, and when the P is equal or greater than

0.7, it decreases with the increment of the frequency as usual, then it begins growing its values when the f rises to about 0.4.

4. Conclusions

The characteristics of pulsatile flow with the same oscillatory fraction in grooved channel are described. By discussing the behaviors of the overall pressure drop and the local pressure, the main remarks are drawn as follows:

(1) For the same oscillatory fraction, the characteristics of the overall pressure drop are quite different from each other in various flow regions. In the laminar and the transitional flow, the ΔP reduces as the frequency increasing persistently, and in the turbulent flow it behaves as usual for the low oscillatory fraction. However, as the P meeting or exceeding 0.7, the ΔP decreases with the increment of the frequency at the beginning, then it increases its values when the f rises to about 0.4, meanwhile the yielding frequency increases with the increment of the oscillatory fraction.

(2) The local pressures behave all the same with each other for any conditions. In the section of the same oscillatory fraction, it has an opposite trend with the oscillation frequency in the laminar flow, and the local pressure behaves irregularly in the transitional flow. In the turbulent flow, the local pressure behaves unpredictable as it is in the transitional flow for low oscillatory fraction, and in the high ones, it decreases with the increment of the frequency when beginning, and then it starts to grow as the frequency are added after an inflection point.

Acknowledgements This study is sponsored by the Cooperative Research Program of IOES (No.15005A) and the Natural Science Foundation of China (No. 11172059).

References

- [1] Lennard DE, The viability and best locations for ocean thermal energy conversion systems around the world, *Renewable Energy*, Vol.6, (1995), pp.359-365.
- [2] Bellhouse, B.J., Bellhouse, F.H., Curl, C.M., Macmillan, T.I., Gunning, A.J., Spratt, E.H., MacMurray, S.B. and Nelems, J.M., A high efficiency membrane oxygenator and pulsatile pumping system and its application to animal trials. *Trans. Amer. Soc. Artif. Int. Organs.*, Vol.19, (1973), pp.72-79.
- [3] Nishimura, T., Ohori, Y., and Kawamura, Y., Flow characteristics in a channel with symmetric wavy wall for steady flow, *J Chem Eng Japan*, Vol.17, (1984), pp. 466-471.
- [4] Nishimura, T. and Kojima, N. , Mass transfer enhancement in a symmetric sinusoidal wavy-walled channel for pulsatile flow, *Int. J. Heat Mass Transfer*, Vol. 38, (1995), pp. 1719-1731.
- [5] Brevard Garrison and Chris Rogers, An experimental study of enhanced fluid transfer mechanisms between a channel and a cavity, *Phys. Fluids*, Vol. 6, (1994), pp. 421-423.
- [6] B.S. Lee, I.S. Kang, H.C. Lim, Chaotic mixing and mass transfer enhancement by pulsatile laminar flow in an axisymmetric wavy channel, *International Journal of Heat and Mass Transfer* 42 (1999) 2571-2581.
- [7] Nishimura T, Bian Y.N., Kunitsugu K and Morega A.M, Fluid flow and mass transfer in a sinusoidal wavy-walled tube at moderate Reynold numbers, *Heat Transfer—Asian Research*, Vol. 7, (2003), pp. 650-661.
- [8] Sun F.M., Bian Y.N., Arima H., Ikegami, Y. and Xu X.S., Strength characteristics of the self-sustained wave in grooved channels with different groove length, *Heat and Mass Transfer*, Vol. 46, (2010), pp. 1229-1237.