

## Article

# A Preliminary Study on Identifying Biomimetic Entities for Generating Novel Wave Energy Converters

Hui Zhang <sup>1</sup>, Wanan Sheng <sup>2</sup>, Zhimin Zha <sup>1</sup> and George Aggidis <sup>2,\*</sup>

<sup>1</sup> Marine Engineering Equipment College, Zhejiang Ocean University, Zhoushan 316022, China; zhanghui@zjou.edu.cn (H.Z.); zhazhimin96@126.com (Z.Z.)

<sup>2</sup> Renewable Energy and Fluid Machinery Group, Engineering Department, Lancaster University, Lancaster LA1 4YW, UK; w.sheng@lancaster.ac.uk

\* Correspondence: g.aggidis@lancaster.ac.uk; Tel.: +44-15-2459-3052

**Abstract:** Biomimetics and creatures could contribute to novel design inspiration for wave energy converters, as we have seen numerous examples in applications of other branches of engineering. However, the issue of how to obtain valuable biological entities, or bionic design cases, that could produce inspiration for novel designs, may be challenging for the designers of wave energy converters (WECs). This study carries out preliminary research on the acquisition of biological entities for designers, to obtain innovative bio-inspired ideas for designing novel WECs. In the proposed method, the first step is to draw out engineering terminologies based on the function, structure, and energy extraction principles of existing WECs. Then, by applying WordNet, candidate biological terminologies can be obtained. Next, using AskNature, along with manual selection and filtering, biological terminologies can be acquired. The last step is to use the biological terminologies to establish the reference biological entities, and to use the information and knowledge of these entities in the design of an innovative WEC. Using the proposed methodology, a novel WEC was conceived and verified.

**Keywords:** design inspiration; biological entities; innovative designs; wave energy converters



**Citation:** Zhang, H.; Sheng, W.; Zha, Z.; Aggidis, G. A Preliminary Study on Identifying Biomimetic Entities for Generating Novel Wave Energy Converters. *Energies* **2022**, *15*, 2485. <https://doi.org/10.3390/en15072485>

Academic Editor: Eugen Rusu

Received: 24 February 2022

Accepted: 22 March 2022

Published: 28 March 2022

**Publisher's Note:** MDPI stays neutral with regard to jurisdictional claims in published maps and institutional affiliations.



**Copyright:** © 2022 by the authors. Licensee MDPI, Basel, Switzerland. This article is an open access article distributed under the terms and conditions of the Creative Commons Attribution (CC BY) license (<https://creativecommons.org/licenses/by/4.0/>).

## 1. Introduction

Wave energy is a clean and sustainable energy source with huge potential to provide a continuous energy supply to the energy mix. To make use of abundant ocean energy, WECs are essential devices, as they can extract the energy contained in waves and convert it into useful energy and electricity. In order to convert ocean energy effectively, efficient wave energy converters must be developed. In principle, wave energy converters can use different motions of the WEC—for instance, surge, heave, and pitch motions—as well as different energy conversion principles, such as point absorbers, attenuators, oscillating wave surge converters, overtopping, oscillating water columns, bulge waves, etc. In deployment, different types of WECs may be deployed on the shoreline, nearshore, or offshore, and can be on the surface, in the water, or on the seabed, so to better extract the wave energy at different depths and different locations. Currently, WECs have many disadvantages, such as high cost of energy production, low energy conversion efficiency, low survivability and reliability, and so on. Therefore, it is very desirable to design innovative wave energy converters, or improve existing WECs, to overcome all or some of the aforementioned disadvantages.

At same time, due to the nature of ocean waves, wave energy generation generally takes place under large forces and at low frequencies/speeds, which creates challenges for efficient and reliable wave energy production; wave energy extraction becomes even more challenging during extreme weather conditions, in which waves can generate significantly larger forces and cause significant damage to the wave energy converters.

In order to overcome the difficulties of wave energy generation, and to improve the performance of WECs, a large number of researchers have conducted extensive research on different aspects of WEC devices, including the hydrodynamic performance of the WECs [1–3], Power Take Off (PTO) optimization [4–6], the control of wave energy conversion [7], and so on. At the same time, developers have applied some characteristics of biology to WEC design, to improve the performance and survivability of WECs [8] as bio-WECs.





A bio-WEC refers to a biology-inspired wave energy converter. That is, the bio-WEC was designed with biological inspiration triggered by information about the function, shape, motion, behavior, strategies, and other features of biological entities. Generally, a bio-WEC would have one or more features adopted from the biological entities. Good examples include: the Oyster [9], that swings back and forth similar to the opening and closing shells of an oyster; the Pelamis WEC [10], inspired by the shape and motion of sea snakes; the Wave Dragon [11], which is inspired by the shape of a dragon's wings; the Anaconda WEC [12], which simulates the swallowing behavior of Anacondas, and more.

Generally, existing bio-WECs (here a bio-WEC refers to a WEC with one or more biological features) have a good survivability [13]; however, they also have disadvantages, including Low cost-effectiveness [14], low stability [8], low conversion efficiency [11], and high cost of energy production [15] (see Table 1). Although bio-WECs are not perfect, receiving inspiration from nature and from creatures could still provide the inspiration to design innovative and practical WECs, similar to many other branches of engineering problems [16–18]. The use of biological knowledge, including biological attributes, biological functions or behaviors, biological principles, and biological wisdom, could inspire designers to design products that meet performance requirements; i.e., achieve goals of efficient and reliable energy production [19]. Thus, there is an increasing number of researchers who are investigating the relevant problems [20].

The methods of using biological knowledge to design innovative products can be divided into three different types, according to the design level [21]. The first method is to copy the biological attributes. This is the most widely used and direct method, for which a only short time is taken to complete the innovative design of a product, but which requires advanced modelling techniques. The second method is to artificially simulate the biological functions, in which it is necessary to explore the behavioral representation model and function. The third approach is to develop a product based on a biological prototype, which could be used for more complex design requirements. The biological working principles and intelligence could be used to optimize and improve the engineering design. Regardless of which method is used, there is always a need to first find the ideal biological entities, then to use their properties, functions, principles, or wisdom to construct novel solutions, and finally to use them in the innovative design of WECs. Therefore, obtaining suitable biological entities in order to assist WEC innovation is very desirable. This research presents a systematic methodology for identification of ideal biomimetic entities which can be used to assist the generation of novel WECs.

In this paper, the rest of the contents is arranged as follows: The current methodologies for establishing ideal biomimetic entities for innovative designs are summarized in Section 2. A novel method of finding valuable creatures to assist WECs innovation is proposed in Section 3. In Section 4, the effects of using different engineering features of WECs to retrieve biological entities are described. At the same time, an example of conceiving novel design ideas of WECs was illustrated using TALOS WECs as case studies. The advantages and disadvantages are discussed, using AskNature to filter the candidate biological terminologies, in Section 5. Finally, the features of the proposed method are analyzed. Then, the insights and conclusions are drawn and synthesized.

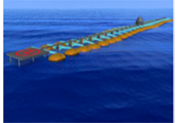
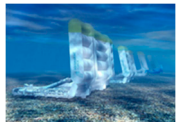
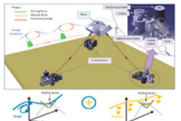
**Table 1.** Features of existing bio-WECs (All pictures are loyalty free).

Bio-WEC Examples	Types of WEC	Mimicked Types	Mimicked Objects	Methods of Power Extraction	Advantages	Disadvantages	Images of Bio-WEC
Pelamis [10]	Attenuator	Shape, Motion	Sea Snake	Pitch, Yaw	High conversion efficiency when the wavelength matches the pitch.	Low adaptability, the pitch is fixed, and cannot adjust to sea conditions.	
Wave Dragon [11]	Overtopping/Terminator	Shape	Dragon	Overtopping	High flexibility, freely up-scale, and adjust to varying wave heights.	Low conversion efficiency; optimization of the power production is required.	
BioWAVE [13]	Oscillating Wave Surge Converter	Function, Motion	Kelp	Surge	High survivability, protected on the seabed during storm conditions.	Low adaptability; appropriate water depths required to be selected.	
Centipod [14]	Attenuator	Structure	Centipod	Heave	Low environment impact.	Low cost-effectiveness; the loads and stresses on the structure require reduction.	
Oyster [9]	Oscillating Wave Surge Converter	Behavior	Oyster	Surge	High survivability.	Low conversion efficiency; need to form cluster arrays and unit field.	
Sea Heart [8]	Point Absorber	Principle	Human Heart	Heave, Surge	High flexibility; hybridization of marine waves and sea current energy sources.	Low stability; the stability of electrical energy requires solving.	
Anaconda [12]	Bulge Wave	Shape, Principle	Anaconda& Human Heart	Bulge Wave	High cost-effectiveness owing to simple structure and durable material.	Low conversion efficiency; the parameters and the performance require improvement.	

## 2. Current Methodologies

Currently, the retrieved objects mainly include two types. One of the retrieved objects is a bionic design case; that is, a prototype or product that was developed according to the characteristics of a certain creature. For example, the mechanical arm was designed to imitate the nose of an elephant [22]. Next, after obtaining a bionic design case, other features of the bionic object, such as function, shape, structure, and behavior, can be attained. These features can also be used to provide inspiration for the proposal of new applications, such as using the elephant's ear, as an example, to stimulate a design inspiration. Other uses can also be developed based on the existing features of the bionic object. For example, the elephant's nose can spray water in addition to lifting a heavy object, so this water-spray function could inspire another new design idea.

Another type of retrieved object is a biological entity. Usually, we tend to not pay attention to some characteristics of the biological entity. Thus, there are no design cases which are stimulated by such biological entities. Design inspiration can often be obtained by analyzing the function, structure, morphology, and manner of the creature. When the obtained biological entity is used to assist the product design, the special features of the creature make the product more innovative.

Whether a biological entity or a bionic design case, retrieved objects can provide designers with inspiration to create novel solutions. Now, a lack of biological entities and bionic design examples hinders designers' innovative design process. In order to retrieve valuable biological entities and biomimetic design cases, as well as acquire relevant biological knowledge, researchers have carried out a large volume of research, which can be categorized into three commonly used methods.

### (1) Obtaining biological entities and cases using the functional model

Goel et al. [23] used the SBF (Structure-Behavior-Function) model to acquire the functions of biological systems. They developed the DANE (for Design by Analogy to Nature Engine) [24–26] database, which includes design case libraries of biological and engineering systems. The database can be accessed and used for the conceptual design of products. Chakrabarti et al. [27] used the SAPPPhIRE functional model of biological and engineering systems to acquire functions of biological systems, and constructed an IDEAINSPIRE database containing biological systems and engineering systems to support innovative product design. Sartori et al. [28] used function and structure, in the FBS (Function-Behavior-Structure) model, to retrieve examples of biological analogies. The FBS model was provided by Gero [29] to describe the physical phenomena related to the function in the engineering problem.

### (2) Obtaining biological entities and cases using natural language process

Chiu, I. and Shu, L.H., 2007 [30,31], provided some methods to search for biological information in books and papers with the help of natural language processing techniques. These methods use part-of-speech tags, typed-dependency parsing, and syntactic patterns to identify and extract functional keywords. These functional keywords are usually verbs and describe the relevant engineering problems. At the same time, the natural language format can be used to directly retrieve related biological phenomena with the help of a variety of biological information. Cheong, H. et al. [32] used the terms of the Functional Basis [33] and search strategies [33] to search for biological cases in books and papers, to identify words of biological significance.

### (3) Obtaining biological entities and cases using biomimicry taxonomies

This method uses biomimicry taxonomy as a functional keyword to retrieve biological cases. Some biology websites, such as AskNature [34], Biology Online [35], and BIOPS [36] can be used to retrieve biological cases and entities. The AskNature website is an online database with a wealth of biological information that can be used to inspire the design process in a multidisciplinary field. The user can retrieve information according to the desired function, although not all keywords and queries can provide satisfactory results, which depends mainly on the ability of the database to recognize keywords and the amount

of information stored in the database. Biology Online is one of the largest bio-sites, with bio-dictionaries and bioinformatics that provide knowledge about biological phenomena, as well as links to design ideas and applications. Fraunhofer BIOPS is an online tool that assists with the retrieval of biological entities using functional keywords. The number of retrieved results directly relates to the number of available data in these databases.

Stroble, J.K. et al. [37] used a list of collocated verbs in the same sentence as keywords for the retrieval of biological textbooks. Spiliopoulou, E. et al. [38] constructed a functional taxonomy table according to the functional basis and biomimicry institute of the taxonomies. These controlled, functional taxonomies are used to directly search for biological papers to obtain biological entities or biological cases. The search results of these two methods are closely related to the selected data source. As the keywords are selected from a specific database, the amount of data in the database will affect the determination of keywords.

Jahau Lewis Chen and Chang-Lin Lee [39] analyzed the description of the invention principle in TRIZ, according to the required functions to be implemented. They selected verbs with similar meanings to the invention principle as keywords, to retrieve related biological cases from the biological book. The vocabulary in TRIZ is relatively abstract, and the number of inventive principles is limited; thus, not all functions or principles that are needed to find biological objects can obtain corresponding vocabulary in TRIZ.

Following the above analysis, a search is carried out using mainly books, papers, and notebooks, as well as online and other professional databases. There are a few studies directly searching related biological cases and entities in the public domain. In the selection of engineering keywords, most methods use the function of the design object as a keyword, while fewer involve other attributes of the design object, such as structure and motion mode. In addition, many methods use some special database or principle library to obtain keywords, which limits the number of keywords obtained. Therefore, there is a need to explore a method to obtain more valuable biological entities.

### 3. Novel Methodology

According to the above analysis, this paper proposes a method for obtaining an ideal biological entity using the specific steps shown in Figure 1. In the following sub-sections relevant information is provided for each step.

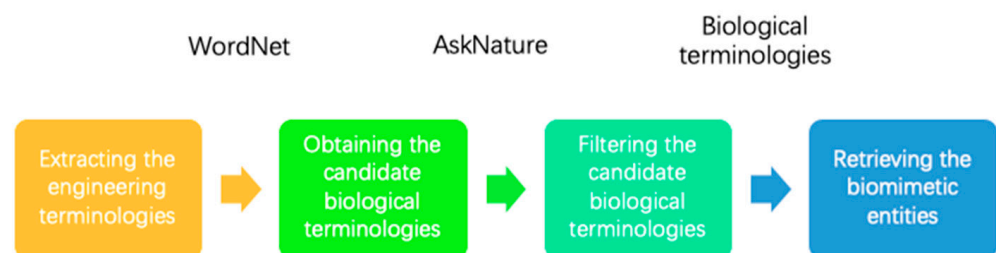

**Figure 1.** Flow chart of the proposed method.

#### 3.1. Extracting Useful Engineering Terminologies

When designing a WEC, it is typical to consider the functions of the WEC, including the system composition, the method of energy extraction, and the related movement behaviors, among other more specific functions. Therefore, useful engineering terminologies may be established for these aspects.

##### 3.1.1. Functions of WECs

The wave energy converter is a device that can convert the energy produced by capturing or extracting wave energy into useful mechanical energy, used for electricity generation, by employing different methods. These methods include the production of air or liquid flow to drive a turbine, the use of high-pressure liquid in a hydraulic motor to drive a generator, and directly driving a generator to generate electricity. Regardless of which method is employed in a WEC, most devices contain some similar functions, and the

relevant terminologies related to the functions are as follows: capturing energy, extracting energy, absorbing energy, and storing energy.

### 3.1.2. Structure of WECs

According to the analysis by Salter S. H. [40], the wave devices employed to produce electricity are usually composed of the following subsystems: (1) elements that interact with the waves and transmit the required forces, (2) means of increasing velocity, rectifying direction, and/or moving in the opposite direction, (3) parts that drive an electrical machine, and (4) connections for combining and transmitting the power to shore. Therefore, the abstract terminologies of the structure of a WEC can be obtained, and include: displacing element, linkage element, adjusting means, rotating part, reaction means, and transforming means.

### 3.1.3. Methods of Power Extraction of WECs

Power extraction of WECs from waves is a key problem in designing a wave energy device. The different devices may use different motion modes for extracting wave energy. For different WECs, the terminologies related to the methods for energy extraction mainly include: surge [9], sway [10], heave [15], pitch [40], roll [41], yaw [42], oscillating water column [43], overtopping [11], bulge wave [12], and others.

## 3.2. Obtaining the Candidate Biological Terminologies

From the above analysis of engineering terminologies, it can be seen that the terminologies associated with the structure and energy extraction method of the WEC are terminologies that represent the state of the movement or behavior. Therefore, candidate biological terminologies can be obtained by finding their respective synonyms.

The candidate biological terminologies can be obtained using the lexical dictionary WordNet [44]. WordNet is the large lexical database of English, based on cognitive linguistics designed by researchers at Princeton University. It has the characteristics of a traditional dictionary, as well as a synonym word database, which together make up a “word network” according to the meaning of words. WordNet uses synonym sets (synsets) to list concepts. These synsets are interlinked with the help of conceptual-semantic and lexical relations. The structure of WordNet makes it a useful tool for retrieving biological terminology. In order to obtain more synonym words of extracted engineering terminologies, these engineering terminologies were simplified in this paper, as seen in Table 2.

**Table 2.** Engineering terminologies of WECs.

Types of Terminologies	Simplified Engineering Terminologies
The functions of WECs	Capture, extract, absorb, store.
The structure of WECs	Displace, linkage, adjust, rotate, transform.
	Reaction.
The methods of power extraction of WECs	Surge, sway, heave, roll, pitch, yaw, oscillating, overtopping, bulge, etc.

### 3.3. Filtering the Candidate Biological Terminologies

The terminologies obtained need to be filtered before retrieving biological entities, as some candidate terminologies may not be biological terminologies. The current most commonly used method for filtering biological terminologies is to use biological dictionaries to identify biological terms [45], such as the Oxford American dictionary [46], Henderson’s dictionary of biological terms [47], the Oxford Dictionary of Biology [48], and many others. However, these methods can be very inefficient in filtering candidate biological terminologies, if only the meanings of biological terminologies can be obtained.

In this paper, a combination method is proposed for filtering. First, synonyms obtained using WordNet are selected, with the aim of obtaining valuable animals or plants

which have specific behaviors or working principles. Then, AskNature is used for secondary filtering, and the words displayed for related items are the resulting biological terminologies.

Tables 3–5 show the filtering methods and selected results of the candidate biological terminologies, according to the function of WECs, the structures of the WECs, and the energy extraction method, respectively. These have been retrieved from the AskNature website.

**Table 3.** Filtering of candidate biological terminologies related to the function of WECs.

	Words with Synset (Semantic) Relation	Deleted Words	
		Manual Selecting	Website Filtering
Capture	Trance, catch, captivate, charm, fascinate, entrance.		Enamor, becharm, enamor, beguile, bewitch, enchant.
	Get, catch.		
	Appropriate, seize.		Conquer.
Extract	Pull, pull out, pull up, take out, draw out, evoke, draw out, press out, etc.		
	Extract.	Distill, distil.	
	Express.	Excerpt.	
Absorb	Ingest, take in, take over, suck, suck up, draw, take up.		
	Steep, immerse, engulf, plunge, soak up.		Engross.
Store	Hive away, lay in, put in, stack away, stash away.	Salt away.	

**Table 4.** Filtering of candidate biological terminologies related to the structures of WECs.

	Words with Synset (Semantic) Relation	Deleted Words	
		Manual Selecting	Website Filtering
Displace			Pre-empt.
	Give notice, can, send away, force out, terminate.	Fire, dismiss, give the axe, sack, give the sack.	
	Move.		
Linkage	Gene linkage.		
Adjust	Set, correct, align, aline, line up, conform, adapt.		
Rotate	Revolve, go around, turn out, splay, spread out.		
			Circumvolve.
Reaction	Chemical reaction, response.		
Transform	Transmute.		Transubstantiate.
	Metamorphose.		
	Transform.	Translate.	

**Table 5.** Filtering of candidate biological terminologies related to the energy extraction method of WECs.

	Words with Synset (Semantic Relation)	Deleted Words	
		Manual Selecting	Website Filtering
Surge	Blow up, reflate, soar, soar up, flush, gush, circulate, run off, run down, pour, spill, run out, etc.		
Sway	Shake, swag, move back and forth, swing, waver, flutter, etc.		Nutate.
	Carry.	Persuade.	
Heave	Inflate, blow up, heave up, heft, heft up, pant, puff, gasp, etc.		
Roll	Turnover, roll out, roll up, wrap, flap, revolve, seethe.		
	Roll.	Hustle, pluck.	
	Wander, stray, cast, rove, etc.		Vagabond.
	Rock, shake, swag, totter.		Nutate.
Pitch	Toss, incline, cant, tilt.		
	Move, stretch out, move over, reciprocate, move back and forth, cant over, tilt, waver, linger, turn, etc.		Wrestle, wobble, fidget, dawdle, squinch.
	Pitch.	Peddle, monger, vend, etc.	
	Pitch.	Gear.	
Yaw	Swerve, sheer, veer, peel off, etc.		
	Divert, detour, depart, straggle, etc.		Sidetrack.
Oscillating	Vibrate, waver, dwell on, linger over, etc.		Waffle.
	Swing, waver, weave, etc.		
Over-topping	Overlook, top, ride, lap, focalize, cap, crest, look across, etc.		Overshadow.
Bulge	Pouch, protrude, bulk, change shape, deform, flatten out, twist, distort, bend, stretch out, extend, etc.		

### 3.4. Retrieving the Biomimetic Entities by the Biological Terminologies

When biological terminologies are used to search for biological entities, the keywords are usually phrases containing biological terminologies, to improve the accuracy of the search. These keywords, such as “function-related biological terminologies plus food/prey”, “structure-related biological terminologies plus mode”, and “energy extraction methods-related terminologies plus motion mode”, can be used to retrieve biological entities. By using these keywords, a number of interesting biological entities can be obtained.

- (1) Retrieval by biological terminology related to the function of WECs, as shown in Figure 2.



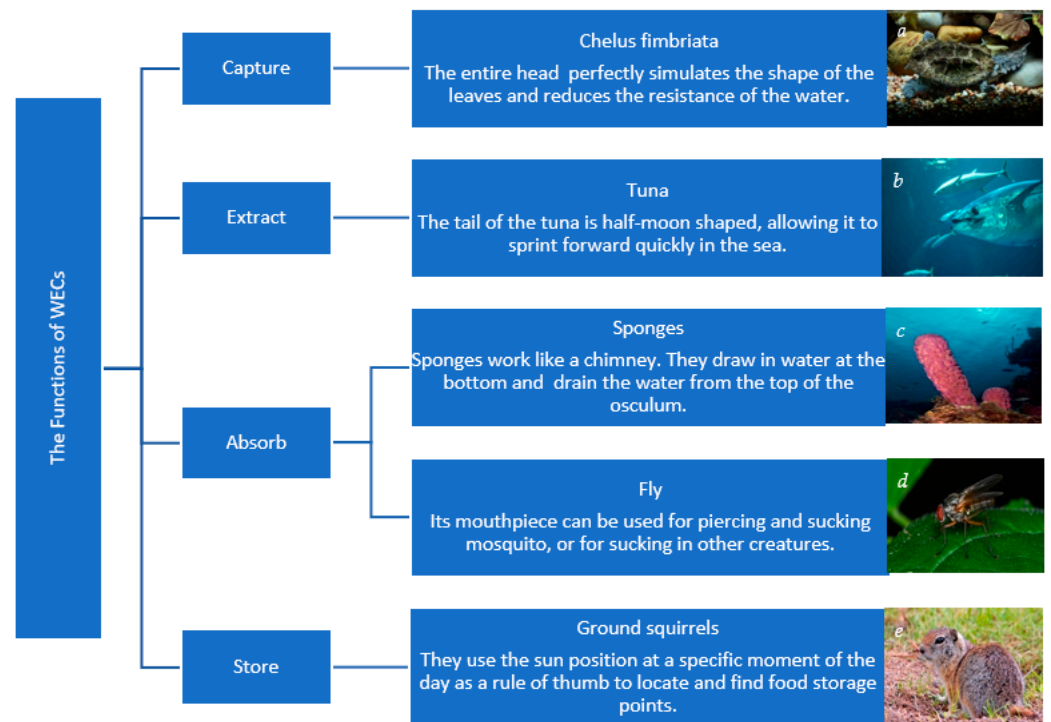

**Figure 2.** Biological entities retrieved by biological terminology related to the function of WECs: (a) Chelus fimbriata [49]; (b) Tuna [50]; (c) Sponges [51]; (d) Fly [52]; (e) Ground squirrels [53]. (All pictures are loyalty free).

(2) Retrieval by biological terminology related to the structure of WECs, as shown in Figure 3.

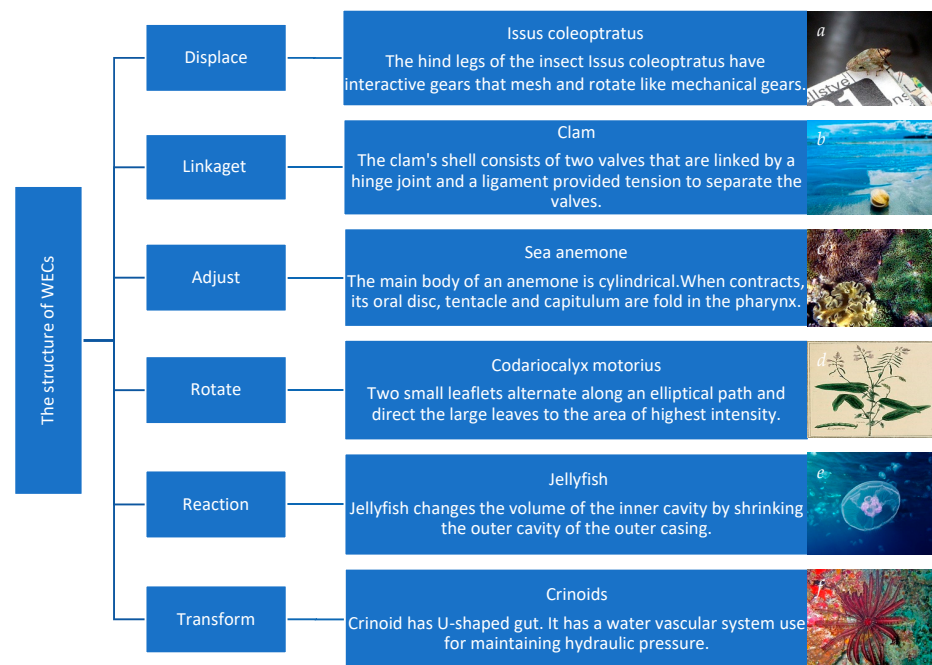

**Figure 3.** Biological entities retrieved by biological terminology related to the structure of WECs: (a) Issus coleoptratus [54]; (b) Clam [55]; (c) Sea anemone [56]; (d) Codariocalyx motorius [57]; (e) Jellyfish [58]; (f) Crinoids [59]. (All pictures are loyalty free).

(3) Retrieval by biological terminology related to the methods of power extraction of WECs, as shown in Figure 4.

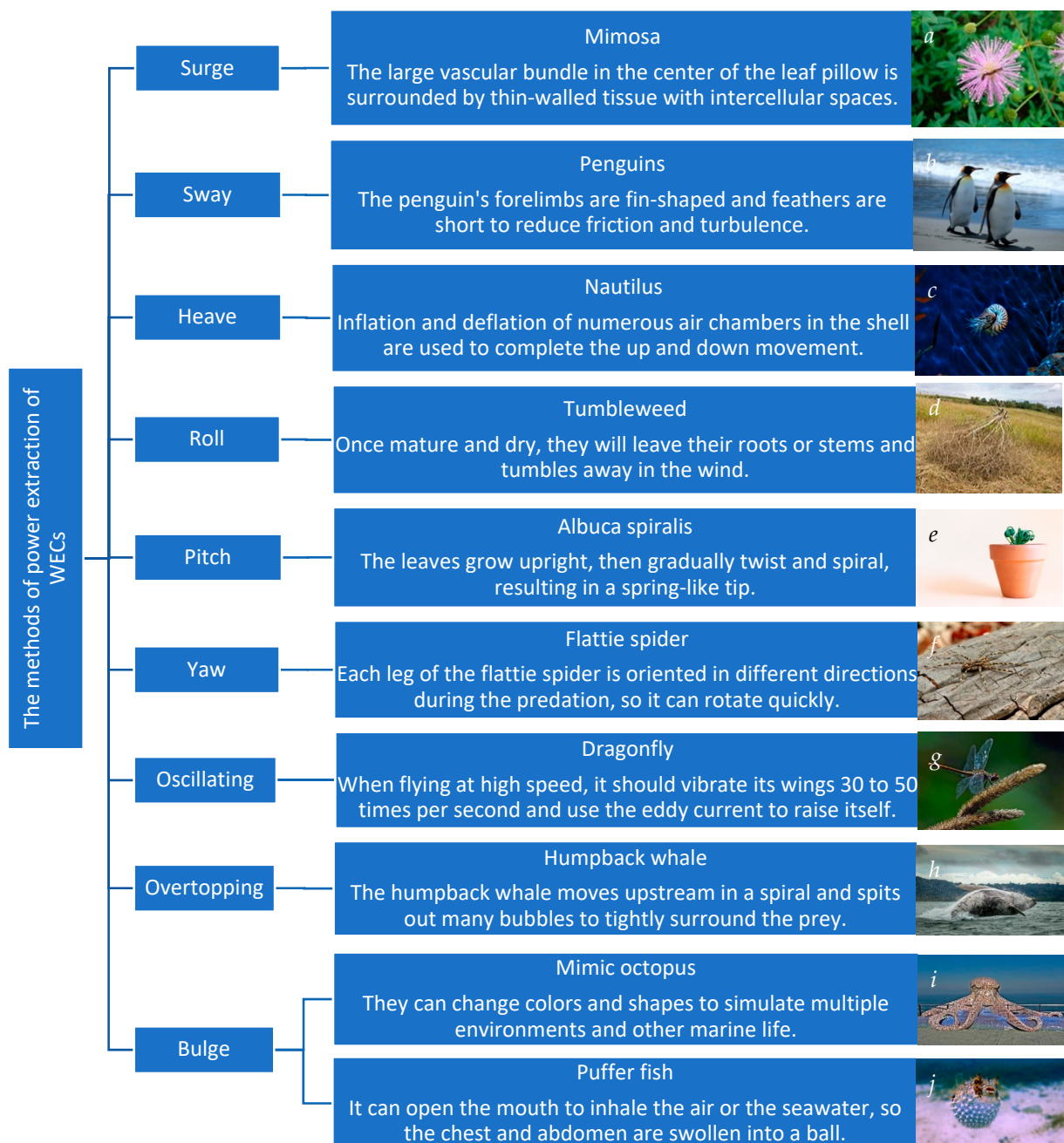

**Figure 4.** Biological entities retrieved by biological terminology related to the methods of power extraction of WECs: (a) Mimosa [60]; (b) Penguins [61]; (c) Nautilus [62]; (d) Tumbleweed [63]; (e) Albuca spiralis [64]; (f) Flattie spider [65]; (g) Dragonfly [66]; (h) Humpback whale [67]; (i) Mimic octopus [68]; (j) Puffer fish [69]. (All pictures are loyalty free).

The retrieval was performed using biological terminologies related to the engineering features of wave energy converters. These biological terminologies were selected from Table 6, together with the used keywords and obtained biological entities.

**Table 6.** Biological entities.

Features	Engineering Terminology	Biological Terminology	Key Words	Biological Entities
Functions of WECs	Captures energy	Capture	Bewitch + pray	Chelus fimbriata
	Extract energy	Extract	Draw out + food	Tuna
	Absorb energy	Absorb	Take in + food	Sponges
			Suck in + food	Fly
	Store energy	Store	Store + food	Ground squirrels
Structure of WECs	Displacing element	Displace	Move + mode	Issus coleoptratus
	Linkage element	Linkage	Linkage + mode	Clam
	Adjusting means	Adjust	Adjust + mode	Sea anemone
	Rotate part	Rotate	Rotate + mode	Codariocalyx motorius
	Reaction means	Reaction	Chemical reaction	Jellyfish
	Transforming means	Transform	Transform + mode	Crinoids
	Methods of power extraction	Surge	Surge	Inflate + mode
Sway		Sway	Totter + motion	Penguins
Heave		Heave	Heave + motion	Nautilus
Roll		Roll	Roll + motion	Tumbleweed
Pitch		Pitch	Twist + mode	Albuca spiralis
Yaw		Yaw	Slew + motion	Flattie spider
Oscillating		Oscillating	Vibrate + mode	Dragonfly
Overtopping		Overtopping	Overtopping + mode	Humpback whale
Bulge		Bulge	Change shape	Mimic octopus
	Bag + mode		5Puffer fish	

#### 4. Steps of Generating Design Ideas

After obtaining the biological entities, a new design concept for a WEC can be conceived by using the function, structure, or principles of the biological entities. The following flow chart shown in Figure 5 illustrates how to use the method proposed in this paper to search for valuable biological entities which could trigger design inspiration.

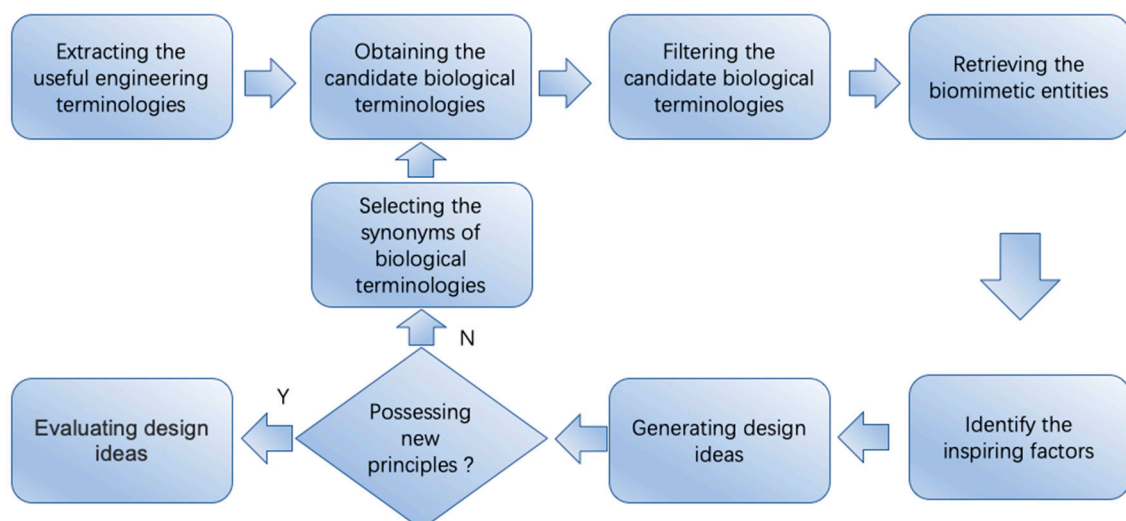
**Figure 5.** A guideline for generating design ideas.

#### 4.1. Extracting the Useful Engineering Terminologies

Useful engineering terminologies were provided in Section 3, and the remaining step is to select a terminology based on the engineering terminology set of function, structure and energy extraction method of the WEC. For instance, the widely used energy extraction method “surge” can be chosen as an engineering terminology.

#### 4.2. Obtaining the Candidate Biological Terminologies

With the help of the lexical dictionary WordNet, candidate biological terminologies can be obtained; for instance, “Surge” would result in:

“Surge”

billow, surge, heave, inflate, blow up, reflate

soar, soar up, soar upwards, surge, zoom

tide, surge, run, run off, run down, run out, flow, feed, course, flush, jet, gush, tide, surge, circulate, eddy, purl, whirlpool, swirl, whirl, waste pour, spill, stream, well out, etc.

#### 4.3. Filtering the Candidate Biological Terminologies

Many of the candidate biological terminologies for “surge” are related to human behavior; thus, those terminologies that are not related to animals and plants need to be manually deleted, followed by a further filtering using AskNature. Some of the biological terminologies remaining after filtering are shown in Table 7.

**Table 7.** Filtered biological terminologies.

Words with Synset (Semantic) Relation	
Surge	Billow, inflate, blow up, reflate, blow up, reflate.
	Soar, soar up, soar upwards, surge, zoom.
	tide, surge, run, run off, run down, run out, flow, feed, etc.
	Scend.

#### 4.4. Retrieving the Biomimetic Entities

According to the filtered biological terminologies related to “surge”, keywords composed of “biological terminologies plus animal” or “biological terminologies plus mode” can be obtained. With the help of these keywords, a variety of biological entities, such as nautilus, mimosa, tuna, sponges, clam, chelus fimbriata, jellyfish, crinoids, dragonfly, humpback whale, ramshorn snail, etc., can be retrieved, as shown in Table 8.

**Table 8.** Retrieved biological entities.

Biological Terminologies	Biological Entities
Billow	Big-eared octopus, feather stars.
Heave	Nautilus.
Inflate	Mimosa.
Tide	Hermit crab, sea anemone, jellyfish, bat star, limpet, sea lettuce.
Run	Bubble snail.
Flow	Chelus fimbriata, tuna, sponges, jellyfish.
Feed	Fly, jellyfish, crinoids.
Circulate	Sponges.
Eddy	Dragonfly.
Whirlpool	Ramshorn snail.
Waste	Sponges, crinoids.
Stream	Humpback whale.
Filter	Humpback whale.
Drain	Tuna, sponges, clam.

#### 4.5. Generating Design Ideas

In order to trigger design inspiration and generate design ideas, it is critical to identify the inspiring factors. Inspiring factors are closely related to the stimulus. These stimuli can be perceived by the senses, usually existing in many forms, including videos, pictures, and text [70,71]. Inspiration factors include the working principle, shape, structure, function, behavior, motion, material, texture, and color characteristics hidden in the stimulus [72]. Therefore, the terminologies describing these features can be extracted and used for stimulating design inspiration and conceiving new design ideas. Some biological entities are listed in Table 9.

**Table 9.** Stimuli and inspiring factors of biological entities.

Index	Biological Entities	Stimuli	Inspiring Factors
1	Big-eared octopus [73]	Body	Shape: a circus tent. Motion: inflate, billow.
2	Feather stars [74]	Arms	Structure: feathery fringes. Function: swim.
3	Nautilus [62]	Shell	Structure: numerous air chambers. Motion: up and down.
4	Bat star [75]	Body	Structure: webbing between arms.
		Arm	Shape: triangular. Function: rafting.
5	Bubble-rafting snails [76]	Body	Principle/Structure: trap air inside quick-setting mucus to make bubbles that glom together and form rafts.
6	Tuna [50]	Body	Shape: streamlined.
		Breastplate	Function: keep balance.
		Tail	Shape: half-moon shaped. Function: sprint forward quickly.
7	Crinoids [59]	Water vascular system	Principle: maintains hydraulic pressure. Structure: connected to the body cavity, not to the external seawater.
8	Dragonfly [66]	Wings	Shape: long and narrow. Function: vibrate. Behavior: vibrate wings 30 to 50 times per second.
		Wing eye	Function: eliminate the hazard of the flutter and make safe under high-frequency vibration.
9	Ramshorn snail [77]	Shell	Shape: planispiral coiled shells.
10	Humpback whale [67]	Mouth	Structure: special ligament structure between the upper and lower. Function: open. Behavior: open the mouth at an angle of 90 degrees.

It can be concluded from Table 9 that most of the obtained biological entities have interesting characteristics. In order to quickly generate new design ideas, we can use the analogy method to conceive new ideas. For example, the shape of big-eared octopus is similar to a circus tent, and can billow in the water. According to its shape and motion features, a design idea of WEC can be conceived. This conceptual WEC could be a floating WEC which can roll over in the sea with the waves, similar to a big-eared octopus. There could be a large ball inside the shell which can jump freely with the rolling of the shell. Some piezoelectric elements or hydraulic cylinders could be mounted on the inner wall of the shell. When the ball moves, it would create pressure on the piezoelectric elements, thereby directly converting the kinetic energy generated by the waves into electrical energy. Alternatively, the ball could push the hydraulic cylinder to generate high pressure liquid to drive the hydraulic motor, and finally drive the generator to generate electricity.

In addition, in order to generate more new design ideas, we can use the combination method to conceive. The characteristics of the structure and shape of each biological entity in Table 9 can be combined with some possible characteristics of WECs, listed

in Table 10. Through the combination of various characteristics, we can obtain several WEC design solutions, including some novel WEC design ideas, such as M2–S2–T3–I1–E3; namely, billow–triangular–webbing between arms–ocean surface–Electromagnetic induction. According to this information about the features of this new hypothetical WEC, we can conceive a WEC that floats and rolls on the water surface. It could be a polyhedron, such as a tetrahedron, octahedron, or icosahedron, composed of triangles. The surface of each triangle would be covered with light material, with each rod composing the triangle designed as an energy conversion device. When the polyhedron billows in the waves, the coils in the rod would move back and forth in a magnetic field, thereby converting wave energy into electrical energy.

With the continuous addition of new biological features, novel WEC design ideas will continue to increase. Of course, the transformation of each group of combined features into a WEC concept requires designers to have strong knowledge backgrounds and innovation abilities.

**Table 10.** Features table.

Features	Information					
	1	2	3	4	5	6
Motion(M)	Inflate	Billow	Up and down			
Shape(S)	Circus tent	Triangular	Streamlined	Half-moon shaped	Long and narrow	Planispiral coiled shells
Structure(T)	Feathery fringes	Unfolded	Webbing between arms	Connected to the body cavity	The ligament between the upper and lower	Bubbles glommed together
WEC Installation position(I)	Ocean surface	Under the ocean surface	Seabed	Onshore		
WEC Energy conversion method(E)	Air pressure energy-electrical energy	Hydraulic energy-electrical energy	Electromagnetic induction	Piezoelectric effect	Photoelectric effect	Thermoelectric effect

#### 4.6. Validation of Design Idea

According to the proposed method, a piezoelectric–electromagnetic wave energy conversion device used for piers of sea-crossing bridges can be designed by using the feature combination M3–S5–T6–I1–E3E4. As shown in Figure 6, this WEC has a simple structure and strong environmental adaptability. Thus, this design has been patented.

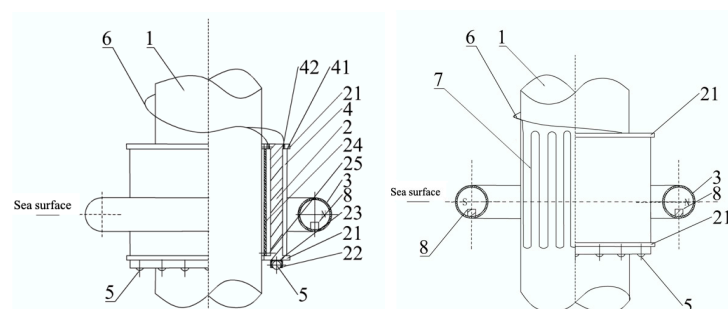

**Figure 6.** A piezoelectric–electromagnetic wave energy conversion device used for bridge piers [78]. 1, Bridge pier; 2, buoyancy sleeve; 21, protrusion; 22, fixing bracket; 23, fastening screw; 24, bottom plate; 25, fixing screw; 3, annular floating body; 4, piezoelectric film; 41, signal electrode; 42, ground electrode; 5, buoyancy ball; 6, wire; 7, serpentine wire; 8, heteropolar magnet.

In order to verify the feasibility of the idea, the TALOS WEC was obtained using the approach in Figure 7. Some modelling, simulation, and testing work was carried out at Lancaster University, UK [6]. The TALOS multi-axis WEC is shown in Figure 8, in which a heavy ball inside the TALOS device is supported by a plurality of hydraulic cylinders (or dampers) and springs connected to the wall of the hull. When the hull is pushed by waves, in all directions, the heavy ball is supposed to be stationary, such that the relative motion between the hull and the heavy ball could drive the hydraulic cylinders to pump the hydraulic fluid, which can be used to drive a hydraulic motor to generate electricity. Some initial studies have been conducted on the TALOS WEC at Lancaster University, including wave tank testing on a 1:100 scale model, as well as the PTO test using the test rig (details can be found in [6]).

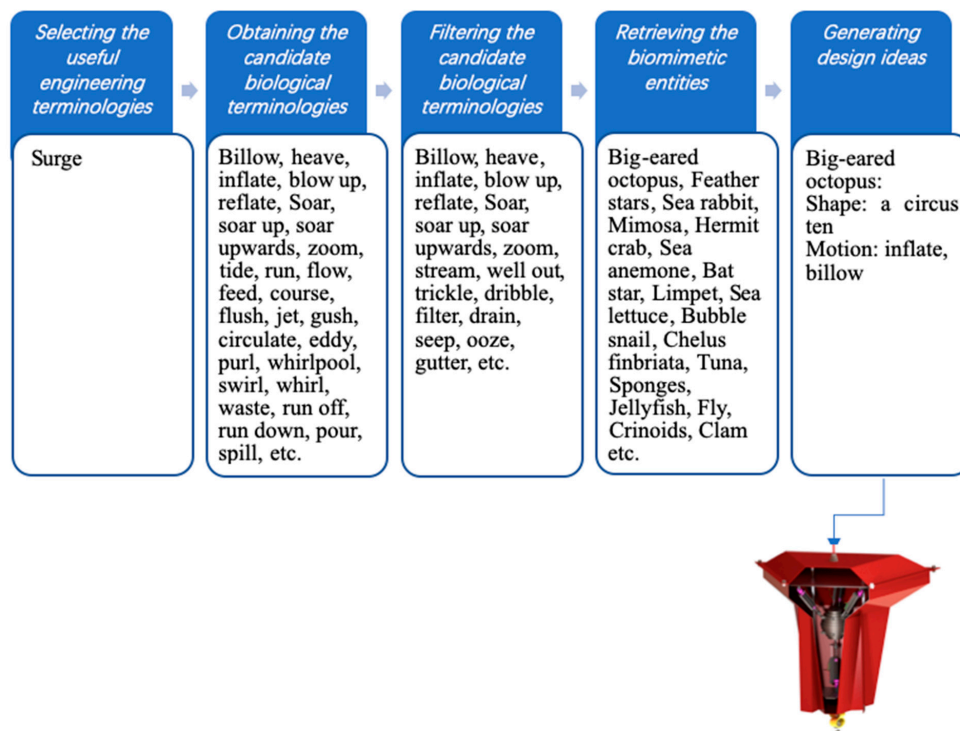

Figure 7. Flow chart of obtaining biological entities using “Surge”.

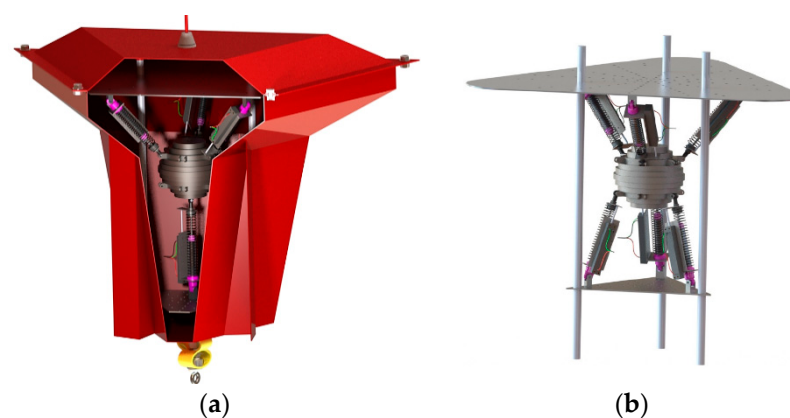

Figure 8. Prototype of the WEC [6]. (a) The TALOS WEC; (b) the hydraulic test rig.

Recently, UK Research and Innovation (UKRI) has announced its financial support of eight projects [79] aiming to unlock the potential of marine wave energy. The NHP-WEC for TALOS multi-axis WEC is one of the supported projects. The main objectives of the

project are to optimize the TALOS WEC, as well as the relevant PTO system and control technologies, in order to advance the TALOS WEC technology.

The ongoing research focus is on advancing the TALOS WEC, including the hydrodynamic optimization of the TALOS WEC, as well as the relevant PTO system. In addition, the project will also advance WEC's technology by developing essential device control and monitoring systems that are integrated with high-fidelity sea state forecasting using the SmartWave toolset [80]. This joint approach of TALOS and SmartWave would facilitate methodological synergies within these two areas of investigation, to bring the TALOS wave energy technology forward.

## 5. Discussions

In the process of searching for biological terminologies, it was found that the number of biological terminologies obtained by different engineering terminologies can be different. For example, the number of biological terminologies related to energy extraction methods is large, but the number of biological terminologies related to structure is small, as shown in Table 11.

**Table 11.** Comparison of the number of candidate biological terminologies obtainable from different engineering features.

Features	Number of Biological Terminologies	Total Number of Biological Terminologies
Functions of WECs	Capture	10
	Extract	13
	Absorb	17
	Store	5
Structure of WECs	Displace	6
	Linkage	1
	Adjust	12
	Rotate	5
	Reaction	2
	Transform	3
Methods of power extraction	Surge	38
	Sway	14
	Heave	15
	Roll	28
	Pitch	203
	Yaw	18
	Oscillating	20
	Overtopping	36
	Bulge	45

In the process of retrieving biological entities, AskNature is a helpful bio-retrieval site, as it contains a large number of biological cases and biological entities, as well as being a helpful tool for filtering biological terminologies via its very useful retrieving mode. When candidate biological terminologies, composed of phrases, are retrieved in AskNature, a large amount of irrelevant information can be generated. For example, if a biological entity is retrieved using the word "educa", search results will relate to education and educator, which include the word "educa". When searching with the phrase "take in", the system displays information about all words containing the word "in", such as



“inspired” and “Bio-industrial”; therefore, AskNature is suitable as a filtering tool for biological terminologies, but if AskNature’s search results are used for statistical analysis, it is possible to come to inaccurate conclusions. In addition, when using AskNature to filter candidate biological terminologies, it was found that manually filtered words will still be displayed in related cases. Therefore, AskNature can be used to check the manually filtered biological terminologies to reduce the error filtering of biological terminologies.

## 6. Concluding Remarks

This paper illustrates how to obtain valuable biological entities for the design of novel WECs. The proposed method could provide a large number of biological inspiration resources, as well as valuable biological entities related to the principles and goals for a novel WEC, and from which a useful biological identity may be obtained to inspire the innovation and design of a novel wave energy converter. The proposed method includes the following steps:

- (1) By using WordNet, a large number of candidate biological terminologies can be generated.
- (2) Using manual filtering and the filtering tools of AskNature, candidate biological terminologies can be acquired.
- (3) Using the engineers’ understanding of the candidate biological terminologies to remove any deviations in the filtering process.
- (4) In the case of a large number of filtered biological terminologies, it is necessary to develop a computer-aided tool for filtering the candidate biological terminologies, including selection of the appropriate biological terminology, in order to obtain an ideal biological entity.
- (5) Selecting a candidate biological terminology with a small amount of information that can be retrieved may be a shortcut to obtaining a novel biological entity for this new design process.

A utilization of the present method demonstrates how to obtain ideal biological entities. It should be noted that finding relevant biological entities may provide inspiration for the design of innovative devices, but would not solve all WEC design questions. After all, improvements and optimizations must be carried out during the development stages of wave energy converters, similar to other bionic engineering problems.

**Author Contributions:** H.Z., conceptualization, data curation, formal analysis, investigation, methodology, resources, software, visualization, and writing—original draft; W.S., writing—reviewing and editing; Z.Z., writing—reviewing and editing; G.A., conceptualization, project administration, resources, software, supervision, validation, visualization, and writing—reviewing and editing. All authors have read and agreed to the published version of the manuscript.

**Funding:** This research was carried out mainly by the first author while visiting at the Lancaster University Renewable Energy Group, under funding support from the Zhejiang Ocean University.

**Institutional Review Board Statement:** Not applicable.

**Informed Consent Statement:** Not applicable.

**Data Availability Statement:** Not applicable.

**Conflicts of Interest:** The authors declare no conflict of interest.

## References

1. Ning, D.; Zhao, X.; Götteman, M.; Kang, H. Hydrodynamic performance of a pile-restrained WEC-type floating breakwater: An experimental study. *Renew. Energy* **2016**, *95*, 531–541. [[CrossRef](#)]
2. Kara, F. Hydrodynamic performances of wave energy converter arrays in front of a vertical wall. *Ocean Eng.* **2021**, *235*, 109459. [[CrossRef](#)]
3. Sheng, W. Power performance of BBDB OWC wave energy converters. *Renew. Energy* **2019**, *132*, 709–722. [[CrossRef](#)]
4. Akimoto, H.; Tanaka, K. Conceptual study of a drag type water turbine for electricity generation from wave power. In Proceedings of the 12th International Symposium on Fluid Control, Measurement and Visualization, Nara, Japan, 18–23 November 2013.

5. Falcão, A.; Gato, L.; Nunes, E. A novel radial self-rectifying air turbine for use in wave energy converters. Part 2. Results from model testing. *Renew. Energy* **2013**, *53*, 159–164. [[CrossRef](#)]
6. Aggidis, G.A.; Taylor, C.J. Overview of wave energy converter devices and the development of a new multi-axis laboratory prototype. *IFAC-PapersOnline* **2017**, *50*, 15651–15656. [[CrossRef](#)]
7. Noad, I.F.; Porter, R. Optimisation of arrays of flap type oscillating wave surge converters. *Appl. Ocean. Res.* **2015**, *50*, 237–253. [[CrossRef](#)]
8. Sogeti-Hightech. Sea Heart Converter. Available online: <https://www.sogeti-hightech.fr/en/sea-heart-converter/> (accessed on 30 August 2019).
9. Whittaker, T.; Folley, M. Nearshore oscillating wave surge converters and the development of Oyster. *Philos. Trans. R. Soc. A Math. Phys. Eng. Sci.* **2012**, *370*, 345–364. [[CrossRef](#)] [[PubMed](#)]
10. Yemm, R.; Pizer, D.; Retzler, C.; Henderson, R. Pelamis: Experience from concept to connection. *Philos. Trans. R. Soc. London. Ser. A Math. Phys. Eng. Sci.* **2012**, *370*, 365–380. [[CrossRef](#)]
11. Wave Dragon. Available online: <http://www.wavedragon.net> (accessed on 30 August 2019).
12. Chaplin, J.R.; Heller, V.; Farley, F.J.M.; Hearn, G.E.; Rainey, R.C.T. Laboratory testing the Anaconda. *Philos. Trans. R. Soc. London. Ser. A Math. Phys. Eng. Sci.* **2012**, *370*, 403–424. [[CrossRef](#)] [[PubMed](#)]
13. BPS. BioWAVE. Available online: <http://bps.energy/biowave> (accessed on 30 August 2019).
14. Ecomerit Technologies. Centipod. Available online: <http://www.ecomerittech.com/centipod.php> (accessed on 30 August 2019).
15. AeroVironment. Marine Energy Systems. Available online: <http://www.avinc.com/innovative-solutions/clean-energy-water> (accessed on 30 August 2019).
16. Katiyar, N.K.; Goel, G.; Hawi, S. Nature-inspired materials: Emerging trends and prospects. *NPG Asia Mater.* **2021**, *13*, 1–16. [[CrossRef](#)]
17. du Plessis, A.; Broeckhoven, C.; Yadroitsava, I.; Yadroitsev, I.; Hands, C.H.; Kunju, R.; Bhate, D. Beautiful and Functional: A Review of Biomimetic Design in Additive Manufacturing. *Addit. Manuf.* **2019**, *27*, 408–427. [[CrossRef](#)]
18. Ling, S.; Qin, Z.; Huang, W.; Cao, S.; Kaplan, D.L.; Buehler, M.J. Design and function of biomimetic multilayer water purification membranes. *Sci. Adv.* **2017**, *3*, e1601939. [[CrossRef](#)] [[PubMed](#)]
19. Honey, K.T.; Pagani, G.A. Bio inspired energy: Biomimicry innovations for energy sustainability. In *Complex Systems Summer School Proceedings*; Santa Fe Institute: Santa Fe, NM, USA, 2013; pp. 1–4.
20. Zhang, H.; Aggidis, G.A. Nature rules hidden in the biomimetic wave energy converters. *Renew. Sustain. Energy Rev.* **2018**, *97*, 28–37. [[CrossRef](#)]
21. Tan, R.; Liu, W.; Cao, G.; Shi, Y. Creative design inspired by biological knowledge: Technologies and methods. *Front. Mech. Eng.* **2019**, *14*, 1–14. [[CrossRef](#)]
22. Festo Corporate. BionicSoftArm. Available online: <https://www.festo.com/group/en/cms/13527.htm> (accessed on 30 August 2019).
23. Goel, A.K.; Rugaber, S.; Vattam, S. Structure, behavior, and function of complex systems: The structure, behavior, and function modeling language. *Artif. Intell. Eng. Des. Anal. Manuf.* **2009**, *23*, 23–35. [[CrossRef](#)]
24. Wiltgen, B.; Vattam, S.; Helms, M.; Goel, A.K.; Yen, J. Learning Functional Models of Biological Systems for Biologically Inspired Design. In *Proceedings of the 2011 IEEE 11th International Conference on Advanced Learning Technologies*, Athens, GA, USA, 6–8 July 2011; IEEE: Piscataway, NJ, USA, 2011; pp. 355–357.
25. Helms, M. DANE: Design by Analogy to Nature Engine. Available online: <http://dilab.cc.gatech.edu/dane/> (accessed on 30 August 2019).
26. Vattam, S. DANE: Fostering Creativity in and through Biologically Inspired Design. In *Proceedings of the 1st International Conference on Design Creativity*, Kobe, Japan, 29 November–1 December 2010; pp. 115–122.
27. Chakrabarti, A.; Sarkar, P.; Leelavathamma, B.; Nataraju, B. A functional representation for aiding biomimetic and artificial inspiration of new ideas. *Artif. Intell. Eng. Des. Anal. Manuf.* **2005**, *19*, 113–132. [[CrossRef](#)]
28. Sartori, J.; Pal, U.; Chakrabarti, A. A methodology for supporting “transfer” in biomimetic design. *Artif. Intell. Eng. Des. Anal. Manuf.* **2010**, *24*, 483–506. [[CrossRef](#)]
29. Gero, J.S. Design prototypes: A knowledge representation schema for design AI Mag. *AI Mag.* **1990**, *11*, 26.
30. Chiu, I.; Shu, L.H. Biomimetic design through natural language analysis to facilitate cross-domain information retrieval. *Artif. Intell. Eng. Des. Anal. Manuf.* **2007**, *21*, 45–59. [[CrossRef](#)]
31. Chiu, I.; Shu, L. Using language as related stimuli for concept generation. *Artif. Intell. Eng. Des. Anal. Manuf.* **2007**, *21*, 103–121. [[CrossRef](#)]
32. Cheong, H.; Shu, L.H.; Stone, R.B.; McAdams, D.A. Translating Terms of the Functional Basis into Biologically Meaningful Words. In *Proceedings of the International Design Engineering Technical Conferences and Computers and Information in Engineering Conference*, Brooklyn, NY, USA, 3–6 August 2008.
33. Cheong, H.; Chiu, I.; Shu, L.H.; Stone, R.B.; McAdams, D.A. Biologically Meaningful Keywords for Functional Terms of the Functional Basis. *J. Mech. Des.* **2011**, *133*, 021007. [[CrossRef](#)]
34. Benyus, J. The Biomimicry Institute—Inspiring Sustainable Innovation. 2006. Available online: <https://biomimicry.org/> (accessed on 30 August 2019).
35. Biology Online. Available online: <http://www.biology-online.org> (accessed on 30 August 2019).

36. Fraunhofer BIOPS. Available online: <http://nature4innovation.com/> (accessed on 30 August 2019).
37. Stroble, J.K.; Stone, R.B.; McAdams, D.A.; Goeke, M.S.; Watkins, S.E. Automated Retrieval of Non-Engineering Domain Solutions to Engineering Problems. In Proceedings of the 19th CIRP Design Conference, Cranfield, Bedfordshire, UK, 30–31 March 2009; pp. 78–85.
38. Spiliopoulou, E.; Rugaber, S.; Goel, A.; Chen, L.; Wiltgen, B.; Jagannathan, A.K. Intelligent Search for Biologically Inspired Design. In Proceedings of the 20th International Conference on Intelligent User Interfaces Companion, Atlanta, GA, USA, 29 March–1 April 2015. ACM 978-1-4503-3308-5/15/03.
39. Chen, J.L.; Lee, C.L. Developing Sustainable Innovative Products for the Bottom of the Pyramid by Biomimetic Design Concepts. *Procedia CIRP* **2017**, *61*, 629–634. [[CrossRef](#)]
40. Salter, S.H. Wave Power. *Nature* **1974**, *249*, 720–724. [[CrossRef](#)]
41. Wello. The Penguin Wave Energy Converter. Available online: <http://www.wello.eu/en/penguin> (accessed on 30 August 2019).
42. OceanMil. Wave Rotor Technology. Available online: <https://sites.google.com/site/oceanmilltest/services> (accessed on 30 August 2019).
43. OWC Wave Energy. LIMPET. Available online: <http://owcwaveenergy.weebly.com/wavegen.html> (accessed on 30 August 2019).
44. Miller, G.A. WordNet: A Lexical Database for English. *Commun. ACM* **1995**, *38*, 39–41. [[CrossRef](#)]
45. Nagel, J.K.S.; Stone, R.B.; McAdams, D.A. An Engineering-to-Biology Thesaurus for Engineering Design. In Proceedings of the ASME 2010 International Design Engineering Technical Conferences and Computers and Information in Engineering Conference, Montreal, QC, Canada, 15–18 August 2010; pp. 117–128.
46. Mckean, E. *The New Oxford American Dictionary*; Oxford University Press: Oxford, UK, 2005.
47. Lawrence, E.; Holmes, S. *Henderson's Dictionary of Biological Terms*; Wiley: New York, NY, USA, 1989.
48. Matrin, E.; Hine, R.S. *Oxford Dictionary of Biology*; Oxford University Press: Oxford, UK, 2000.
49. Wikimedia Commons. Chelus Fimbriata. Available online: [https://upload.wikimedia.org/wikipedia/commons/thumb/7/7f/2009\\_Chelus\\_fimbriatus.JPG/500px-2009\\_Chelus\\_fimbriatus.JPG](https://upload.wikimedia.org/wikipedia/commons/thumb/7/7f/2009_Chelus_fimbriatus.JPG/500px-2009_Chelus_fimbriatus.JPG) (accessed on 21 March 2022).
50. Unsplash. Tuna. Available online: <https://images.unsplash.com/photo-1566177229701-8895c29b9c68?crop=entropy&cs=tinyrgb&fit=max&fm=jpg&ixid=MnwMjA3fDB8MXxzZWZyY2h8MXx8dHVuYXx8MHx8fHwXNjI2NjcyODEw&ixlib=rb-1.2.1&q=80&w=1080> (accessed on 21 March 2022).
51. Wikimedia commons. Sponges. Available online: [https://upload.wikimedia.org/wikipedia/commons/thumb/2/20/Aplysina\\_archeri\\_\(Stove-pipe\\_Sponge-pink\\_variation\).jpg/450px-Aplysina\\_archeri\\_\(Stove-pipe\\_Sponge-pink\\_variation\).jpg](https://upload.wikimedia.org/wikipedia/commons/thumb/2/20/Aplysina_archeri_(Stove-pipe_Sponge-pink_variation).jpg/450px-Aplysina_archeri_(Stove-pipe_Sponge-pink_variation).jpg) (accessed on 21 March 2022).
52. Wikimedia commons. Fly. Available online: [https://upload.wikimedia.org/wikipedia/commons/thumb/a/a7/Fly\\_\(Diptera\)\\_-\\_Guelph%2C\\_Ontario\\_19.jpg/1280px-Fly\\_\(Diptera\)\\_-\\_Guelph%2C\\_Ontario\\_19.jpg](https://upload.wikimedia.org/wikipedia/commons/thumb/a/a7/Fly_(Diptera)_-_Guelph%2C_Ontario_19.jpg/1280px-Fly_(Diptera)_-_Guelph%2C_Ontario_19.jpg) (accessed on 21 March 2022).
53. Wikimedia commons. Ground Squirrels. Available online: [https://upload.wikimedia.org/wikipedia/commons/thumb/f/fe/Richardson\\_T1\\_textquoterights\\_Ground\\_Squirrel\\_\(Oregon\).jpg/800px-Richardson\\_T1\\_textquoterights\\_Ground\\_Squirrel\\_\(Oregon\).jpg](https://upload.wikimedia.org/wikipedia/commons/thumb/f/fe/Richardson_T1_textquoterights_Ground_Squirrel_(Oregon).jpg/800px-Richardson_T1_textquoterights_Ground_Squirrel_(Oregon).jpg) (accessed on 21 March 2022).
54. Wikimedia commons. Issus Coleoptratus. Available online: [https://upload.wikimedia.org/wikipedia/commons/thumb/7/74/Planthopper%2C\\_Issus\\_coleoptratus%2C\\_Issidae\\_-\\_Flickr\\_-\\_gailhampshire.jpg/494px-Planthopper%2C\\_Issus\\_coleoptratus%2C\\_Issidae\\_-\\_Flickr\\_-\\_gailhampshire.jpg](https://upload.wikimedia.org/wikipedia/commons/thumb/7/74/Planthopper%2C_Issus_coleoptratus%2C_Issidae_-_Flickr_-_gailhampshire.jpg/494px-Planthopper%2C_Issus_coleoptratus%2C_Issidae_-_Flickr_-_gailhampshire.jpg) (accessed on 21 March 2022).
55. Unsplash. Clam. Available online: <https://images.unsplash.com/photo-1598547240827-812a186e0122?ixlib=rb-1.2.1&ixid=MnwMjA3fDB8MHxwaG90by1wYWdlfHx8fGVufDB8fHx8&auto=format&fit=crop&w=1331&q=80> (accessed on 21 March 2022).
56. Wikimedia commons. Sea Anemone. Available online: [https://upload.wikimedia.org/wikipedia/commons/thumb/4/47/Sea\\_anemones\\_mad.JPG/800px-Sea\\_anemones\\_mad.JPG](https://upload.wikimedia.org/wikipedia/commons/thumb/4/47/Sea_anemones_mad.JPG/800px-Sea_anemones_mad.JPG) (accessed on 21 March 2022).
57. Wikimedia commons. Codariocalyx Motorius. Available online: [https://upload.wikimedia.org/wikipedia/commons/thumb/2/2a/Elements\\_of\\_the\\_science\\_of\\_botany%2C\\_as\\_established\\_by\\_Linnaeus%3B\\_with\\_examples\\_to\\_illustrate\\_the\\_classes\\_and\\_orders\\_of\\_his\\_system\\_\(1812\)\\_%2821254532612%29.jpg/208px-Elements\\_of\\_the\\_science\\_of\\_botany%2C\\_as\\_established\\_by\\_Linnaeus%3B\\_with\\_examples\\_to\\_illustrate\\_the\\_classes\\_and\\_orders\\_of\\_his\\_system\\_\(1812\)\\_%2821254532612%29.jpg](https://upload.wikimedia.org/wikipedia/commons/thumb/2/2a/Elements_of_the_science_of_botany%2C_as_established_by_Linnaeus%3B_with_examples_to_illustrate_the_classes_and_orders_of_his_system_(1812)_%2821254532612%29.jpg/208px-Elements_of_the_science_of_botany%2C_as_established_by_Linnaeus%3B_with_examples_to_illustrate_the_classes_and_orders_of_his_system_(1812)_%2821254532612%29.jpg) (accessed on 21 March 2022).
58. Wikimedia commons. Jellyfish. Available online: [https://upload.wikimedia.org/wikipedia/commons/thumb/2/27/Moon\\_jellyfish\\_at\\_Gota\\_Sagher.JPG/1597px-Moon\\_jellyfish\\_at\\_Gota\\_Sagher.JPG](https://upload.wikimedia.org/wikipedia/commons/thumb/2/27/Moon_jellyfish_at_Gota_Sagher.JPG/1597px-Moon_jellyfish_at_Gota_Sagher.JPG) (accessed on 21 March 2022).
59. Wikimedia commons. Crinoids. Available online: [https://upload.wikimedia.org/wikipedia/commons/thumb/3/38/Colobometridae\\_-\\_Cenometra\\_bella.jpg/500px-Colobometridae\\_-\\_Cenometra\\_bella.jpg](https://upload.wikimedia.org/wikipedia/commons/thumb/3/38/Colobometridae_-_Cenometra_bella.jpg/500px-Colobometridae_-_Cenometra_bella.jpg) (accessed on 21 March 2022).
60. Wikimedia commons. Mimosa. Available online: <https://tse-2-mm.cn.bing.net/th/id/OIP-C.4Q5CTcUrH5zQyfm4lzAKpgHaFj?pid=ImgDet&rs=1> (accessed on 21 March 2022).
61. Wikimedia commons. Penguins. Available online: [https://upload.wikimedia.org/wikipedia/commons/thumb/8/8e/King\\_Penguins\\_walking\\_on\\_the\\_beach\\_\(5848675669\).jpg/1200px-King\\_Penguins\\_walking\\_on\\_the\\_beach\\_\(5848675669\).jpg](https://upload.wikimedia.org/wikipedia/commons/thumb/8/8e/King_Penguins_walking_on_the_beach_(5848675669).jpg/1200px-King_Penguins_walking_on_the_beach_(5848675669).jpg) (accessed on 21 March 2022).
62. Unsplash. Nautilus. Available online: <https://images.unsplash.com/photo-1514906438676-20da14bb8dad?ixlib=rb-1.2.1&ixid=MnwMjA3fDB8MHxwaG90by1wYWdlfHx8fGVufDB8fHx8&auto=format&fit=crop&w=870&q=80> (accessed on 21 March 2022).

63. Wikimedia commons. Tumbleweed. Available online: [https://upload.wikimedia.org/wikipedia/commons/thumb/2/27/Rapistrum\\_perenne\\_sl29.jpg/240px-Rapistrum\\_perenne\\_sl29.jpg](https://upload.wikimedia.org/wikipedia/commons/thumb/2/27/Rapistrum_perenne_sl29.jpg/240px-Rapistrum_perenne_sl29.jpg) (accessed on 21 March 2022).
64. Unsplash. Albuca spiralis. Available online: <https://images.unsplash.com/photo-1587280872148-32e057fb7966?ixlib=rb-1.2.1&ixid=MnwxMjA3fDB8MHxzZWZFY2h8MTU4fHxmbGF0dGllJTlwc3BpcmFsaXN8ZW58MHx8MHx8&auto=format&fit=crop&w=500&q=60> (accessed on 21 March 2022).
65. Unsplash. Flattie Spider. Available online: <https://images.unsplash.com/photo-1581789164386-b3d43c0c5e11?ixlib=rb-1.2.1&ixid=MnwxMjA3fDB8MHxzZWZFY2h8MTU4fHxmbGF0dGllJTlwc3BpcmFsaXN8ZW58MHx8MHx8&auto=format&fit=crop&w=500&q=60> (accessed on 21 March 2022).
66. Wikimedia commons. Dragonfly. Available online: [https://upload.wikimedia.org/wikipedia/commons/thumb/3/32/Dragonfly\\_in\\_autumn\\_-\\_Cozachyi\\_island%2C\\_Kyiv.jpg/1200px-Dragonfly\\_in\\_autumn\\_-\\_Cozachyi\\_island%2C\\_Kyiv.jpg](https://upload.wikimedia.org/wikipedia/commons/thumb/3/32/Dragonfly_in_autumn_-_Cozachyi_island%2C_Kyiv.jpg/1200px-Dragonfly_in_autumn_-_Cozachyi_island%2C_Kyiv.jpg) (accessed on 21 March 2022).
67. Wikimedia commons. Humpback Whale. Available online: [https://upload.wikimedia.org/wikipedia/commons/f/f6/Humpback\\_whale\\_breaching\\_off\\_the\\_coast\\_of\\_Choco%2C\\_Colombia.jpg](https://upload.wikimedia.org/wikipedia/commons/f/f6/Humpback_whale_breaching_off_the_coast_of_Choco%2C_Colombia.jpg) (accessed on 21 March 2022).
68. Wikimedia commons. Mimic Octopus. Available online: [https://upload.wikimedia.org/wikipedia/commons/thumb/a/a2/Polbo\\_no\\_paseo\\_Mar%C3%ADtimo%2C\\_A\\_Coru~na\\_\(5939722424\).jpg/240px-Polbo\\_no\\_paseo\\_Mar%C3%ADtimo%2C\\_A\\_Coru~na\\_\(5939722424\).jpg](https://upload.wikimedia.org/wikipedia/commons/thumb/a/a2/Polbo_no_paseo_Mar%C3%ADtimo%2C_A_Coru~na_(5939722424).jpg/240px-Polbo_no_paseo_Mar%C3%ADtimo%2C_A_Coru~na_(5939722424).jpg) (accessed on 21 March 2022).
69. Unsplash. Puffer fish. Available online: <https://images.unsplash.com/photo-1618409869565-b0e4eabaf0fa?ixlib=rb-1.2.1&ixid=MnwxMjA3fDB8MHxwaG90by1wYWdlfHx8fGVufDB8fHx8&auto=format&fit=crop&w=1331&q=80> (accessed on 21 March 2022).
70. Julian, V. Biomimetics: Strategies for product design inspired by nature—a mission to the Netherlands and Germany. In *Report of a DTI Global Watch Mission*; DTI: London, UK, 2007.
71. Wen, H.I.; Zhang, S.J.; Hapeshi, K.; Wang, X.F. An innovative methodology of product design from nature. *J. Bionic Eng.* **2008**, *5*, 75–84. [[CrossRef](#)]
72. Hsiao, H.C.; Chou, W.C. Using biomimetic design in a product design course. *World Trans. Eng. Technol. Educ.* **2007**, *6*, 31–35.
73. Nautilus Live. Big-Eared Octopus. Available online: <https://nautiluslive.org> (accessed on 18 June 2020).
74. Australian Geographic. Feather Stars. Available online: <https://www.australiangeographic.com.au/topics/wildlife/2017/08/weird-sea-creatures/> (accessed on 18 June 2020).
75. Wanweibaikē. Bat Star. Available online: <https://en.wanweibaikē.com/wiki-Bat%20star> (accessed on 18 June 2020).
76. Phys Org. Bubble-Rafting Snails. Available online: <https://phys.org/news/2011-10-bubble-rafting-snails-eggs.html> (accessed on 18 June 2020).
77. The Aquarium Wiki. Ramshorn Snail. Available online: [http://www.theaquariumwiki.com/wiki/Gyraulus\\_sp](http://www.theaquariumwiki.com/wiki/Gyraulus_sp) (accessed on 18 June 2020).
78. Zhang, H. A Piezoelectric-Electromagnetic Wave Energy Conversion Device Used for Bridge Piers. China No. 201921658634.0, 30 September 2019.
79. UKRI. Projects to Unlock the Potential of Marine Wave Energy 2021. Available online: <https://www.ukri.org/news/projects-to-unlock-the-potential-of-marine-wave-energy/> (accessed on 1 November 2021).
80. SmartWave. High Resolution Sea State Simulation with SmartWave 2021. Available online: <https://www.offshorewindlibrary.com/smartwave/> (accessed on 15 December 2021).