



WILEFKO

WAVE ENERGY
*EXTRACTING KINETIC ENERGY FROM
OCEAN BRAKING WAVES*



W I L E F K O

GENERATE ELECTRICITY AND SEAWATER DESALINATION



Proyecto apoyado por
CORFO
sueña empresa crece





WILEFKO



- ↓ Our primary goal, is to develop a world-class business to meet the demand for clean and renewable energy, with high returns for our investors.
- ↓ We offer participation to one or more strategic partners for international deployment of our technology.
- ↓ Our project offers real opportunities to participate, by providing funds to develop the technology, obtaining paybacks and returns for these contributions.
- ↓ Satisfy part of the demand for water and electricity of 3500 isolated communities in Chile, with small-Size Generation.
- ↓ We seek to establish the short test term partnership, in order to build the first plant of 20 MW in Chile.
- ↓ We create for the formation of WILEFKO SPA, a joint stock company, which will be responsible for implementation and logistics to achieve adequate margins and high return over investment to our shareholders

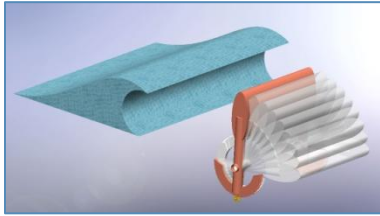

Begin-2011

Wave system composed of oscillating bodies with an intermediate stage of accumulation of compressed air to generate electricity and seawater desalination

The estimated energy and power based on those laboratory results are as follows: for a 20 MW plant located 1000m away from the coastline, it can obtain averaged energy of 175,000 MWh/yrs in Chile, If we apply the price of cost margin at \$US 140 per MWh, its generated income will be \$US 35 MM per year.



Exclusiveness Rights over the technology until year 2031, in Chile and Worldwide, for 27 country.

Next-2015

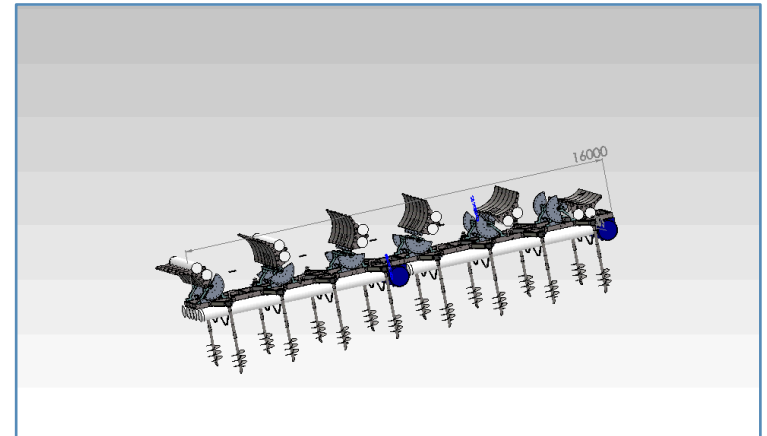



WILEFKO

MARKET

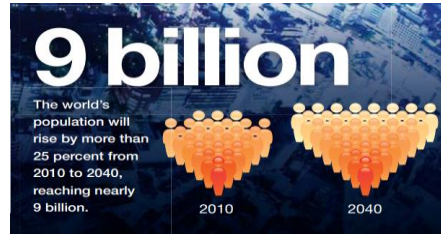

2010

- ↓ 1500 MM No electricity **
- ↓ 800 MM waterless *
- ↓ 2.600 MM without sanitary services

2040

- ↓ Increase 2.400 MM **
- ↓ Power demand 16.000 TWh/ys**
- ↓ Residential consumption 75%**



Chile

- Price: Substation Quillota average US\$237 MWh , 2014
- 20% /25 ERNC, law 20.257
- Location potential 3,500
- 4200 Km coastline
- 240.000 MW available
- NCRE demand, 23.000GWh/Yrs, 2025
- NCRE potential Market US\$8.700 MM, 2025

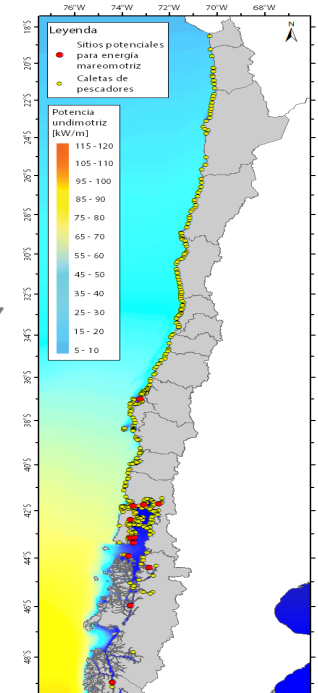

• Source : Water Sanitation Health, WHO/UNICEF joint , monitoring report 2012. Levels & Trends in Child Mortality report written by OMS y UNICEF, 2012

↓ Empowered citizens with higher conscience of environmental pressures are demanding clean and not contaminating sources of energy. Thus, by 2050, renewable energies will be the dominant sources of energy. Figure 8-2.

↓ Estimated incomes from ocean energies at commercial stages by year 2030, are shown in fig 4-2 y 4-4. Market share near 5% by year 2050, considering the worldwide energy matrix.

POTENTIAL MARKET

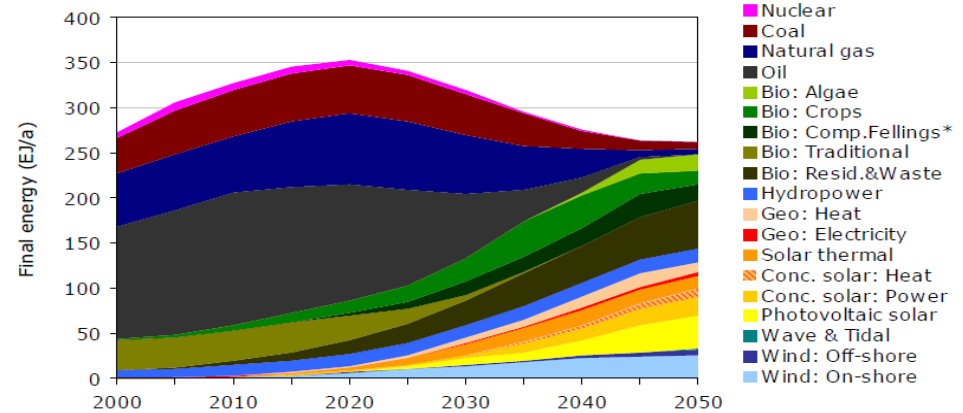

Figure 4 - 2 Global energy supply in the Scenario, split by source. (*Complementary fellings include the sustainable share of traditional biomass use.²⁵)

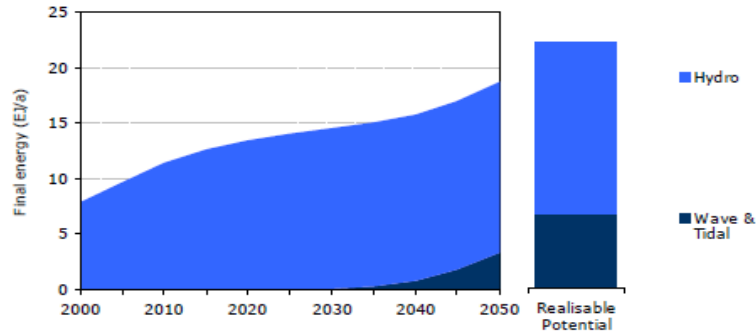

Figure 4 - 4 Global deployment potential of hydro and ocean power. (Left: Evolution of deployment potential over time, right: Maximum feasible potential)

Wave & Tidal energy 2050
5% = 800 TWh/yr



WILEFKO

↓ There aren't any dominant wave energy projects in the international market yet; most are at experimental stage or at early stages of commercialization

↓ Light blue circles identifies the international locations of economic interest, over 25 KW power per meter.

28.000 TWh/yr

Annual net theoretical coastal power worldwide wave energy**



POTENTIAL MARKET

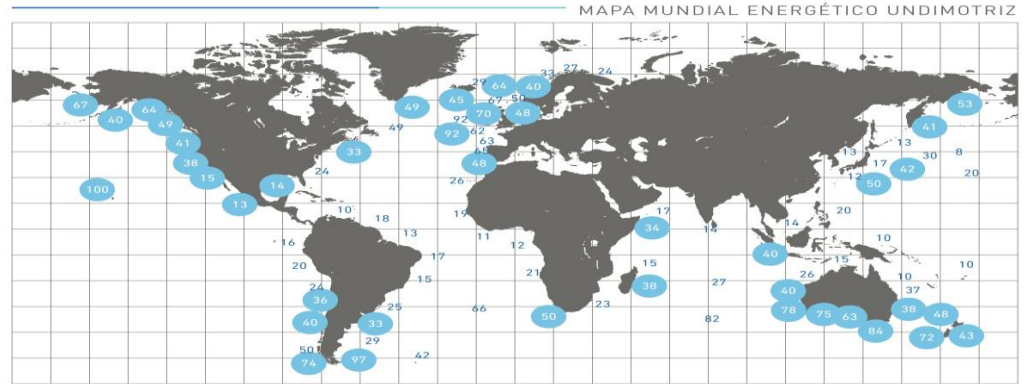

Elaboración: Grupo I+D+i Energía Undimotriz
Fuente de datos: Wave Energy Paper. (1991) I. Mech. E., European Directory of Renewable Energy

PATENTE

Theoretical wave energy potential estimated MW

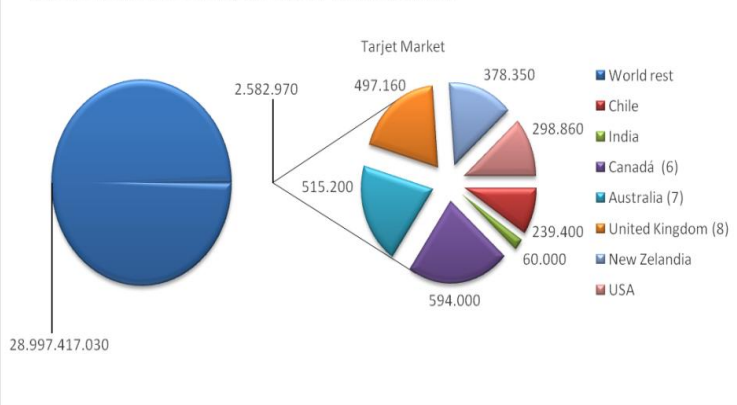

Installed capacity according to Wilefko efficiency 32% de Wilefko Calculus based on 1% of use of coastline***

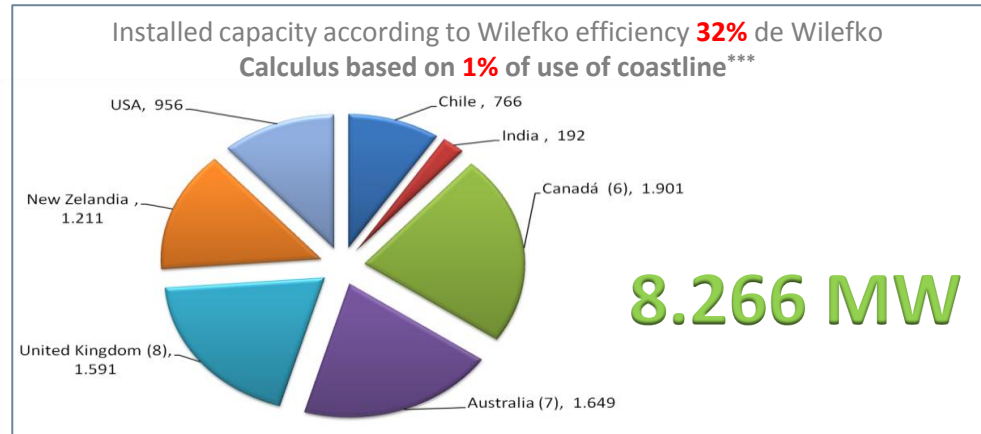

8.266 MW

meeting the energy consumption of over 8 million families and avoiding 56 million tones of CO2 emissions per year.

*** [References](#)

Note:** The results presented in Mork et al. (2010) regarding the overall theoretical global potential for wave energy are consistent with other studies (Cornett, 2008).

Countries, satisfy current domestic demand

	Population total Milliones (1)	Electric power consumption per capital KWh (1)	people without electricity MM 2013 (1)	Consumption GWh/yr anuales 2012 (1)	Generacion electric NO fósil % (1)	Average price US\$ cent/KWh anual (2)	Electricity for industry MWh US\$ (3)	Electricity for households MWh US\$ (3)	Electricity demand 2025 anuales MWh/yr (11)	Electricity demand 2040 anuales MWh/yr (11)	longitud de costa Km(4)	Potencial Total annual wave energy TW/yr (12)
Target Market Electric												
Chile	17	3.568	0,10	62.316	5,47%	16	126,70	185,38	130.235	288.060	4.200	1.049
India	1.237	684	309	846.024	2,98%	19			2.009.533	5.101.624	6.000	263
Canadá (6)	35	16.406	s/d	572.239	22,87%	8			757.534	1.024.702	11.000	183
Australia (7)	8	10.720	s/d	90.717	1,85%	21			134.925	338.686	25.760	1.300
United Kingdom (8)	63	5.516	s/d	348.783	10,60%	20	134,17	220,74	439.847	564.676	12.429	230
New Zelandia	4	9.399	s/d	41.665	33,75%	22	94,34	231,76	56.035	77.098	15.134	1.657
USA	314	13.246	s/d	4.158.119	11,99%	12	66,98	118,83	5.258.468	6.771.187	19.924	950
West Coast (5)												250
Alaska (5)												620
Hawaii (5)												80
TOTAL Market				6.119.863					8.786.578	14.166.033	94.447	5.632

Source: Developed in-house

References

- (1) The World bank <http://www.worldbank.org/>
- (2) IEA International Energy Agency 2011 <http://www.iea.org/>
- (3) Key World Energy STATISTICS 2013, International Energy Agency
- (4) http://es.wikipedia.org/wiki/Anexo:Pa%C3%ADses_por_longitud_de_costa
- (5) Mapping and Assessment of the USA Ocean Wave Energy Resource, EPRI, Electric power research institute, 2011// Bureau of Ocean Energy Management (BOEM)
- (6) BEDFORD INSTITUTE of OCEANOGRAPHY, Her Majesty the Queen in Right of Canada, 2009, pag 7
- (7) Copyright Carnegie Wave Energy Limited © 2013// The potential of wave energy, Jenny Hayward and Peter Osman, CSIRO Energy Transformed Flagship, © 2011 CSIRO
- (8) Carbon Trust Foreword to UK Wave Resource Study. Carbon Trust and AMEC Environment & Infrastructure UK Limited October 2012 "
- (9) Nine month average value of the incident wave power is 10 kW/m and peak monsoon average is 20 kW/m, Center for th Research and Environment agement, Cochin 17, India
- (10) Se aplica eficiencia del 32% de Wilefko disponibilidad recurso 50%
- (11) Proyección basada en la tasa de crecimiento PIB promedio de los ultimo 10 años, Banco Mundial
- (12) Recommendations for Chile's Marine Energy Strategy – a Roadmap for Development, Aquatera Ltd, United Kingdom

GENERATION MODEL

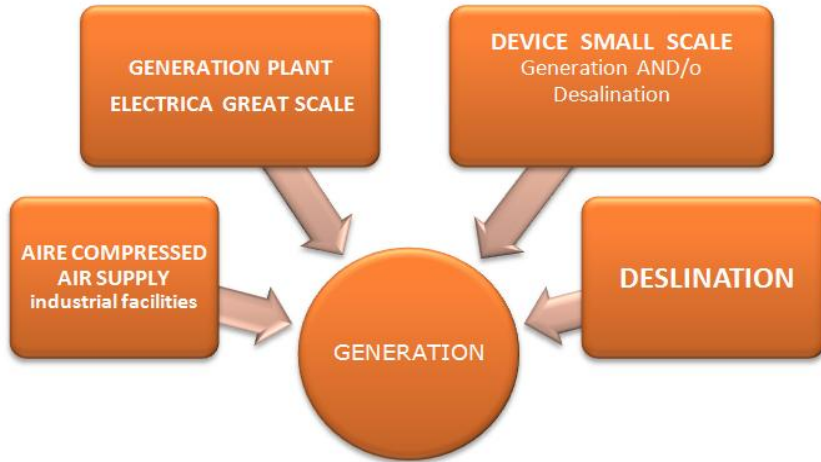

Project Generation great size, Plant to up 20 MW power

National: Free Customers, Generator business, SIC spot market or PMGD, Salmon farms, Mining attributes sale

Annual income : MMUS\$ 22.000, 2010 → 5% ERNC, law 20.257 or 20/25 ~ 23.000GWh/yr

Demand Projection 2020 : 98.000 GWh

Generation half size

- Designed for isolated and insular Chilean areas.
- To generate electricity and / or fresh water. and / or Lighting coastline.
- Location potential 3,500
- Provide water pumping tasks at low cost for aquaculture. (salmon industry).
- coastline lighting for community

POTENTIAL MARKET

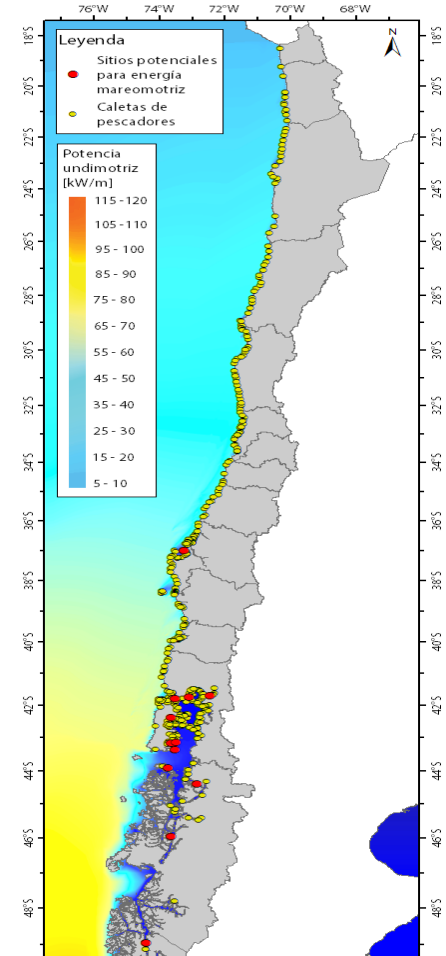

LICENSING MODEL

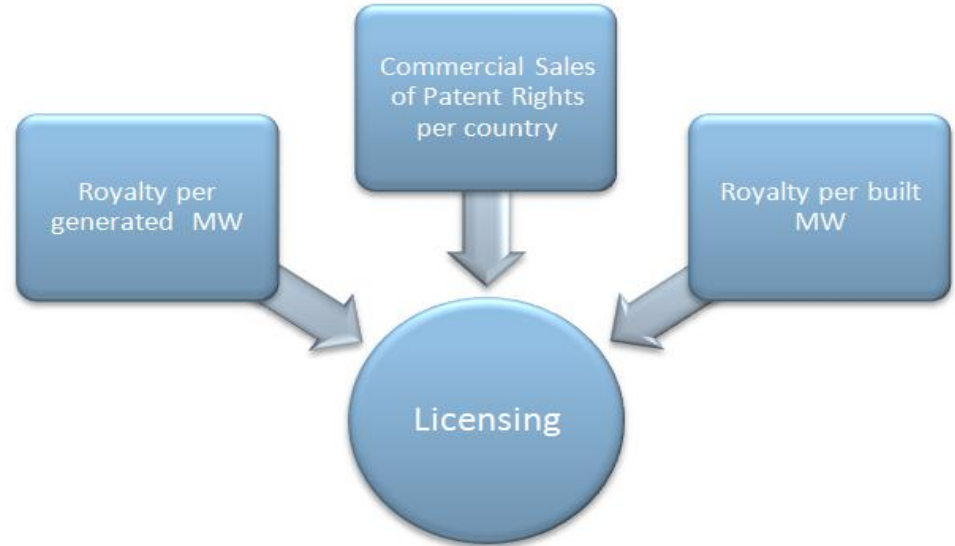

Knowledge is tradable !!

- ↓ Technology Package
- ↓ Patent
- ↓ Trademark Registration
- ↓ Procedures
- ↓ Another Know How
- ↓ Play, Display It, Modify It, Use It

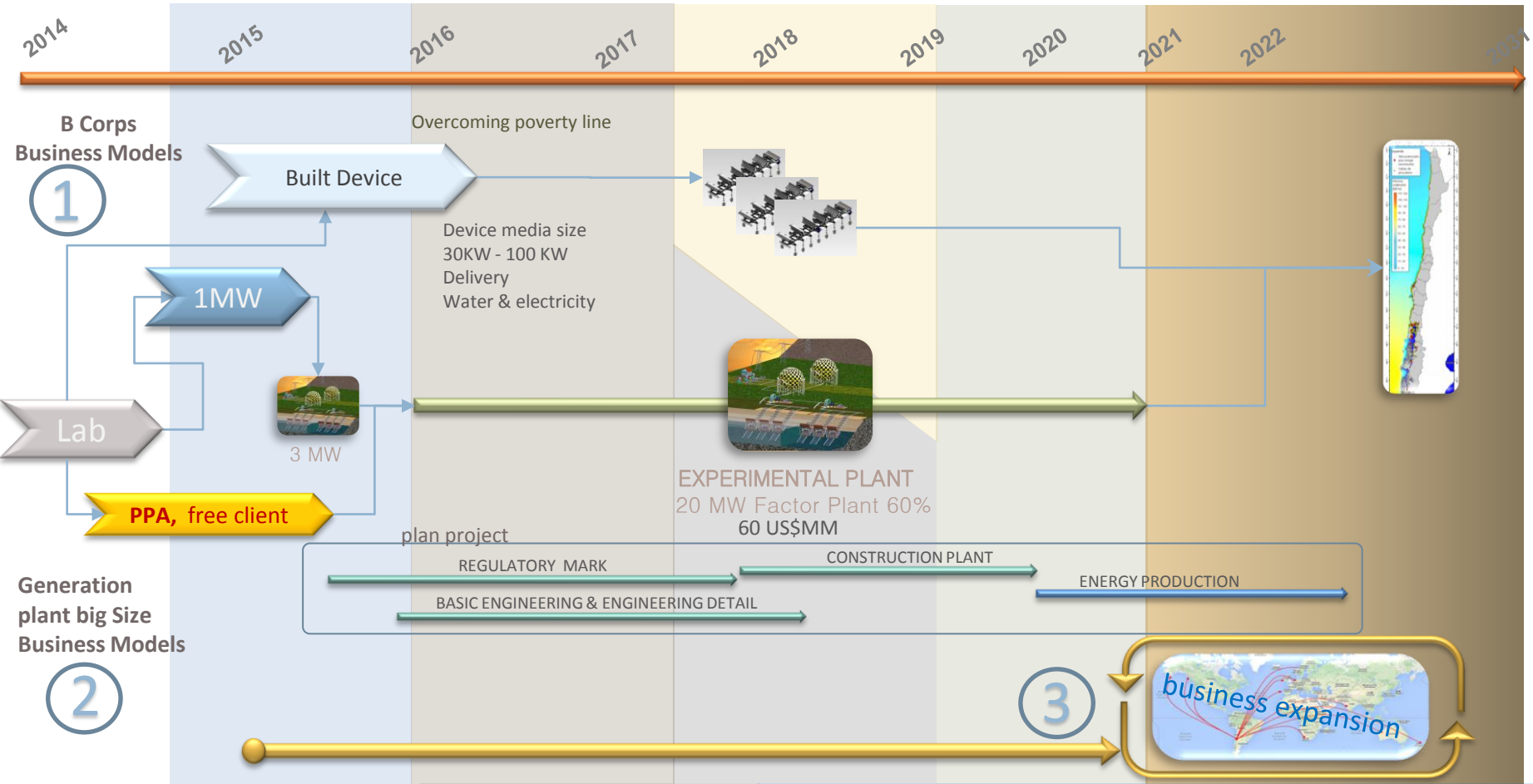

NATIONAL WAVE ENERGY POTENTIAL

12x

NATIONAL POTENTIAL INSTALLED

Tecnología ERNC	Potencial Optimista (MW)	Potencial Conservador (MW)
Undimotriz	240.000	164.000
Solar	228.000	100.000
Eólica	40.000	7.200
Hidroeléctrica	23.000	20.400
Geotermia	16.000	3.300
Biomasa	13.700	470
Minihidro	1.400	1.400
Mareomotriz	800	600
Biogás	400	400
Total	563.300	297.770

Fuente: Estudio UTFSM 2008: Estimación de potenciales brutos al 2015, ENAP 2005, Estudio CNE-GTZ 2008, CNE-GTZ 2007, CNR y MEN 2007-2010, CNE 2009, Estudio Garrad Hassan 2009 y Baird & Asociados.

Sales equipment model

6 train sale palette 100KW power to:

- Compressed air delivery
- Delivery of energy storage
- Pumping seawater
- Energy without storage.
- Factor plant 60%

Sale of energy and power model

- 1MW plan to sell power to the grid under the PMGD or spot market or PPA
- Factor floor 50% -70%
- MW built cost US \$ 3.0 MM
- MWh annual yield for 1 km of coastline 175GWh, with 186 trains per km app.
- Monomic sale price \$ 150 MWh

Alternative products

- Seawater desalination
- Coastal edge lighting





WILEFKO

TECHNOLOGY



By observing nature



[video link](#)

Energy from each wave could be harvested more than once



We have 3 years of research with real tests at sea

Empirical



[video link](#)

Our invention was developed starting from the observation of the behavior of waves in real nature. Once a breaking wave hits an obstacle like columns of a port deck, the wave has enough energy to recover itself from that hit and continues hitting other columns, as it can be seen in any port. So, the idea we worked on was to harvest each wave several times, with group of vertical flaps, arranged as a train facing the breaking waves coming to the coastline.

The whole generation facility is composed of 4 different stages:

1. Harvest stage:

formed by the group of oscillating flaps arranged as groups of trains of flaps running over rails, in front of the coastline, facing the breaking waves. Rails allow adjusting each train to follow tide level. At this stage we just pump water to the beach.

To simplify the figure trains of flaps are not shown in the figure.

2. Compression Stage

Pumped water is used as energy source to generate compressed air, that then is use as an energy deposit of stored energy .

3. The Storage stage

Compressed air is stored as a great warehouse of energy, in a similar approach of hydro electrical dam. To simplify explanation spherical big ponds are shown as part of the facility, but can be replaced in the real project just by the tube pipelines carrying the air to the final consumers.

4. Generation/Distribution Stage (transformation)

Compressed air can be deliver according to commercial agreements, using a pneumatic motor and a generator.

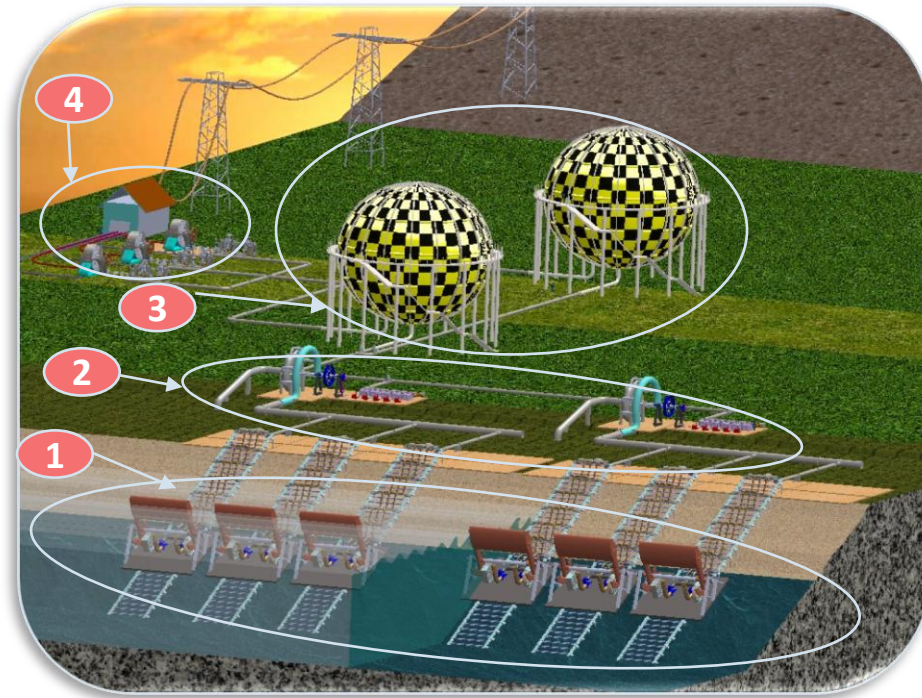

Two direct spin offs are immediately achieved from our concept and invention:

1. Pumped water over the coastline could be used for Desalination projects, cooling application for fan purposes.
2. Compressed air can be commercialized as raw material for a wide range of applications, e.g., mining camps



Waves

Horizontal vector
Wave compression
near coastline

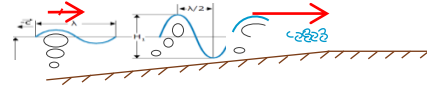

“Water wall” moving at 30 Km/h
800 times denser than air
Energy here is more concentrated



Concave Impact Flap
With flotation

57% efficiency (CFD Star-CCM+)

Wilefko can capture more energy because its is the nearest to the coast compared with the rest. The better power efficiency of our design is obtained from 2 m waves, who in turn are the most predominant wave sizes found in Chilean coastline

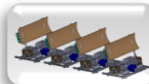

Train of flaps

Successive flaps

$$\sum_{i=0}^n a(1-b)^i$$

a= power; b=% loss,
i=number of flaps

2-3 times wave energy is captures from the same wave, improving harvest efficiency of the coastline



Storage

Available energy according to demand
Higher Firm Energy Factor



Sale price per MW raises from 30% to 200%,



Rails on coastline for the trains of flaps

Allow adjust vertical position of flaps according to tide level
Keep down maintenance costs, avoid use of vessels

Allows 10% efficiency increment
Just 18% of investments in under sea water, thus, lower investment risks









Flexible Business Model

1. With Storage stage → Power Model or stabilization
2. Without Storage → Generation Model
3. Portable devices, with 300KW capacity or lower, for isolated zones or home application over the coastline
4. **Desalination of sea water**

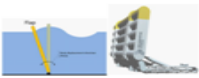
28% of investment with direct generation
At Atacama region there are 74 isolated locations
Los Lagos region: 67 locations with higher isolated index's.

COMPARATIVE CHART

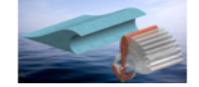
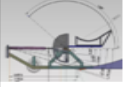
Technology Name	Images	Angular Variation	Flap Design	Surface of Impact	Deep of Operation	Declared Efficiency
Wave Roller Devices		 40°	Medium	26 m wide, 12m high --> 1,6 KW m2 Total unit 500 Kw	10 to 15 m	The efficiency of the hydraulic system is about 60 % (depends of operating point), so 500 kW per unit absorbs about 830 kW from the waves.
Aquamarine Oyster		 35°	Medium	26m x 12m --> 1,5 KW m2 , Total unit 800Kw	12 to 20m	Oyster 800 represents a step change in design, size and power output. The oscillator is about 50% wider (26m) in comparison to Oyster 1, but produces about 50% more energy because of the hydrodynamic design optimization (a)
Bio Power Systems		 35°	Medium	Type-B: 3m x 2.5m x 2.5m, 4kW --> Total unit 1,5 KW m2	12 to 300m	50%
WILEFKO		 135°	High	1m x 1m --> 5,9 KW m2	5 to 10m	57% according to computer aid modeling with CFD Star-CCM+ software
Comments		The type of Wilefko wave palette allows greater rotation	Our concave parabolic shape facing the waves allows Wilefko to concentrate energy from energies becoming a better capture method, see Fig 1.	Capture performance for 1 m ² flap facing 2 m waves, is calculated. 2m wave was chosen, due to the fact that is the most common high found in Chilean coastline, see Fig. 2e, Fig. 1	Depth of the location of generating devices is a key parameter, because in deeper waters maintenance costs are higher	This values are only referential. Capture method of these technologies is unknown.

Source : house and *Energies* 2013, Centre for Marine Technology and Engineering (CENTEC), Instituto Superior Técnico, Technical University of Lisbon,



WILEFKO



INVESTIGATION

how many energy there is available in breaker zone?

Theoretical

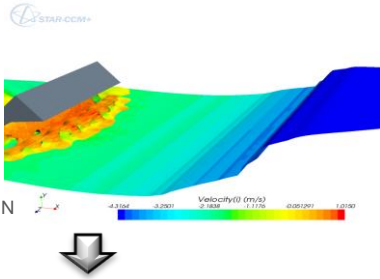

Wave Height : 2 m
 Flywheel inertia Recommended : 60 kg / m2
 Energy : 495 Joule
 Power : 52 W
 Efficiency : 57%

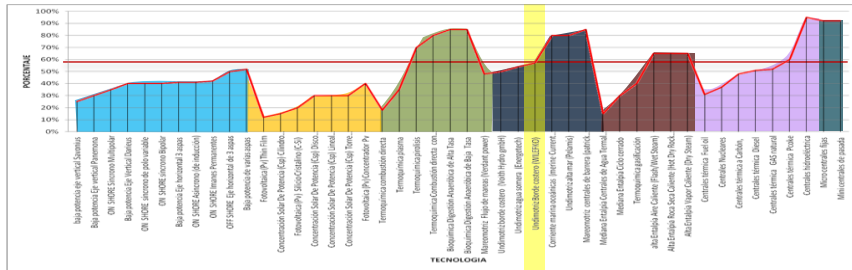

Fuente : Generación propia

- Eólico 40%
- Solar 25%
- Biomasa 62%
- Oceánicas 70% Marea 61% Undi.
- Geotermia 47%
- Tradicional 53%
- Minihidro 92%

Empirical

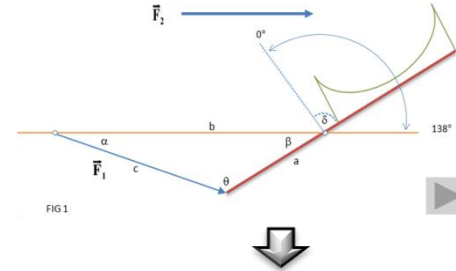

Waves / hours : 392
 Period : 2.3 sec.
 Frequency : 0.106
 maximum Pressure : 24 Bar

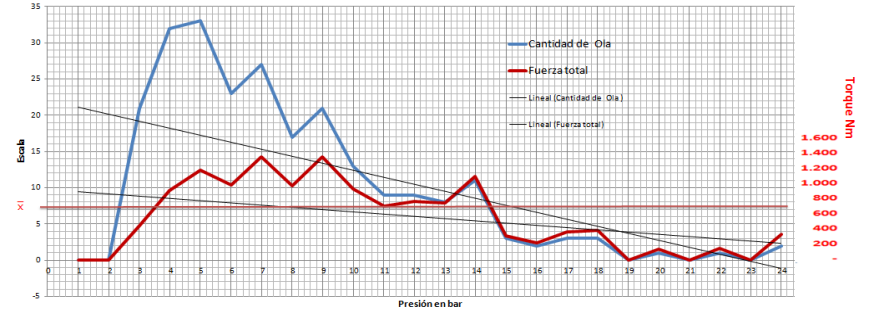

Field Test

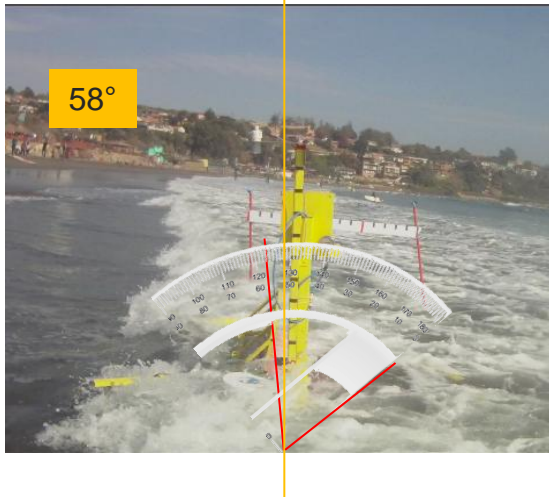
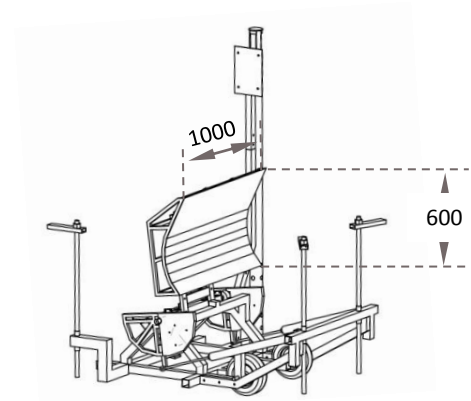

Pressure 5,08 bar

That is, for a wave height of 90 cm with a thrust of 712 kg in less than 2 seconds, and torque of 236 NM, for an area of 100cm x 60cm and 80 cm depth

H (cm)	bar	N	Nm
35	5,03	126	38
60	15,88	441	128
91	24,19	712	213

High power → working depth 80cm

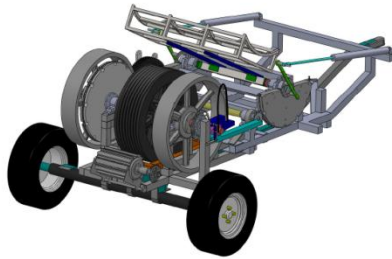

LABORATORY RESULTS

Working pressure	5-6 bar
Simulated wave height	35cm
Flywheel inertia	420 kg
	300 RPM
Power	120W
AC Generator	3kW

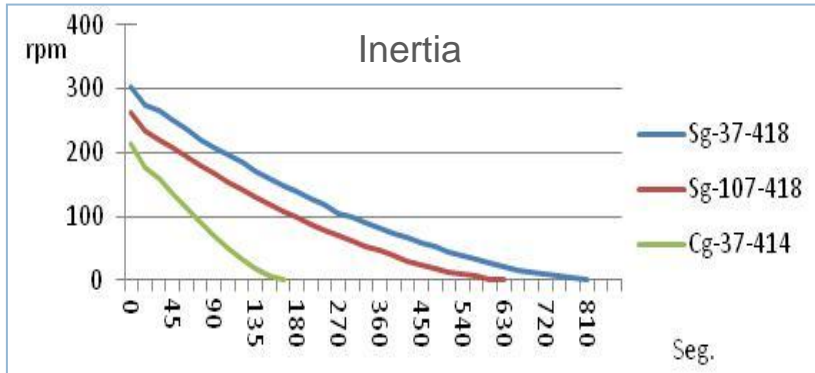

Power messure

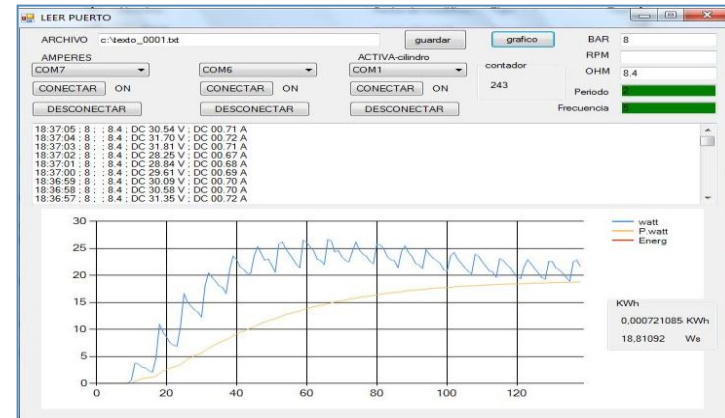

80% of waves in Chile in the range of 1.5m to 3.5m; this determines the flap size

Condition Data Wave

localities 13
 Resolution 3 hours
 Period 2009- 2014
 source: windguru

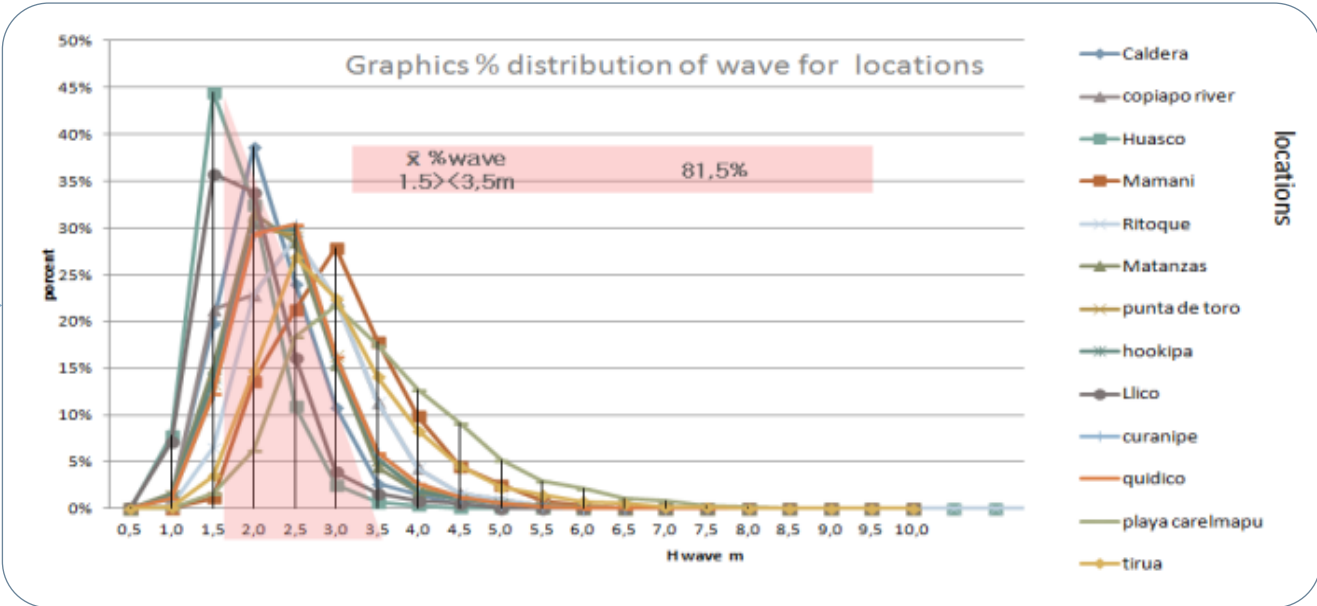
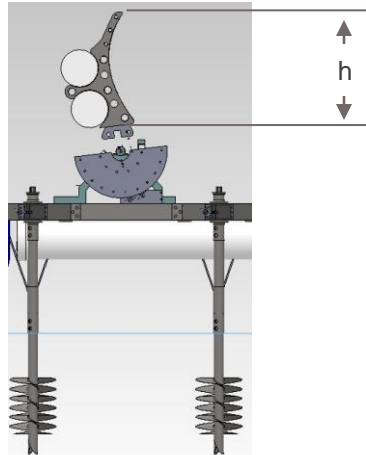

FLAP
 Height 2,5m
 Width 3m

Electricity Projection Average
 Train Power 61 KW
 Energy annual 1078 MWh



WILEFKO

BUSINESS STRATEGY





FINANCIAL VARIABLES

Quantity 2 cluster
Cmg Price \$ 140.00 MWh

CLUSTER 500m coast

Quantity 100 Train
Separation between trains 2m

TRAIN

Quantity flap per train 6 Flap
Re- catch efficiency% 75%

FLAP

Height 2.5m
Width 3m
Lab error factor. 10%

Besides applying available energy, wave forecasting global GFS (NOAA / NCEP) for the last 5 years on 9 locations, our study of wave field trials was calculated, allowing to quantify total energy production if we had 20 MW plant operating

Condition Data Wave

localities 9
Resolution 3 hours
Period 2009- 2014
source: windguru

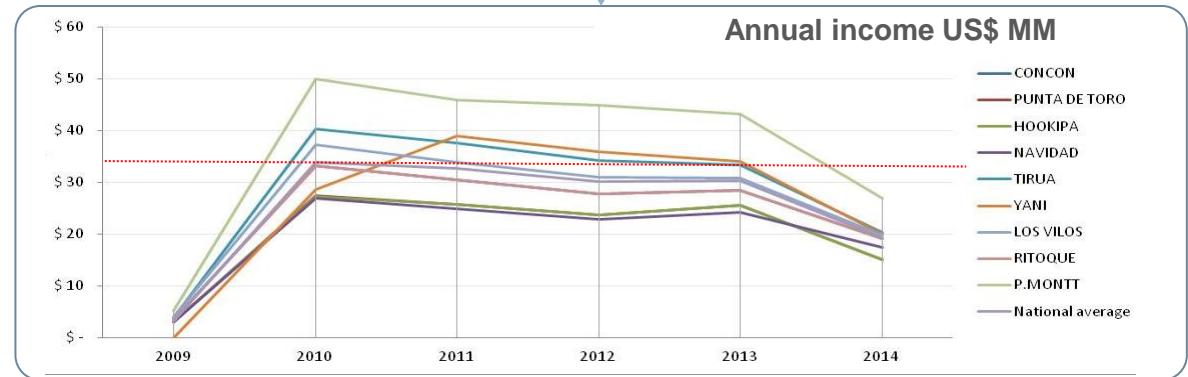
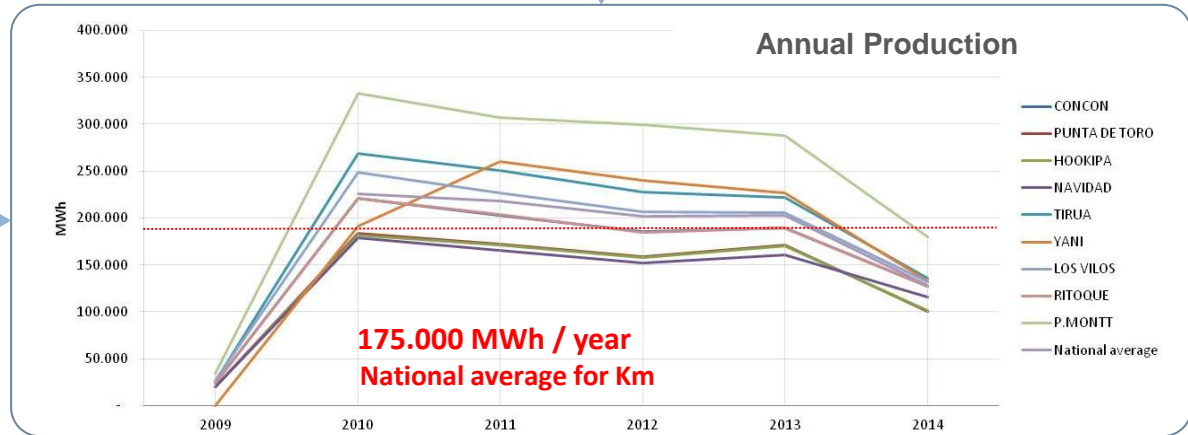

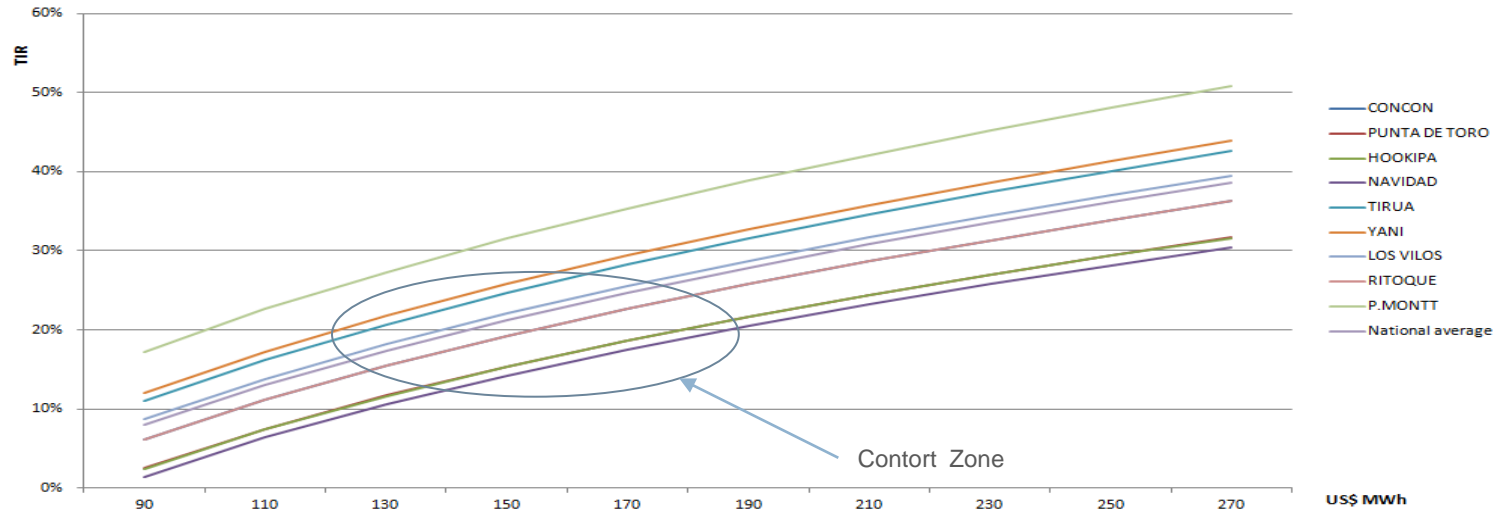

Balance Point
INVESTMENT
U \$ 63 MM

To meet a required return of Business Model Generation at larger scales, 3 variables must be met

- 1 - ± \$ 140 per MWh
- 2 - Availability of power 30 kW per meter.
- 3 - Economies of scale, plant from 20 MW or more.

↓ Substation Quillota 220 kV, average US\$237 MWh , 2014
 ↓ Maximum value in Chile in July 2013 US \$312 MWh

CHILE : SPOT MARKET MARGINAL COST, EVOLUTION & PROYECTION

EVOLUTION

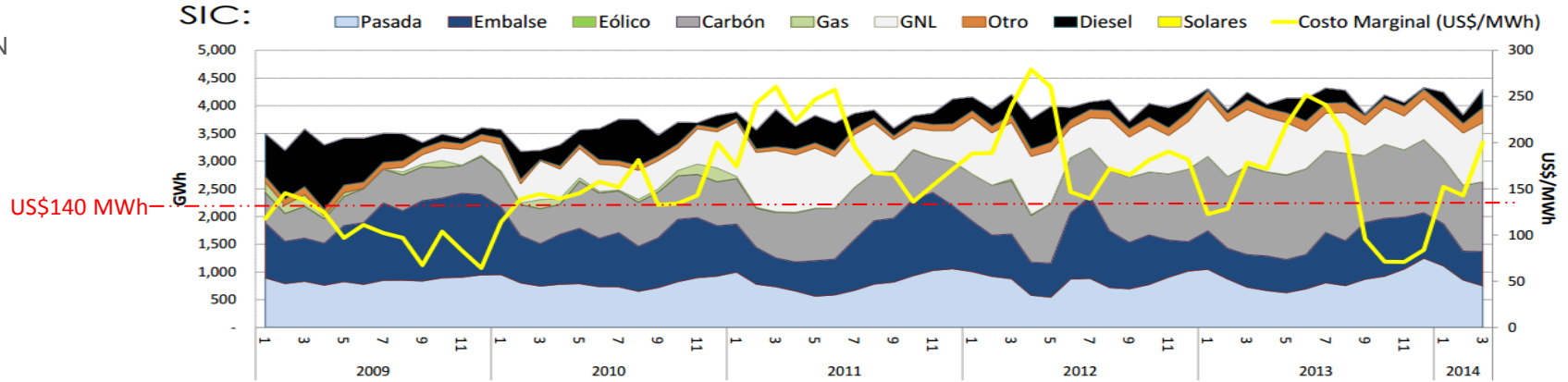

PROYECTION

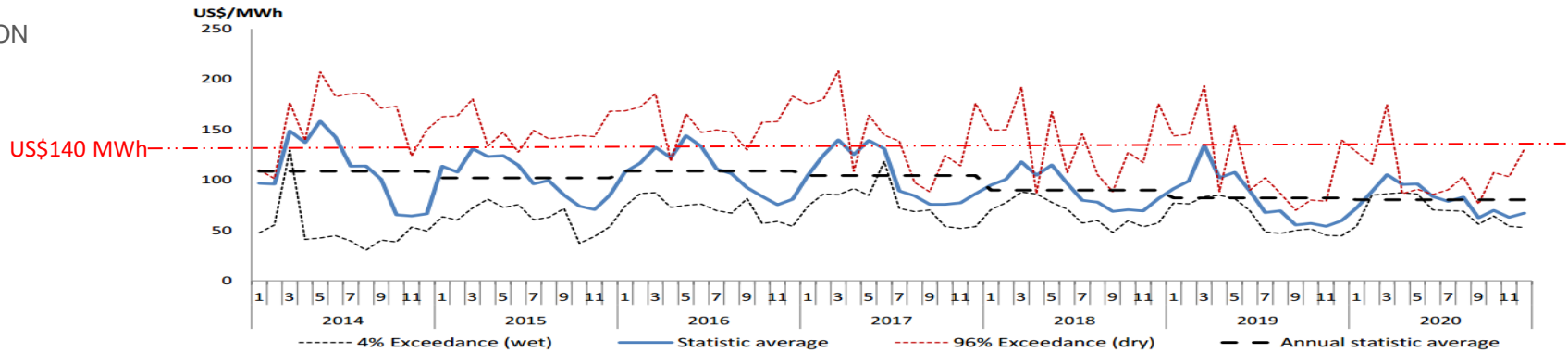

Fuente: Systeop

INTEREST ZONE SELECTION CRITERIA, for Plant 20MW

- ↓ Located from Antofagasta to Puerto Montt.
- ↓ With energy potential over 35 kW per meter coastline.
- ↓ Beach not suitable for swimming, highly dangerous.
- ↓ Surf zones with a width over 100m from the beach shore up to the first breaking wave.
- ↓ Outside the urban area over 10km from city or town limits
- ↓ Inside industrial areas or ports (like mining ports)
- ↓ Maximum 30 km far from a electric power distribution plants.
- ↓ Minimum coastline front length: 1700m
- ↓ Outside of protected or ecological reserves
- ↓ Outside existing maritime concessions areas
- ↓ Maritime zone concessions available
- ↓ More than 75% of waves greater than 2.5m

PRE-SELECTION

Location	Potencial
Los Vilos	→ 33 KW
Punta de toro	→ 54KW
Yani	→ 57KW
Con Con	→ 9 KW, test fields

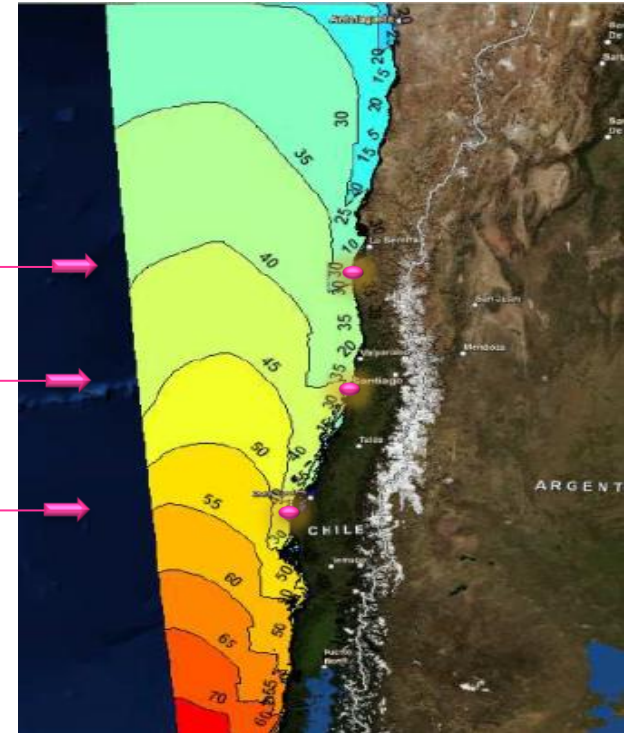

Source Baird

Annual Energy pilot plant in MWh

	2009	2010	2011	2012	2013	2014	TOTAL	Average	Power MW
CONCON	20.206	187.490	172.149	156.609	159.900	107.723	804.079	169.037	19,30
PUNTA DE TORO	17.110	154.606	144.749	132.933	143.690	84.786	677.874	143.995	16,44
HOOKIPA	17.010	153.375	144.336	132.719	143.046	85.087	675.571	143.369	16,37
NAVIDAD	16.828	151.065	139.249	127.686	135.198	97.772	667.799	138.300	15,79
TIRUA	21.714	229.133	213.411	193.856	188.681	114.700	961.495	206.270	23,55
YANI	-	163.243	221.900	204.179	192.992	112.759	895.073	206.357	23,56
LOS VILOS	23.056	211.352	192.336	175.493	174.332	111.848	888.417	188.378	21,50
RITOQUE	20.192	187.828	172.543	156.036	160.099	107.783	804.480	169.126	19,31
P.MONTT	29.503	285.708	262.546	256.209	246.003	152.971	1.232.940	262.617	29,98
National average		191.533	184.802	170.636	171.549	108.381	845.303	180.828	20,64

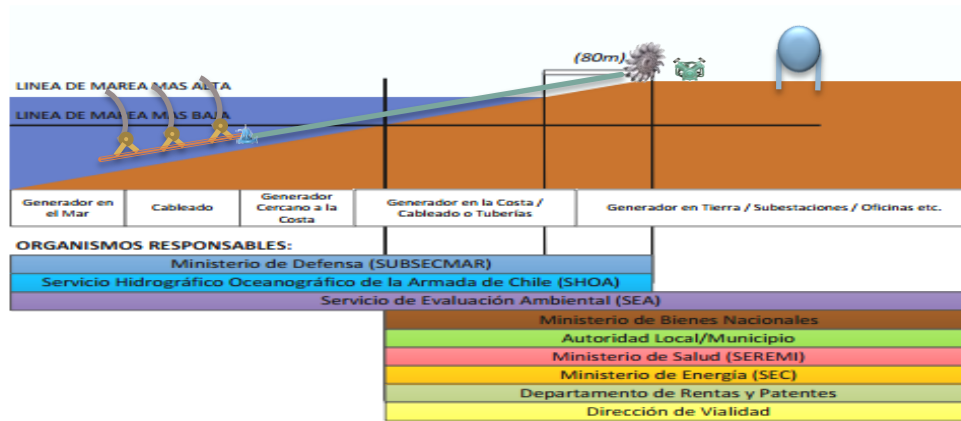

Legislation specifies non existent
Just for approval

Average of processing 3 years

POTENCIALES PERMISOS REQUERIDOS:

- Concesiones Marítimas
- Permisos de Navegación

Declaración de Impacto Ambiental (DIA) o Evaluación de Impacto Ambiental (EIA)

Nota: solo los proyectos de capacidad >3MW requieren presentar EIA para su resolución (Resolución de Calificación Ambiental)

Permiso para arrendar o comprar inmuebles fiscales	varios	varios
Concesión para un uso intensivo de inmuebles fiscales	varios	varios
2. Permiso de Edificación	30	5,000 a 15,000
3. Aprobación De Anteproyecto de Edificación	15	<100
4. Certificado de Informaciones Previas	15	<100
5. Recepción Definitiva de Obras	7	<100
6. Patente Municipal	5	<100
7. Ocupación de caminos públicos para transporte (sobredimensión)	5	<100
8. Ocupación de caminos públicos para transporte (sobrepeso)	5	1,000 a 5,000
21. Informe sanitario	30	5,000 a 15,000
22. Autorización sanitaria para tratamiento/disposición (RISES)	60	<100
31. Autorización Almacenamiento Temporal de Residuos Sólidos	90	5,000 a 15,000
23. Calificación Industrial/Almacenamiento	60	5,000 a 15,000
24. Autorización Residuos Industriales (PAS 91)	varios	1,000 a 15,000
26. Autorización Residuos Industriales (PAS 93)	varios	5,000 a 15,000
41. Concesión Eléctrica Provisional	> 120	5,000 a 15,000
42. Concesión Eléctrica Definitiva	138 a 290	Up a 50,000
art. 138 Permiso de Aguas Residuales	varios	varios
art. 139 Permiso Residuos Industriales o Mineros	varios	varios

Permisos del Ministerio de Salud procesados a través del SEIA

Costos y Plazos Aproximados

Tiempo de Procesamiento de Aplicaciones (días)	Tasas (CLP)
1 a 2 años	15,000 a 20,000
varios	varios
varios	varios
varios	varios
varios	varios
30	5,000 a 15,000
15	<100
15	<100
7	<100
5	<100
5	<100
5	1,000 a 5,000
30	5,000 a 15,000
60	<100
90	5,000 a 15,000
60	5,000 a 15,000
varios	1,000 a 15,000
varios	5,000 a 15,000
> 120	5,000 a 15,000
138 a 290	Up a 50,000
varios	varios
varios	varios

Nota: La numeración se refiere al registro de permisos del Gobierno Chileno



WILEFKO

INVESTMENTS



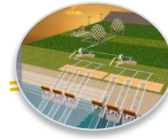
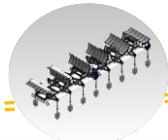

PHASES	Phase-III 30% scale model	Phase-IV Pilot model	Phase-V 20 MW Plants, Chile	Phase-VI Internationalization
COSTO PHASE	US\$ 425K	US\$MM 1.2	US\$MM 63	
INVESTMENTS				
New Partner	US\$K200	US\$MM 1.2	US\$MM 63	
Grants				
PERIOD EXECUTION	Completed 85%	18-24 month	4-5 years	
COMERCIALIZATION		PPA Local Industrial small	PPA Local Industrial	LICENCIAMIENTO International Patent
Intermediary sub products		LICENSING International Patent	Potential joint venture development of technology Cristian Peralta, Antofagasta Minerals (AMSA)	GENERATION ROYALTY CONSTRUCTION ROYALTY
		PORTABLE DEVICE Generation and/or desalination		

FIRST STEP



WILEFKO SpA

■ CEO
 ■ Engineers team
 ■ Other
 ■ Partner Technologic

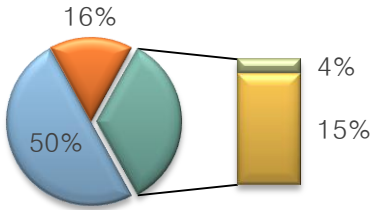

Research & Development

SECOND STEP



Business Model Energy Generation

PLANT 20MW
SHARE DISTRIBUTION

■ Wilefko SpA
 ■ Financial consultant
 ■ Inversor

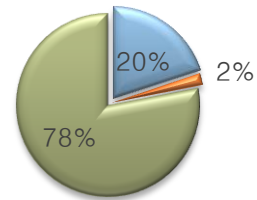

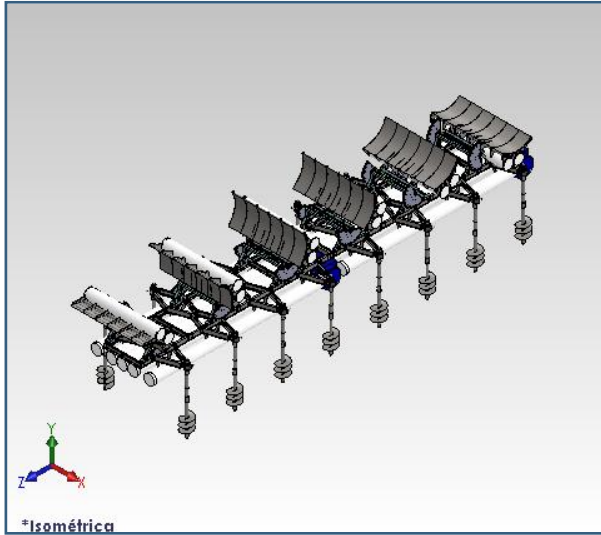

100 KW

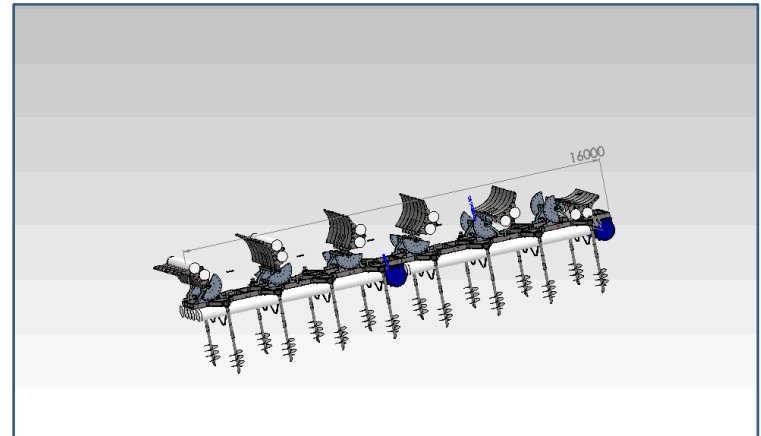

- ↓ Mid-size generation or desalination device
- ↓ Mid-size generation device, for coastline lightning of Chilean ports, coastal counties and regional governments.

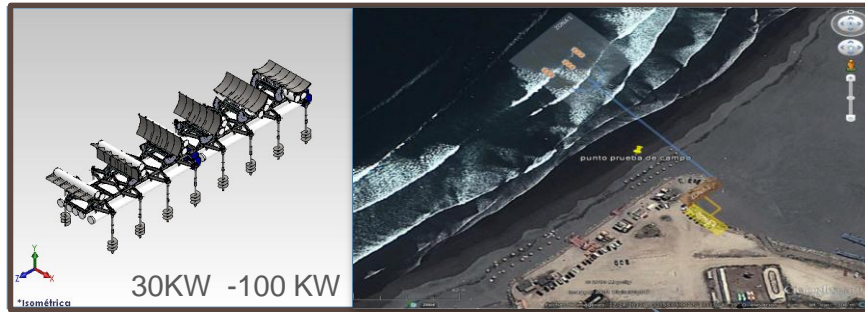

DESALINATION

PERFORMANCE	
Day	223 m3
L/seg	2,58 litros
Impacto	1.486 Personas

AIR COMPRESS

PUBLIC ILLUMINATION

PERFORMANCE	
Potencia Led	180 W
Proyectores	67 unidades
Impacto	1,5 Km

ELECTRICITY

PERFORMANCE	
Producción anual	1.078 MWh
Potencia	61,52 KW
Factor planta	50%
Impacto	15 Casa 4 persona



WILEFKO



OUR COMPANY



WILEFKO, stands for "shimmering" in Mapudungun, is a wave energy project that will generate clean electricity by extracting the kinetic energy of ocean braking waves

We are an Investigation, Development, Innovation and Endeavour project (I+D+i+e). We were made up as company under the form of Society per Actions (SpA), in April 2013, with the initial contribution of 6 charter members

Vision

To be a company recognized because of the innovation and contribution to the clean and renewable energy, positioning the Chilean human capital in the world in this matter.

Mision

To be the first wave power technology with commercial application in the national energy matrix, and one of the leaders with real industrial application worldwide.

Brief History

- ↓ **March 2011:** Wilefko is born, from the very first ideas outlined with a pen in a paper napkin.
- ↓ **January 2012:** we got the INNOVO sponsorship, from Universidad de Santiago de Chile (USACH).
- ↓ **September 2012:** Consist in a team of 12 engineers and technicians, engaged with the project, sharing their specific knowledge to get success.
- ↓ **October 2012:** the projects won government funds from CORFO, for U\$D 300.000.-
- ↓ **December 2012:** second international search report from World International Patent Office, WIPO, declares that Wilefko project has Novelty, Inventive Activity And Industrial Application. EXCLUSIVE RIGHT, 27 countries
- ↓ **2012,2013:** three field trial at Con-Con beach, Chile,
- ↓ **October 2014:** Publication of laboratory results in **First Workshop on Wave and Tidal Energy**, organized by the University of California at Berkeley and Universidad Austral de Chile [see video](#)



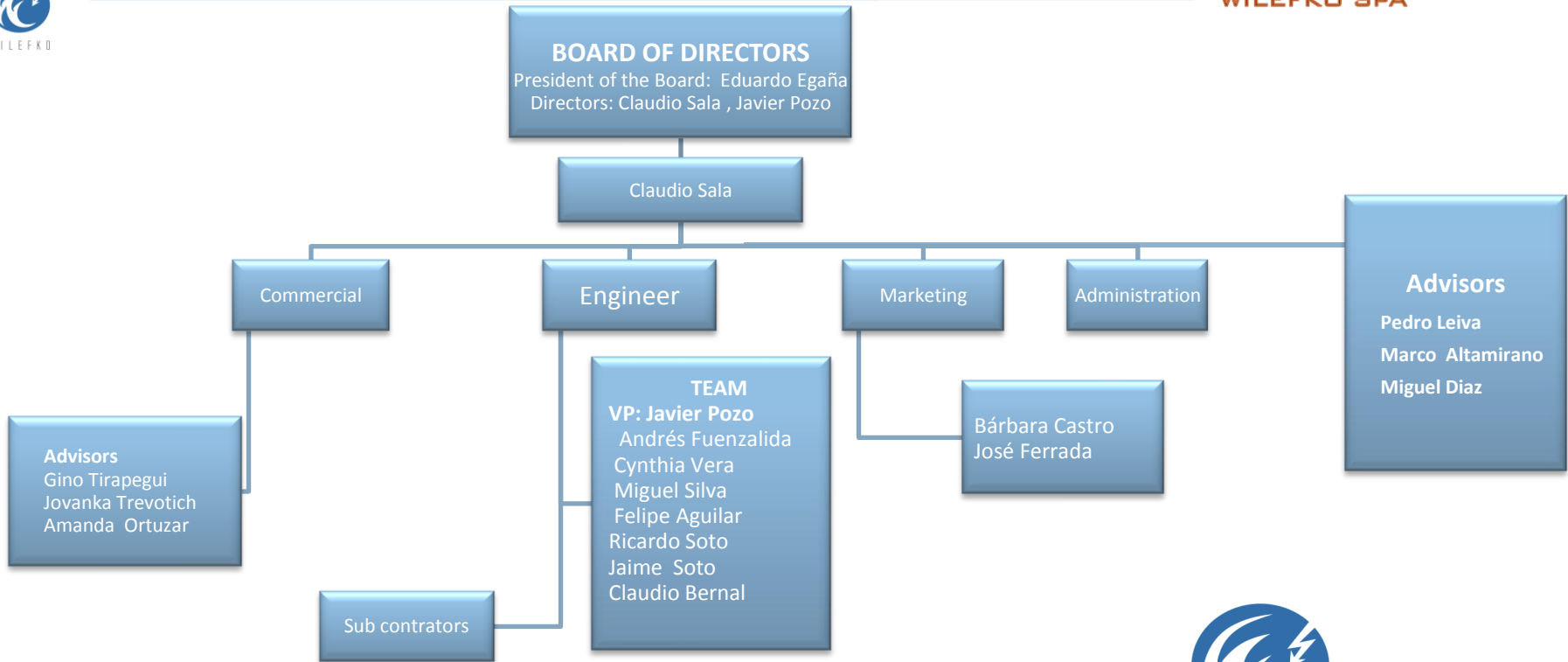

↓ Company WILEFKO SpA
 ↓ Org. Id (RUT) 76.299.674-K
 ↓ Business Area NCRE R&D, Generation
 ↓ Address Providencia 1765, of 307, Providencia Santiago, Chile
 ↓ Founded 17 abril 2013
 ↓ Contact contacto@wilefko.com
 ↓ Web Site www.wilefko.com





WILEFKO

CHIEF EXECUTIVE OFFICER



Eduardo Egaña, Computer Engineering at Universidad del Norte, Diploma entrepreneur Universidad de Santiago, Chile. 17 years as owner/manager at DPA computer, creating and offering to the market, 16 different complex Systems, and electronic control equipment. It was pioneer in: 1) Integration of multiplatform system, 2) Developing multi-poll devices, 3) Developing a POS system based on touch-screens for Festival de Viña 4) Various products marking trends in the field of automation.

In 2011 invents and initiates the wave energy entrepreneurship project to generate energy from the sea, with the aim of contributing to clean energy. Formed a team of 18 people, including engineers and technicians, and was able to raise \$ 300 of governments funds supported by CORFO INNOVO, an incubator of Universidad de Santiago, Chile.

Eduardo.egana@wilefko.com Phone : (56+9) 9884 1349

DIRECTOR & BUSINESS RELATION



Claudio Sala, Universidad Adolfo Ibáñez: MBA Executive (Management and Administration), Universidad de Chile: Civil Electrical. CIISA: System Engineer. Update seminars at Berkeley University (California) and Harvard University (Cambridge, MA.).

35 years of experience leading complex projects covering negotiation, monitoring and management of complex IT services. Relevant experience dealing with outsourced contracts with the largest IT providers from Chile, Brasil and Argentina. Extensive experience leading teams of IT in these countries, more specific treatment in Brazil, Peru and Colombia. It uses the expertise as leverage IT Business Development with strong focus to work with highly motivated teams (Human Capital Approach).

Extensive experience in complex environments internal and external political management, in hostile environments and adverse scenarios for the implementation of corporate technological changes of high impact on the organization.

Today, works as leader and responsible for the introduction of innovation environments in one of the larger universities of Chile, creating there an innovative eco-system of co-working, at Universidad San Sebastian, Santiago, Chile (30.000 students)

Claudio.sala@wilefko.com Phone : (56+9) 6728 9794

JAVIER POZO Mechanical Civil Engineer, Universidad de Santiago. 8 years of experience

8 years experience in engineering projects, he has participated as Mechanical/Piping Engineer, PDMS administrator/coordinator and 3D specialist, in steps of basic feasibility of complex projects; basic and detail engineering of projects in the fields of Bigger Mining and Pulp Camps. Strong experience EPCM mining participating in Copper, Gold and Nickel mining camps in the areas of Material Handling, Process Plant, Port-Site, and Plant Lixiviación SX.

Experience in software management with broad domain of Aveva PDMS, Navisworks Autodesk, Aveva Review, Bentley AutoPIPE, 2D AutoCad and MicroStation V8. Experience in calculation and modeling of parts and mechanical assemblies with advanced mechanical design software 3D (Autodesk Inventor Pro, Solidworks and Solid Edge). Current job: AMEC, Manager and Coordinator PDMS 3D.

CYNTHIA VERA Mechanical Civil Engineer, Universidad de Santiago. 8 years of experience

Eight years of Mechanical Engineering experience in Engineering: pulp and paper, smelting and concentrators of copper mining; and Field experience as piping field engineer in the construction of a concentrator plant.

Performed in various technical, supervisory assignments in mechanical and piping systems design, engineering development, construction and start up projects, work with international standards as ASME, AWS, ASTM, ANSI, ISO, API, BS, EN, DIN, AWWA, Etc. Good interpersonal skills and experience of working in multi-international project teams. Actual position: Bechtel Chile and Fluor Daniels.

ANDRES FUENZALIDA, Industrial Civil Engineer, Universidad Diego Portales. 10 years experience

Strong experience in the electric energy and thermal fluids fields, with experience in the areas of renewable energy, thermodynamics, electrical laws, national electricity market as energy efficiency consultant (National Standards Institute). Consultant and project manager at Energy Efficiency validated by INN. Innovation Award 2007 by Dalkia International, Paris – France 2007, for variable business model in selling industrial steam and dairy products. Achieving returns of over 15%. Development machine to generate electricity from the ocean waves. Actual position: FUENZALIDA And SANTIS LTDA.

MIGUEL SILVA CORTEZ, Industrial Mechanical Technician Universidad Técnica Del Estado. 35 years experience

Extensive experience in maintenance of equipment and machinery in Transportation, Mining and Fishing Fleet and marine vessels. Experience in mining camps at BHP Billiton (Minera Escondida Leeds), Superintendent of Maintenance Workshops Mina. (15 years)

FELIPE AGUILAR (PHD) Physic Engineer Universidad de Santiago. 6 years of experience

Doctor , Ecole Normale Supérieure de Lyon, . Academic and Investigador at Universidad de Santiago, Chile



WILEFKO

CYNTHIA VERA

Mechanical Civil Engineer,
Universidad de Santiago.
8 years of experience

JAVIER POZO

Mechanical Civil Engineer,
Universidad de Santiago.
8 years of experience

CLAUDIO SALA

Electric Civil Engineer
Universidad de Chile
MBA UAI, Innovation Diploma USS
30 years of experience

ANDRES FUENZALIDA,

Industrial Civil Engineer,
Universidad Diego Portales.
10 years experience.

MIGUEL SILVA CORTEZ

Industrial Mechanical Technician
Universidad Técnica Del Estado.
35 years experience

BARBARA CASTRO

Costume Designer
Universidad Técnica Inacap
Post grade ESDI , Barcelona
12 years experience

PEDRO LEIVA

Attorney
Universidad Diego Portales .
Candidate to Master in Law,
University of California Davis
6 years experience

MARCO ALTAMIRANO

Attorney
Universidad Católica de Valparaíso.
6 years experience

FELIPE AGUILAR

(D) Physic Engineer
Universidad de Santiago.
6 years of experience

RICARDO SOTO

Electric Civil Engineer,
Universidad Austral.
20 years of experience

JOVANKA TREBOTICH

Biochemical
Universidad de Santiago
MSc Gestión Tecnológica
4 years of experience

CLAUDIO BERNAL

Hydrography – Oceanography
Academia Politecnica Naval
11 years of experience



Third field tests

JAIM E SOTO

sub official Navy
tactical diver.
20 years of experience

AMANDA ORTUZAR

Tec. Ambiental,
U. de Federal de Minas Gerais
2 años

MIGUEL DÍAZ

Attorney
Universidad del Desarrollo
Magíster en Derecho Tributario, UDD
6 years experience

DAGOBERTO CASTRO

Docente Phisic aplic (r)
Universidad de Santiago.
30 years of experience

Collaborators

Mauricio Egaña,
Ing. eje informática

Diego Silva,
Ingeniería ambiental,
USACH

Fabiola Díaz,
Ing. en Financiero

José Luis Menares
Documentalista

Daniela Molina,
Actriz, ecologista

Carlos Wittersheim
Constructor Civil

JOSE FERRADA

Publicist
Universidad UNIAC
3 years of experience

EDUARDO EGAÑA ,

Entrepreneur, Inventor,
Informatic UCN,
Diploma USACH
20 years experience



Parque la Boca
Concón

Multus Industriales
<http://www.wittersheim.cl>

Este proyecto es desarrollado con aportes del fondo de innovación para competitividad



WILEFKO

MILESTONES

MULTIPLE ACTIVITIES



EXCLUSIVENESS RIGHTS OVER THE TECHNOLOGY UNTIL YEAR 2031, IN CHILE AND WORLDWIDE

PI/GL 2011/02154 WO/2013/029195
NATIONAL AND INTERNATIONAL RESEARCH REPORT DECLARES
THAT WILEFKO INVENTIONS GATHERS:

- ✓ NOVELTY
- ✓ AN INVENTIVE STEP
- ✓ INDUSTRIAL APPLICATION.

27
COUNTRY



ACTIVITIES FOR TECHNOLOGY PROMOTION

Publications



Books



TV



Participations



International Publication



Radio



Invitations



Next



ENTREGAR UN MUNDO MEJOR PARA LAS FUTURAS GENERACIONES



WILEFKO

wilefko.com



Se parte de este proyecto Contacto@wilefko.com

Chile



2015



WILEFKO

WAVE ENERGY

*EXTRACTING KINETIC ENERGY FROM
OCEAN BRAKING WAVES*

Thank very much



EDUARDO.EGANA@WILEFKO.COM
CLAUDIO.SALA@WILEFKO.COM
INFO@WILEFKO.COM

2015

Proyecto apoyado por
CORFO
suerte empresa crece

